

6+

◎ RoadLegend

EVOPLAY



ПОДВИЖНЫЙ
МЕХАНИЗМ



ПРОЧНАЯ
КОНСТРУКЦИЯ



ДВИЖЕНИЕ
НА 360°



РАДИО-
УПРАВЛЕНИЕ

CR-004C

380 деталей

CaDFI Double E

Информация об аккумуляторе:

1. Пожалуйста, вынимайте аккумулятор из игрушки, если не планируете ее использовать долгое время.
2. Не соединяйте контакты аккумулятора во избежание короткого замыкания.
3. Заряжайте аккумулятор только в присутствии взрослых.
4. Не оставляйте аккумулятор рядом с открытым огнем или другими источниками тепла, в воде, в доступности прямых солнечных лучей.
5. Никогда не пытайтесь заряжать не перезаряжаемые батареи.
6. Утилизируйте аккумуляторы в соответствии с нормами местного законодательства.
7. Не выбрасывайте аккумуляторы вместе с бытовыми отходами.

Инструкция по синхронизации пульта радио управления (2.4Гц)

1. После установки аккумулятора в игрушку, батареек в пульт и включения обоих, индикатор на пульте начнет мигать. Это означает, что пульт синхронизируется с игрушкой. Когда процесс завершится, индикатор перестанет мигать и выключится.
2. Один пульт может подключаться и контролировать только одну игрушку.
3. Если пульт управления в течение одной минуты не получает ответный сигнал от игрушки, он автоматически уходит в спящий режим (индикатор перестает мигать). Чтобы вернуть его в режим синхронизации, необходимо нажать любую кнопку на пульте.
4. Чтобы прервать соединение между пультом и игрушкой, необходимо выключить оба устройства. После этого, пульт управления можно синхронизировать с другой игрушкой.

Изготовитель: TAIZHOU WANCHANG ELECTRONIC TECHNOLOGY CO., LTD

Адрес: Room 906, B1, Daziran Building, Tang Jia Qiao Road, Wenzhou, Китай

Импортер: ООО «КОМПАНИЯ ВИКАР»

Адрес: 125362, Российская Федерация, г. Москва, улица Свободы, дом 17

Уполномоченная организация по принятию претензий: ООО «Максимэйн». Адрес: 117105, Российская Федерация, Варшавское шоссе, д.37А, офис 107

Основной конструкционный материал: пластик.

Страна происхождения: Китай

Дата изготовления: май 2017

Срок годности: не ограничен.

Срок службы: 10 лет

Специального ухода не требуется.

EAC



0-3

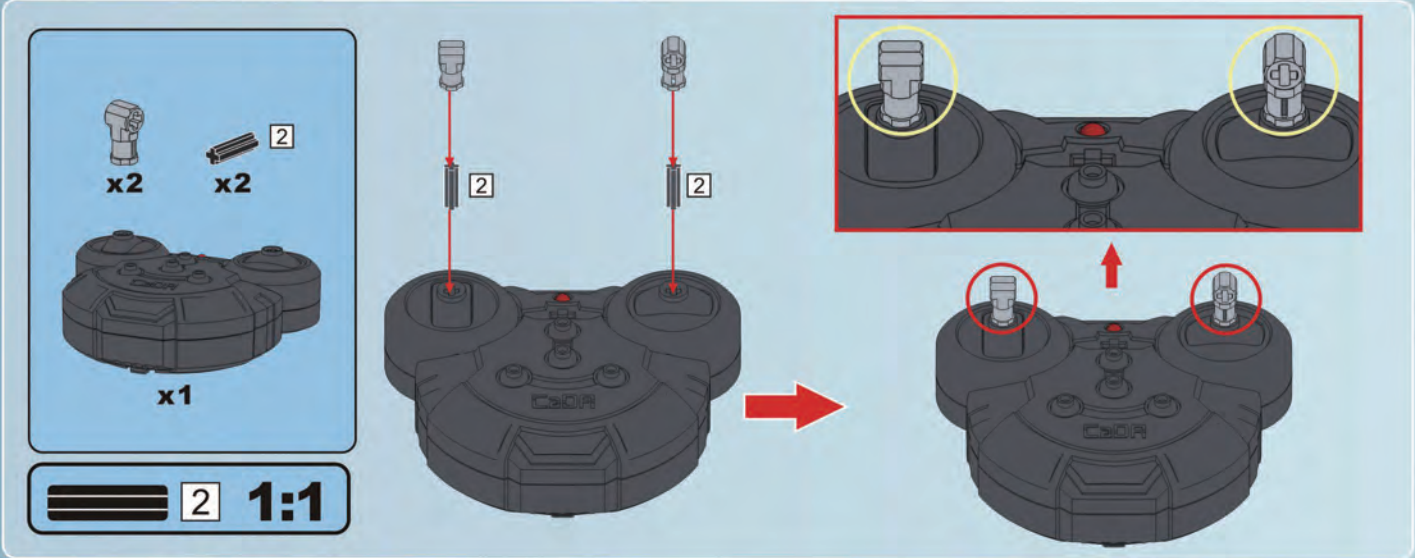
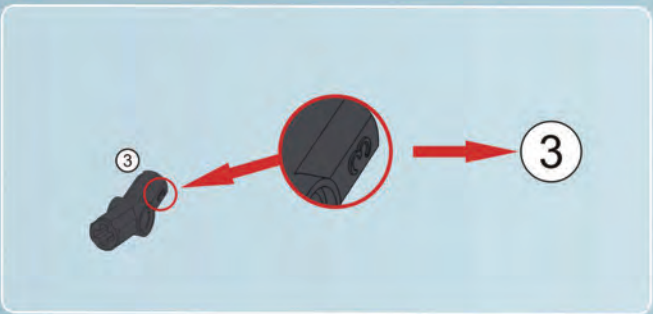
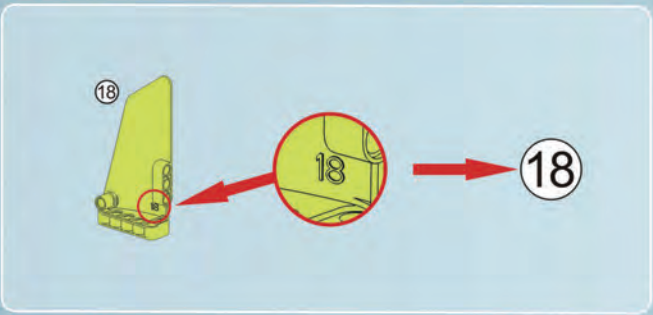
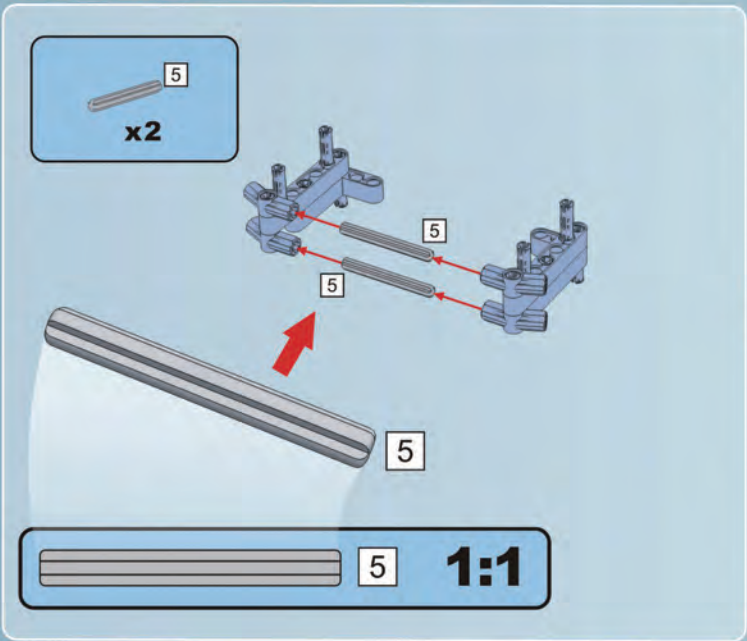

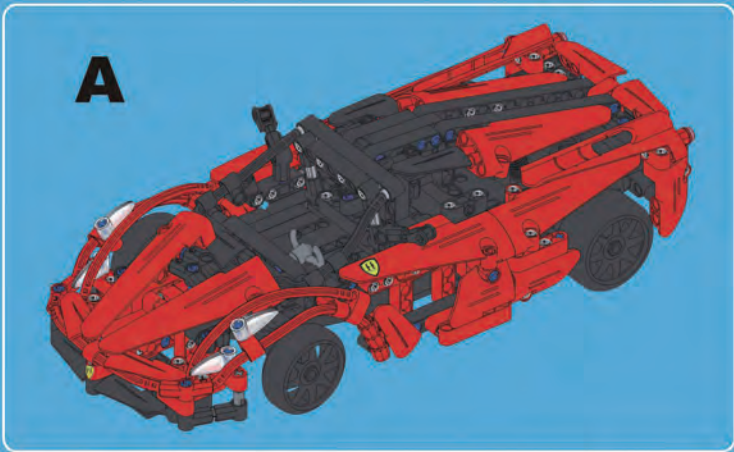

A2

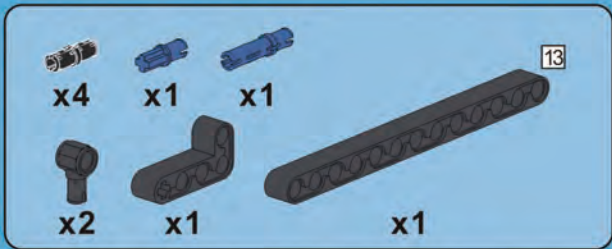
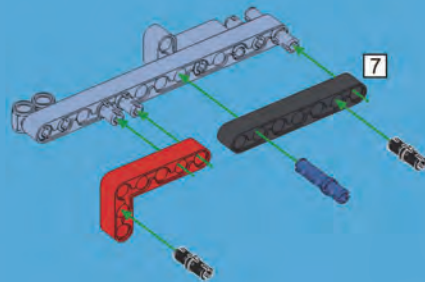

A1

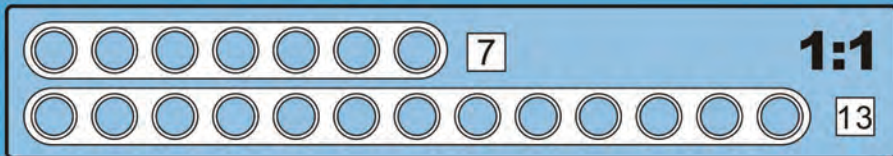
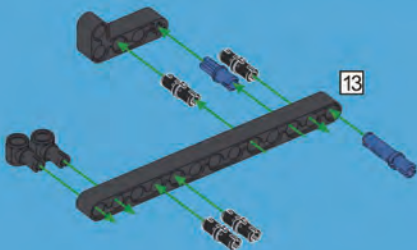

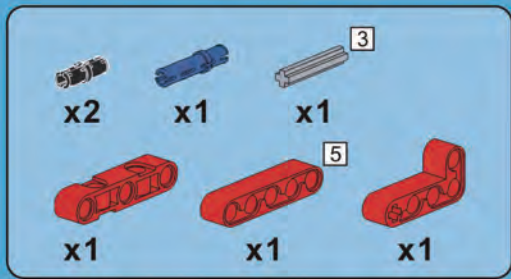

A3

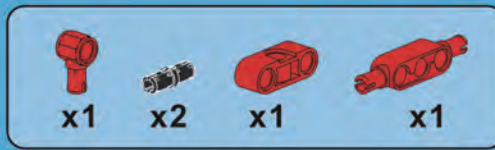
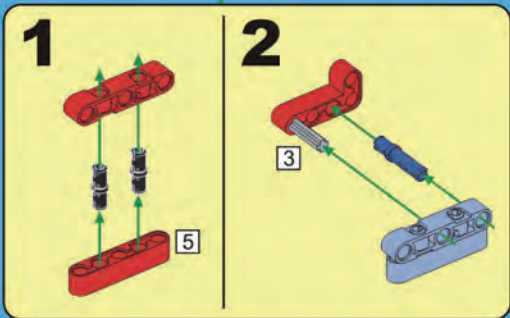
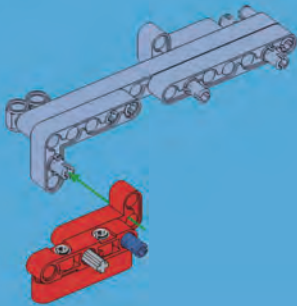

A4

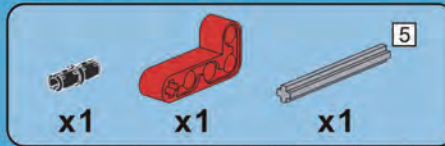
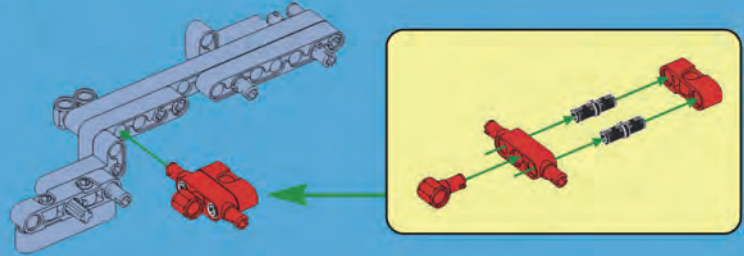

A5

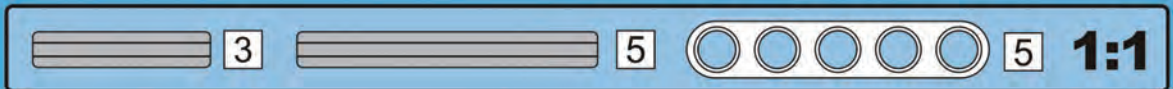
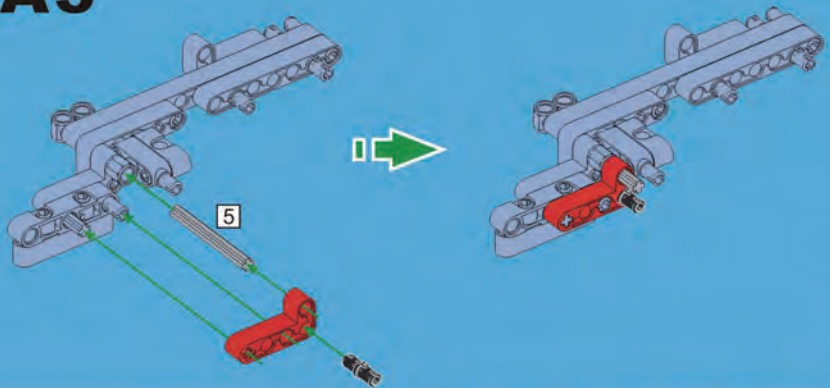

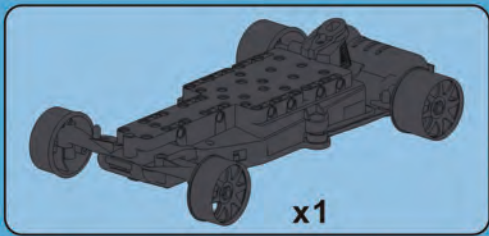

A6

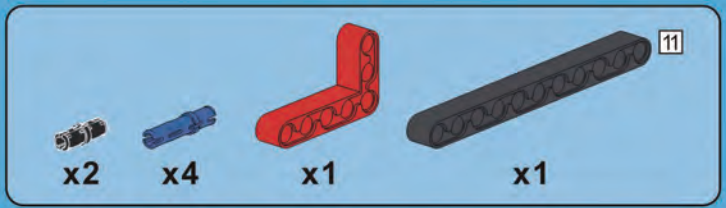
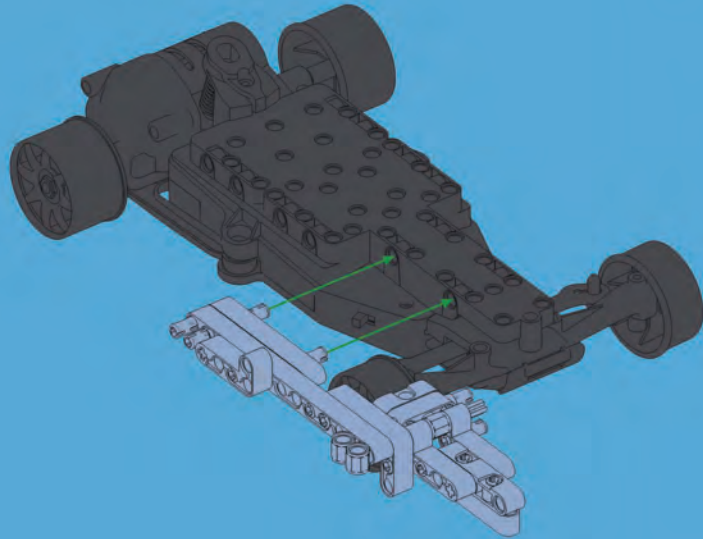

A7

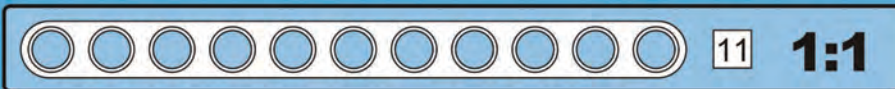
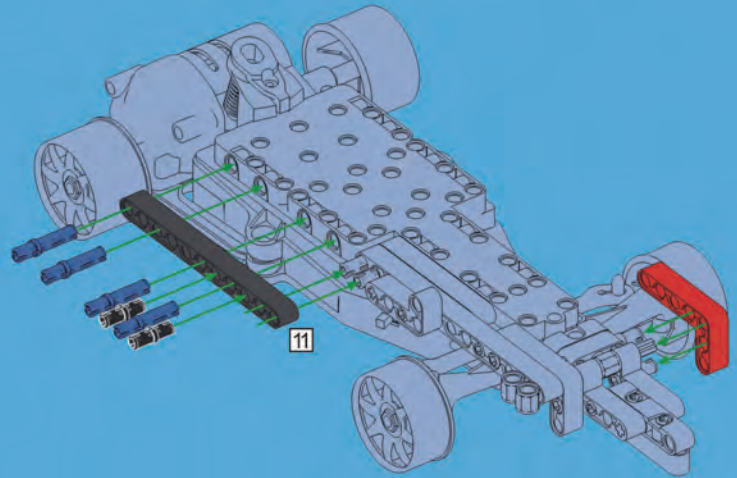

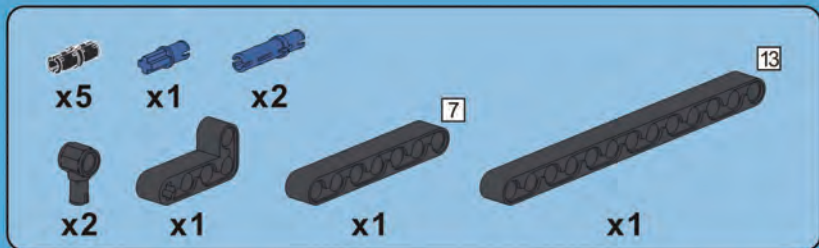

A8

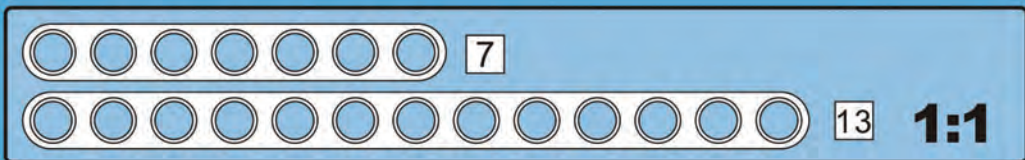
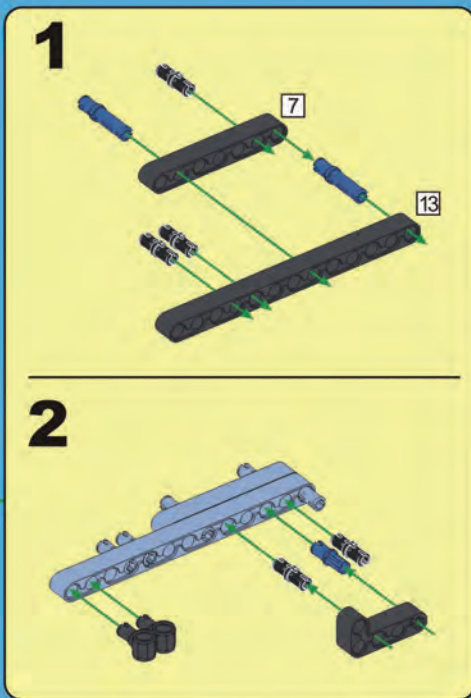
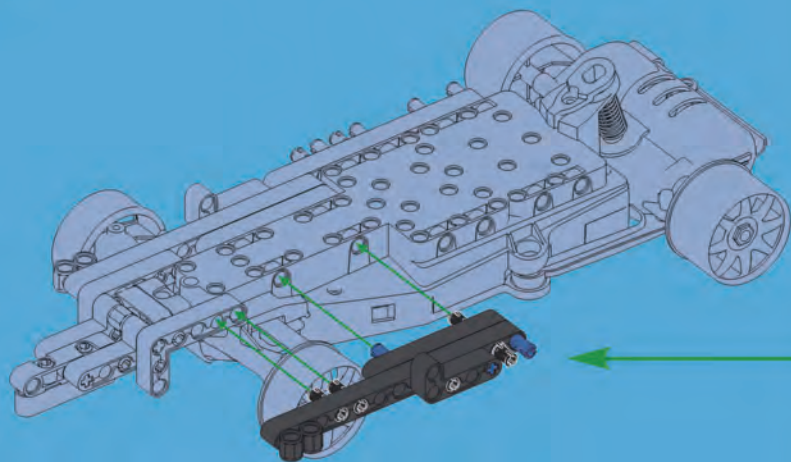

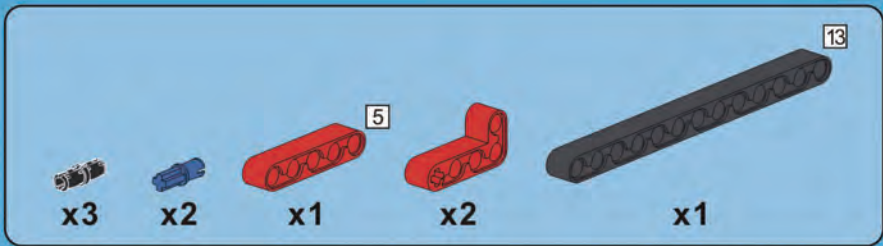

A9

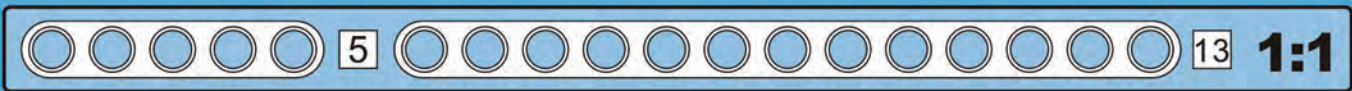
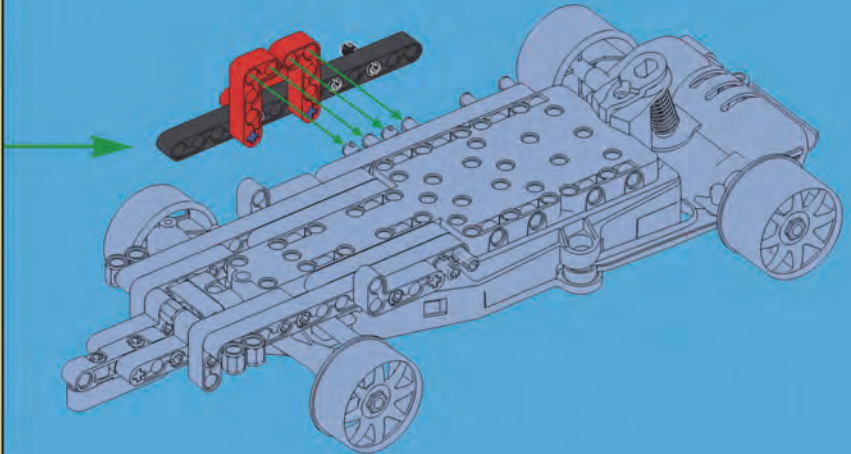
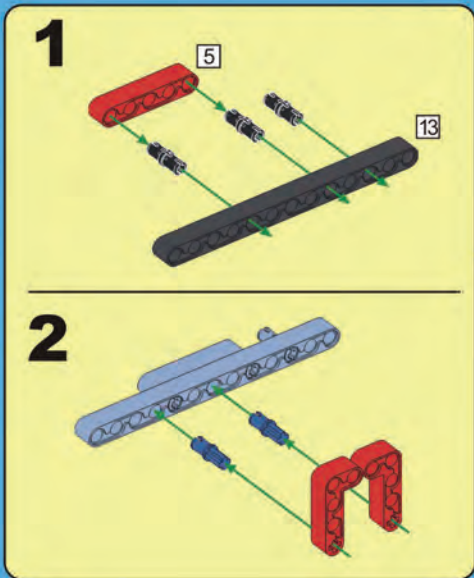

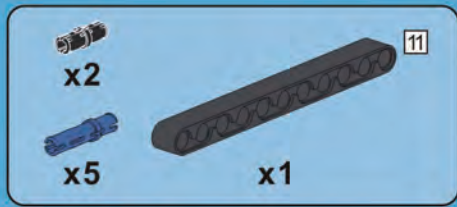

A10

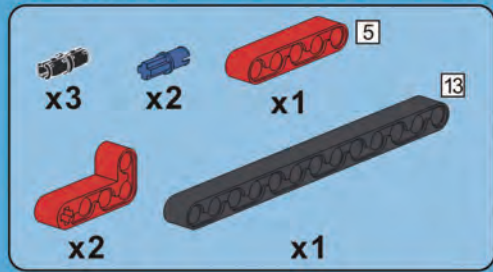
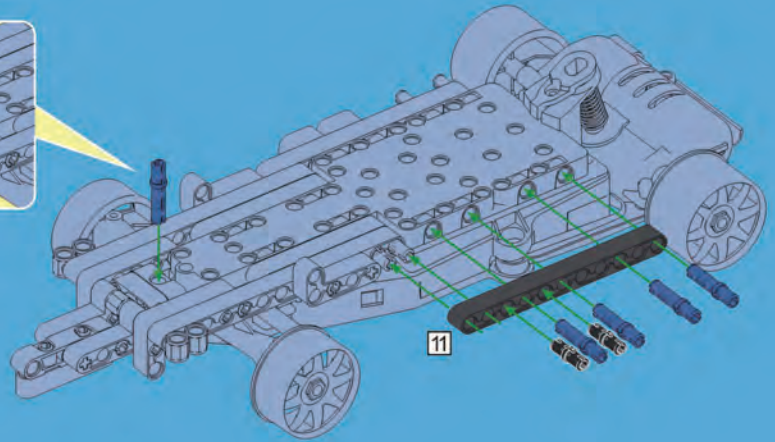
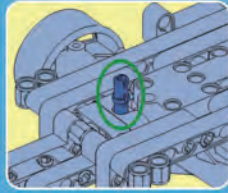

A11

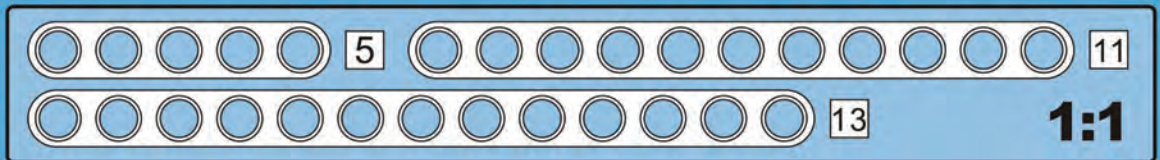
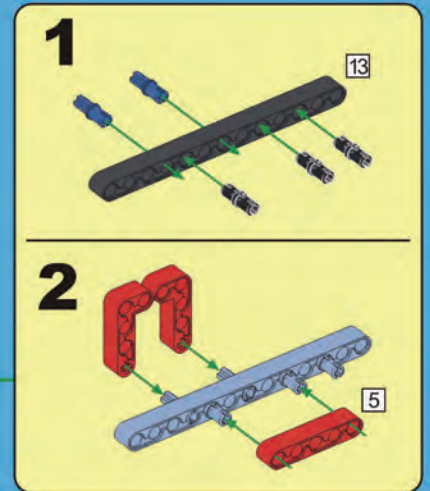
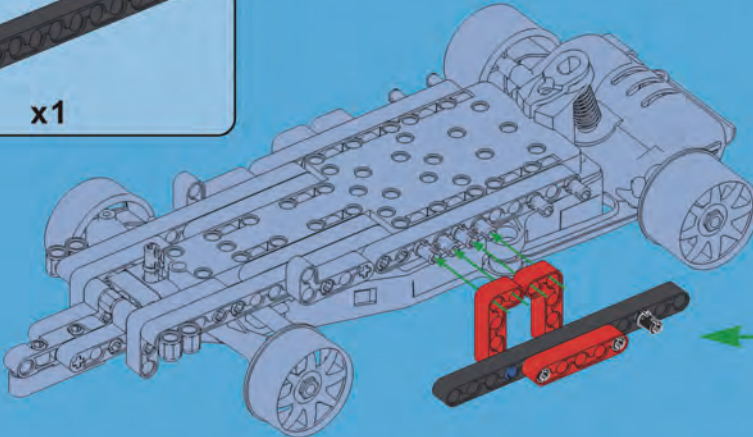

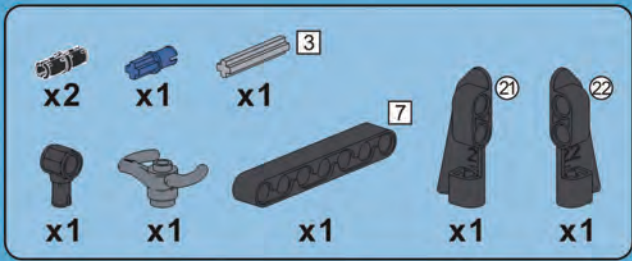

A12

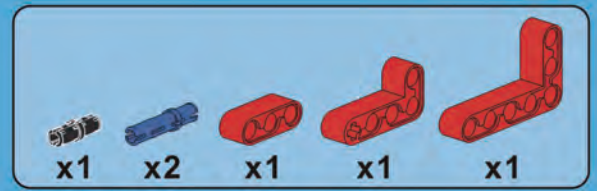
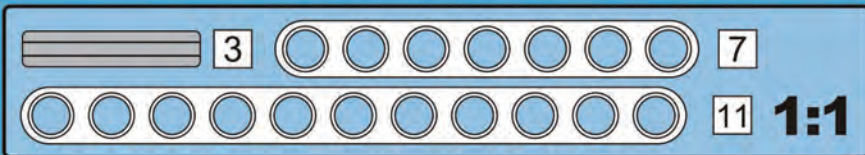
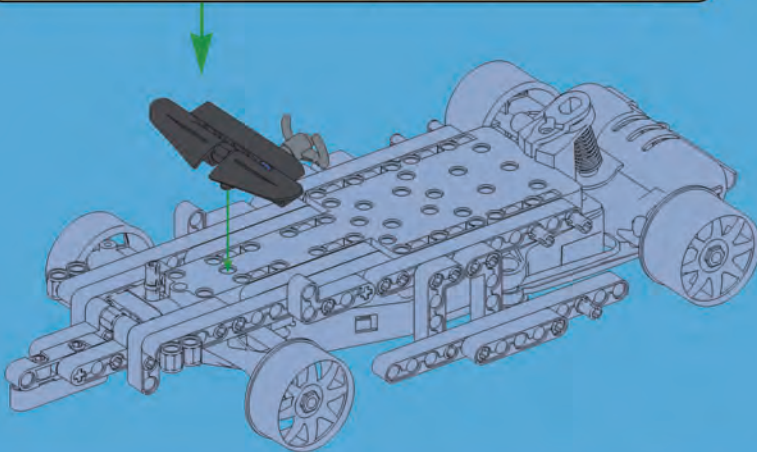
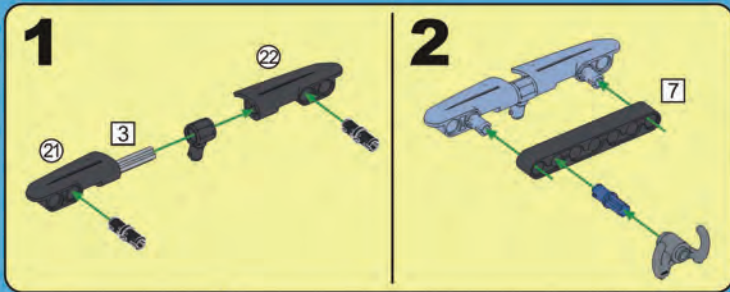

A13

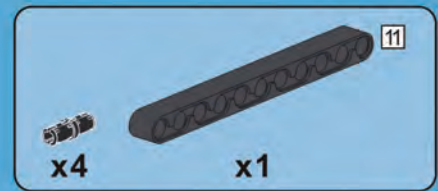
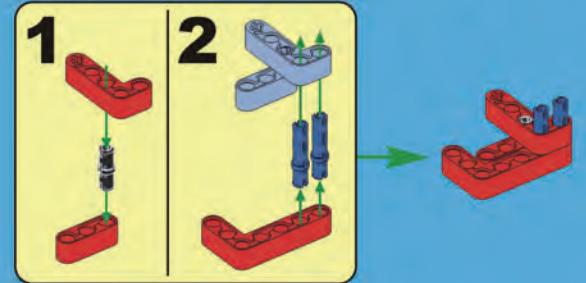

A14

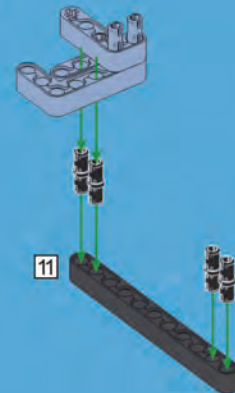

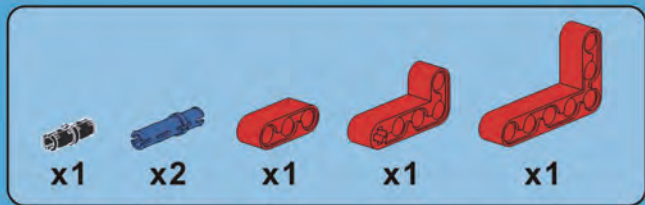

A15

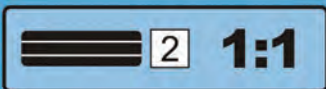
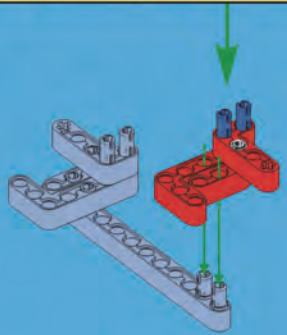
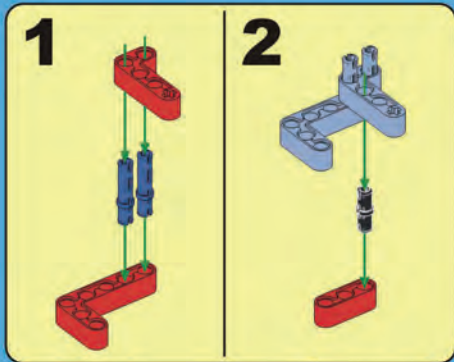

A16

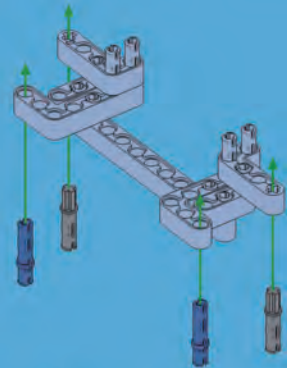

A17

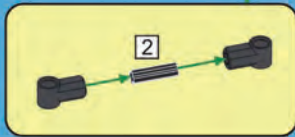
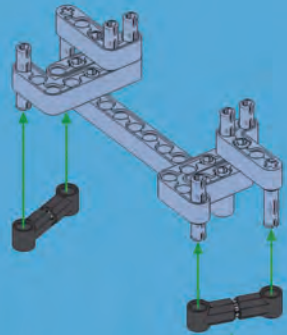

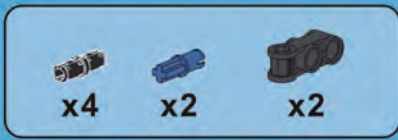

A18

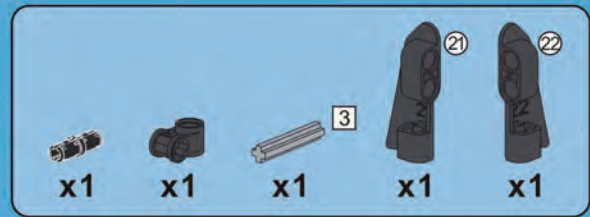
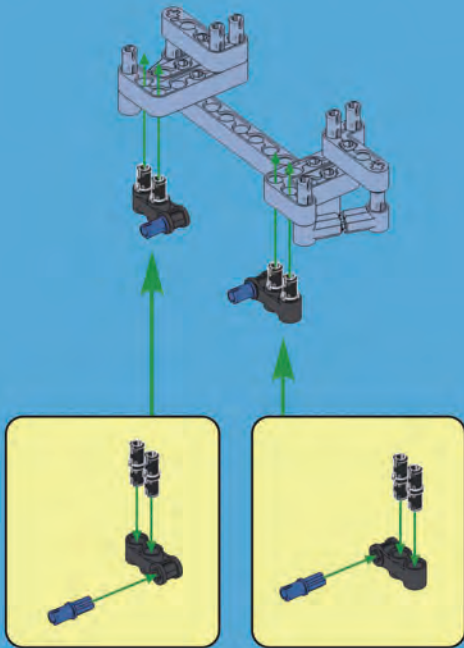

A19

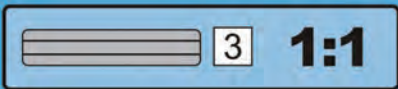
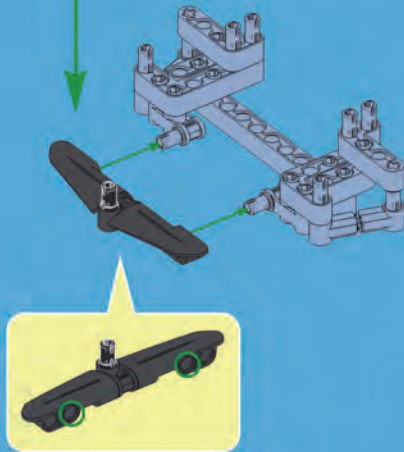
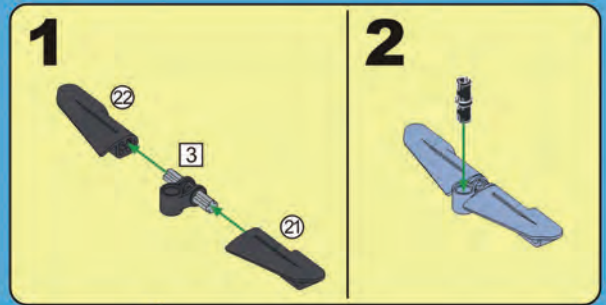



A20

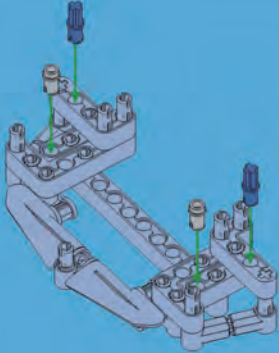

A21

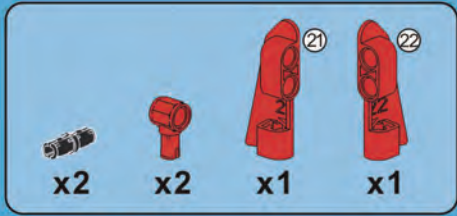
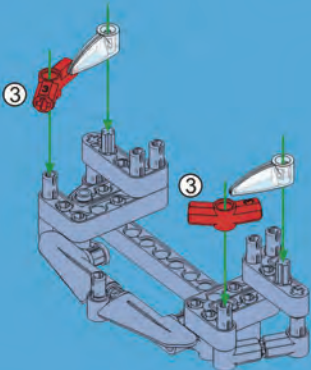

A22

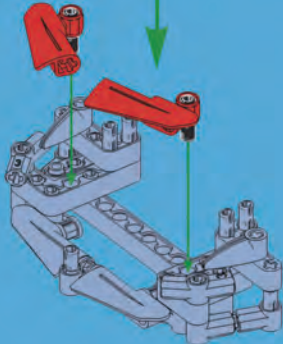
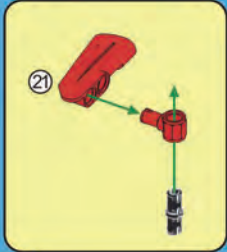
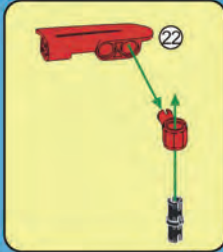

A23

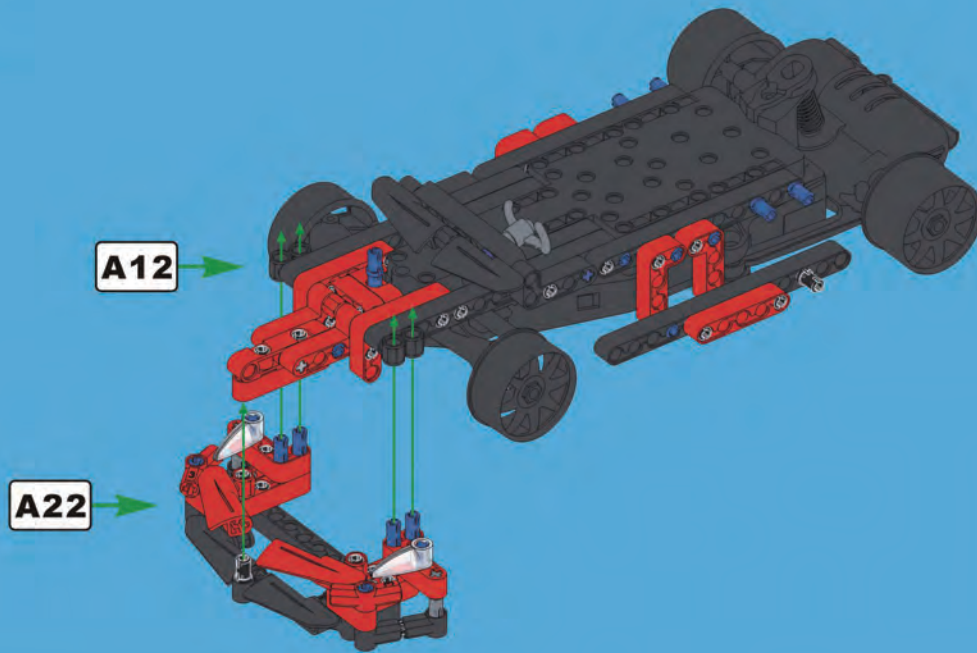

A24

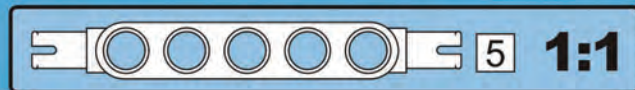
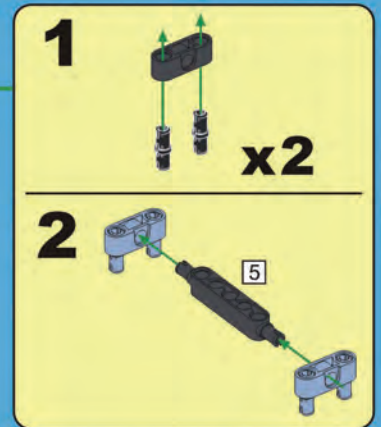
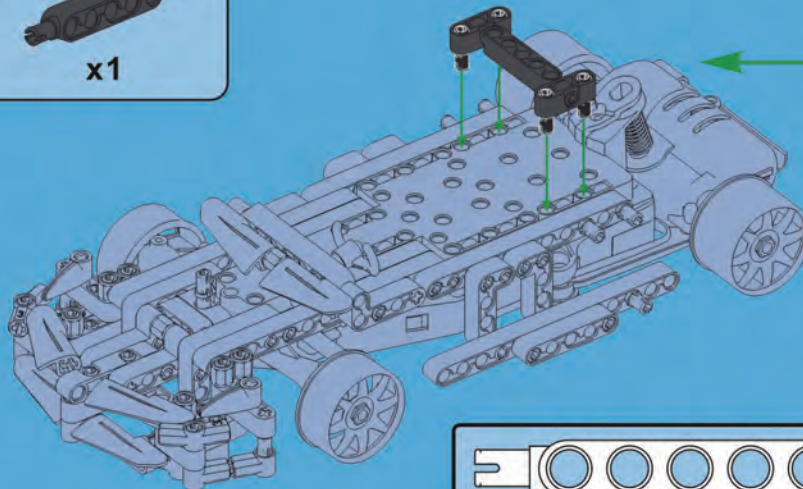

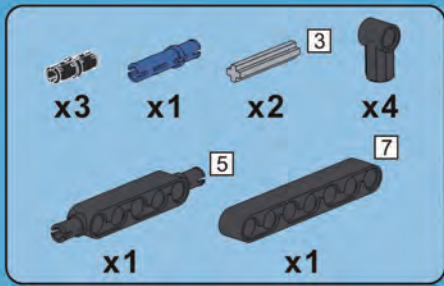

A25

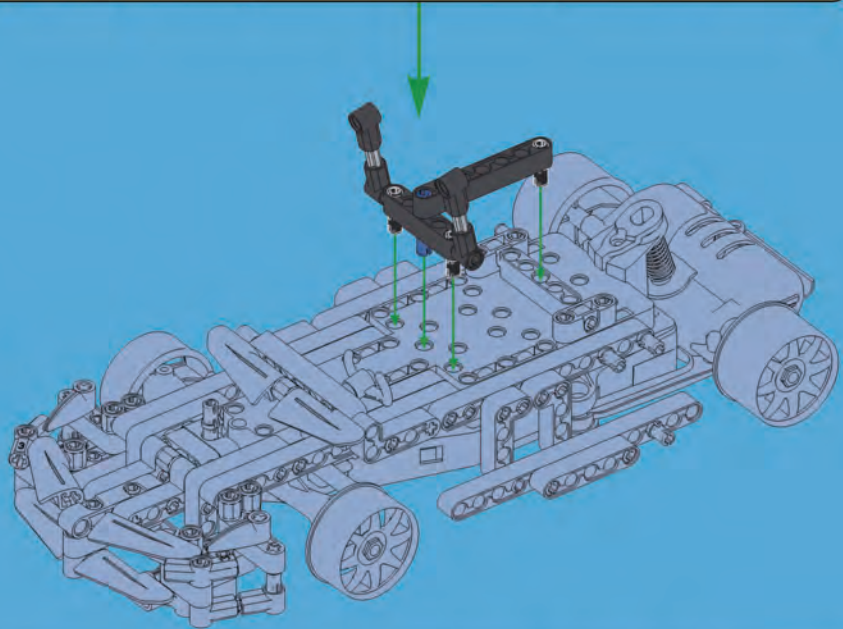
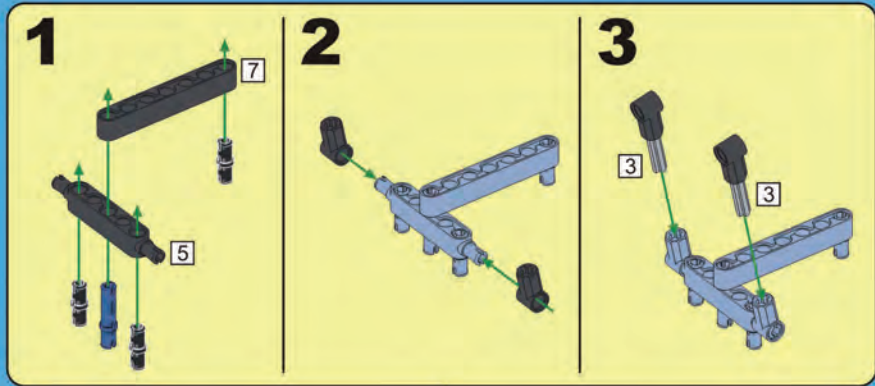



A26

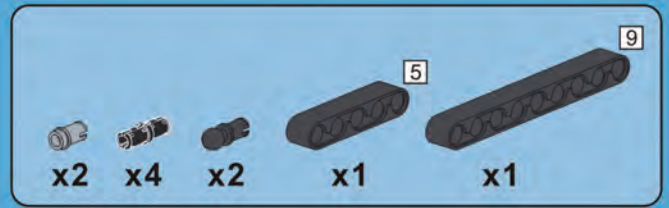
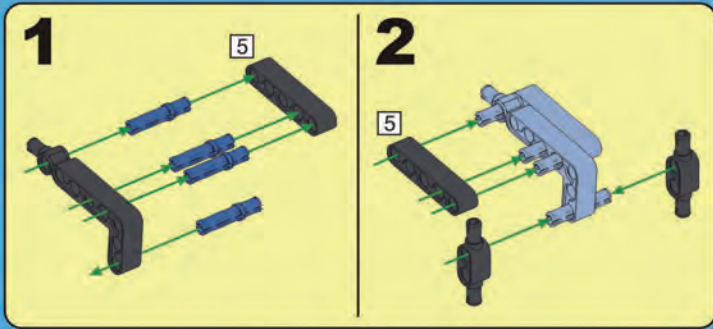

A27

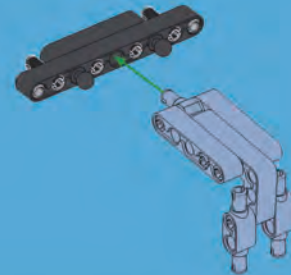
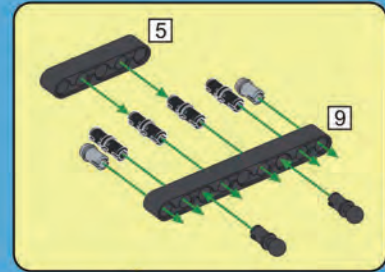

A28

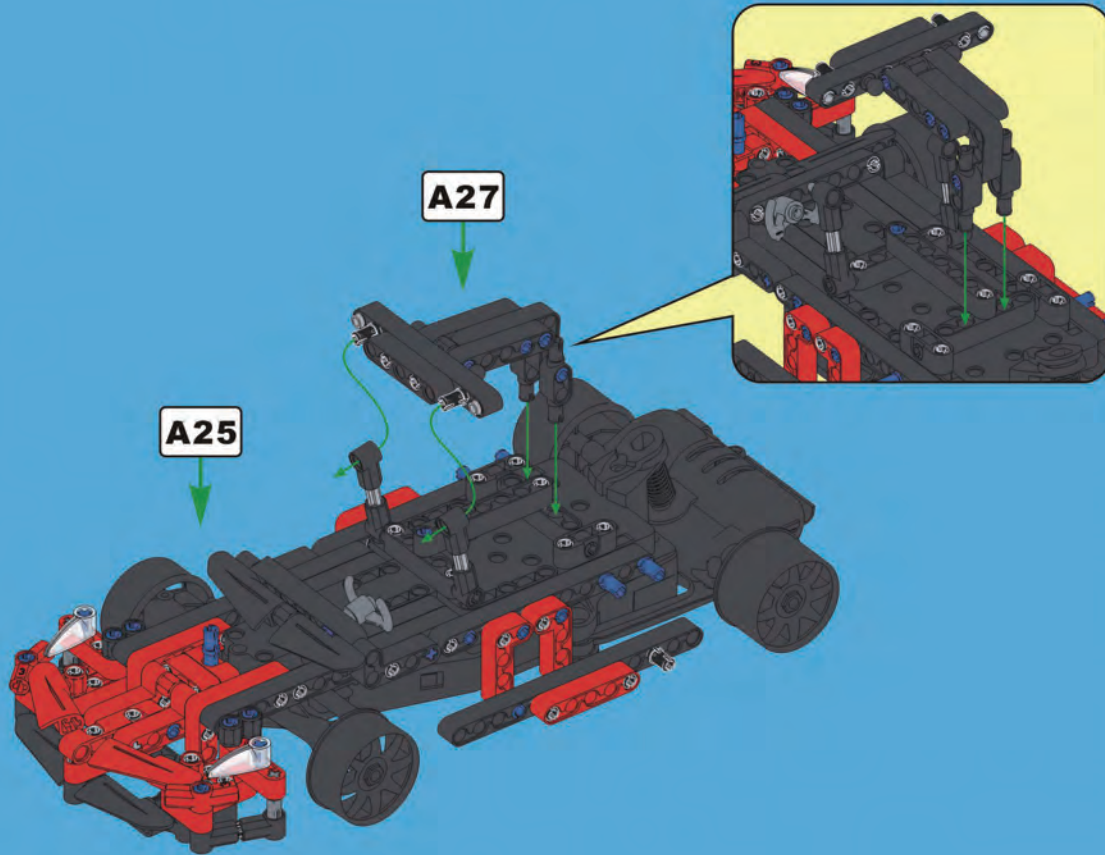

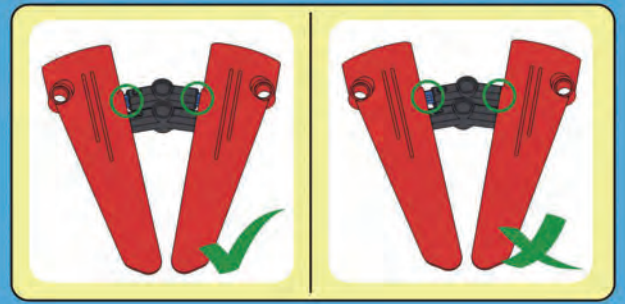
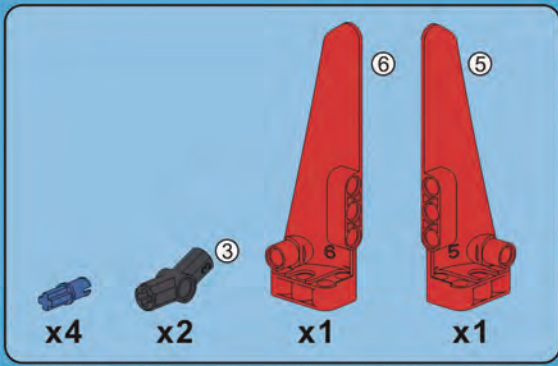

A29

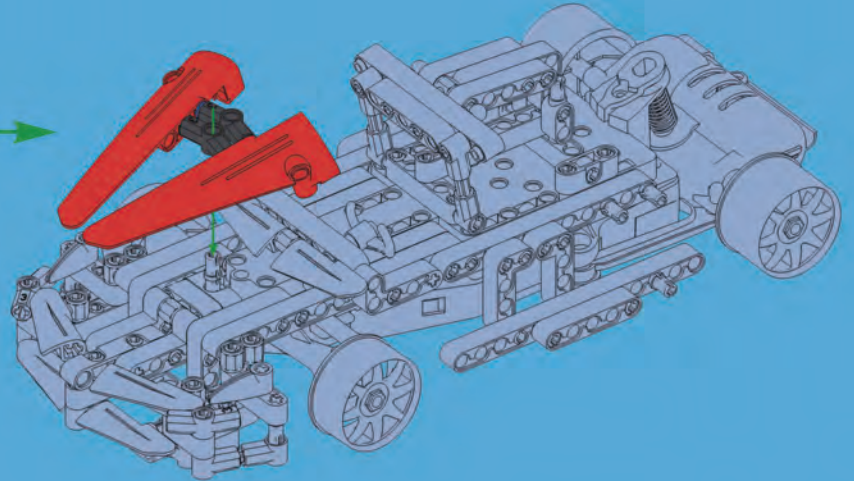
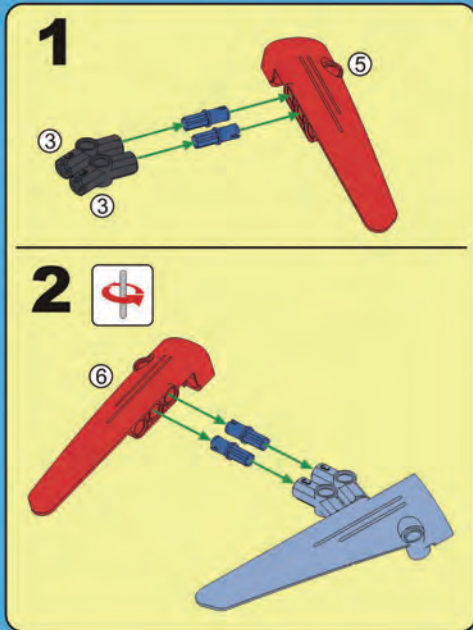



A30

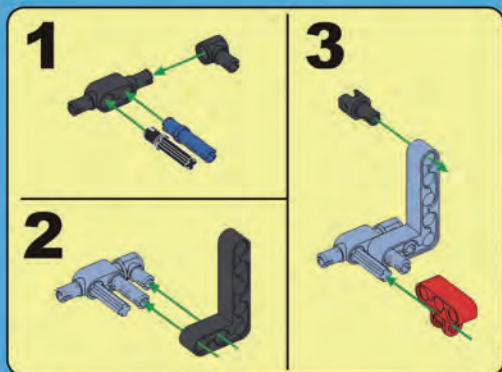

A31

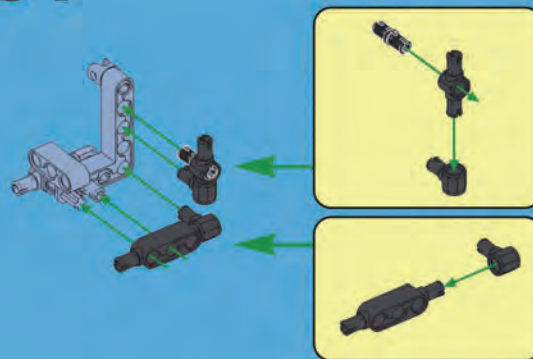

A32

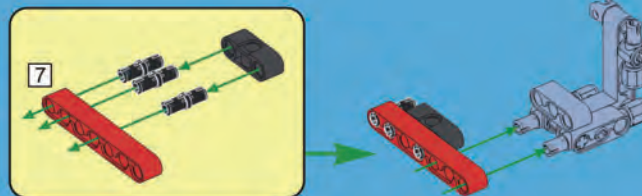



A33

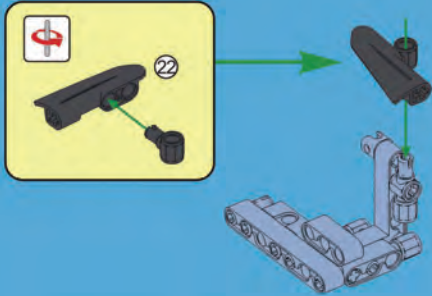

A34

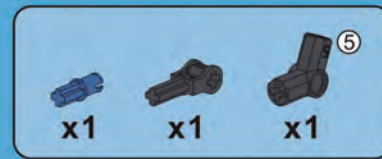

A35

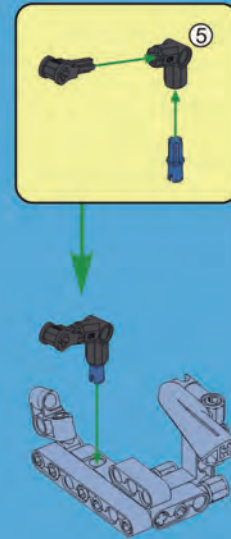

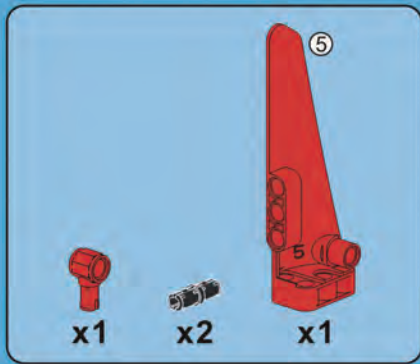

A36

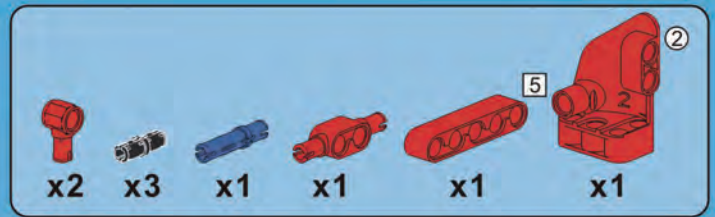
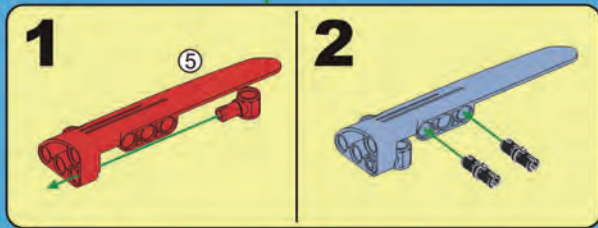
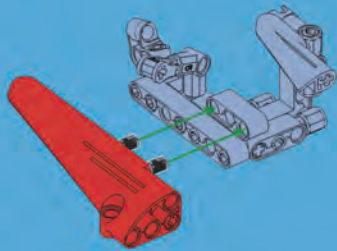

A37

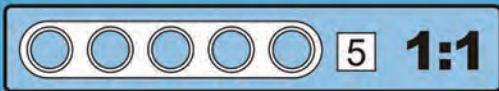
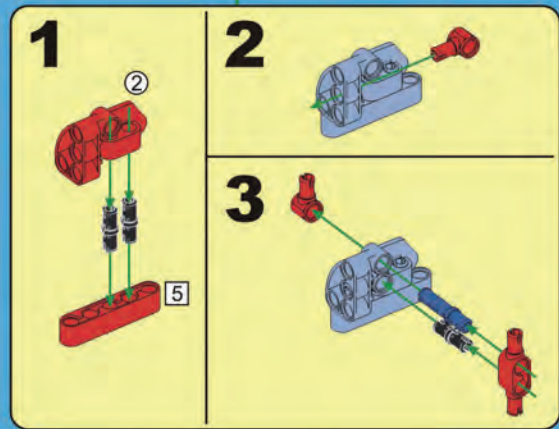
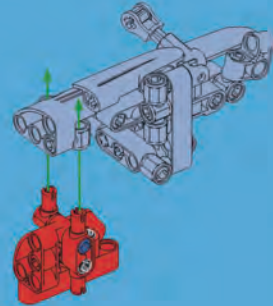

A38

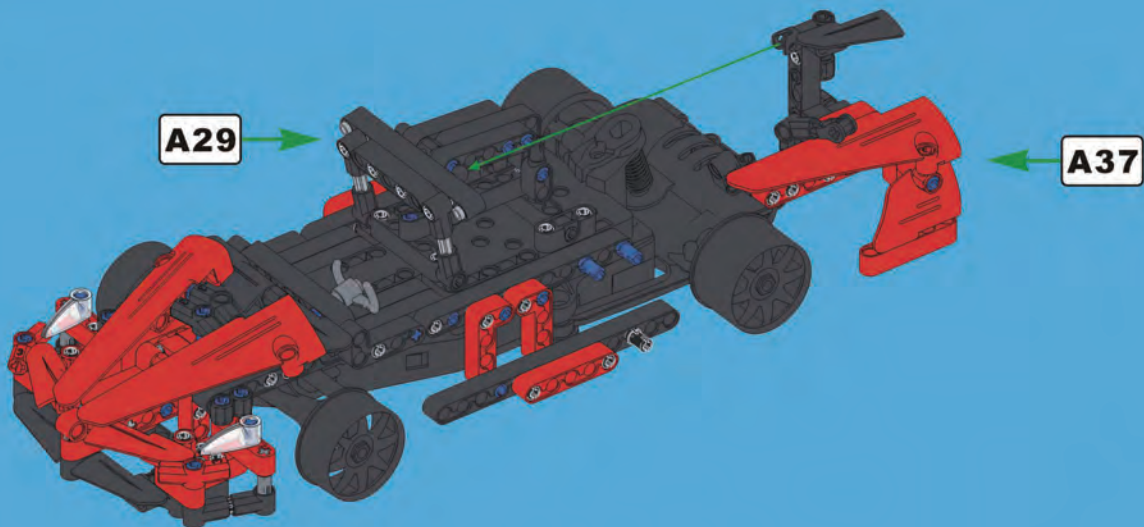

A29

A37



x1

x1

x1

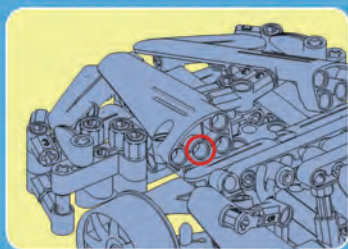

A39

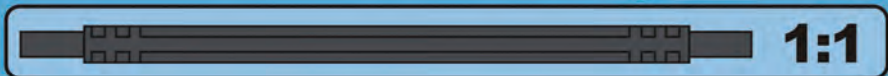
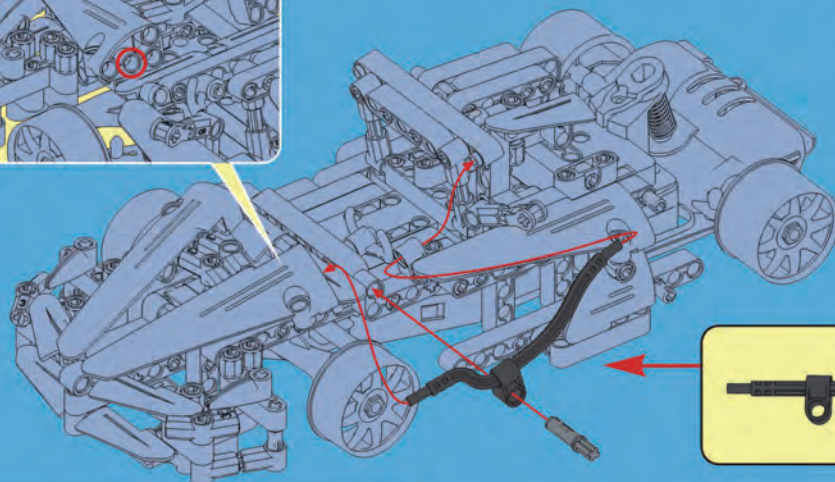

1:1

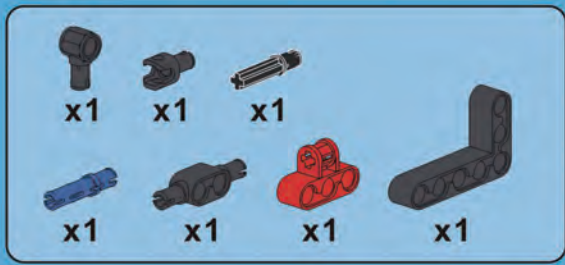

A40

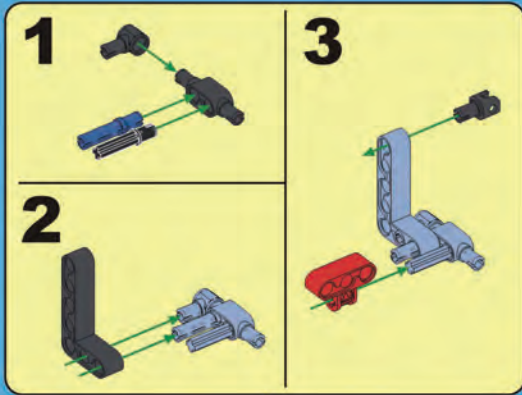

A41

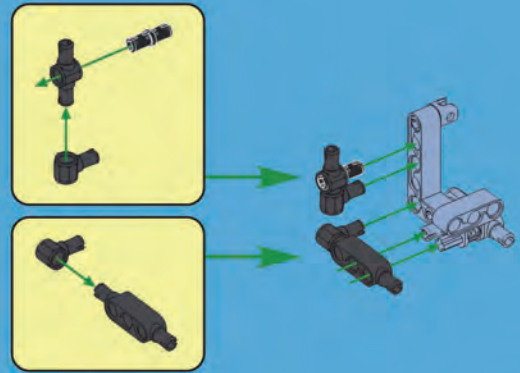



A42

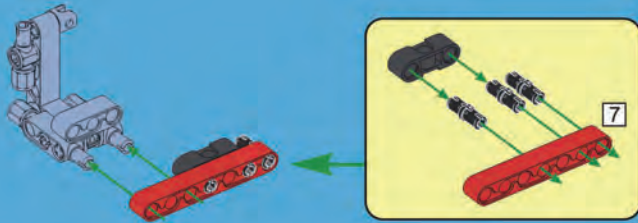

A43

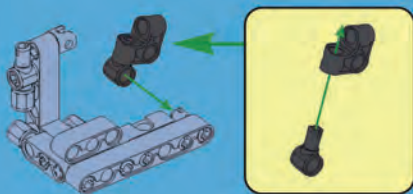

A44

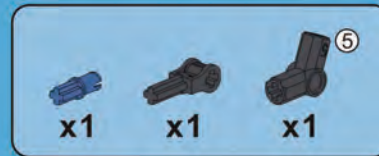
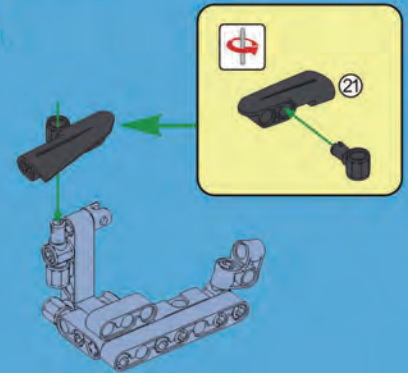

A45

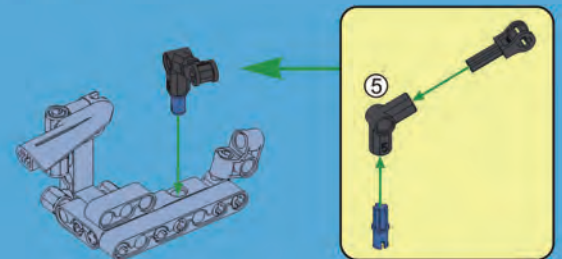

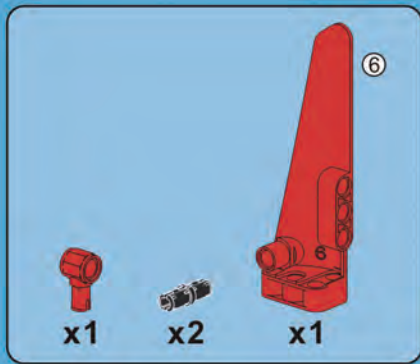

A46

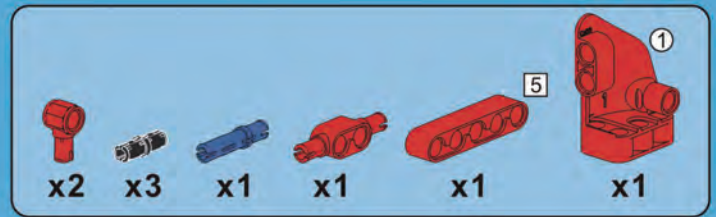
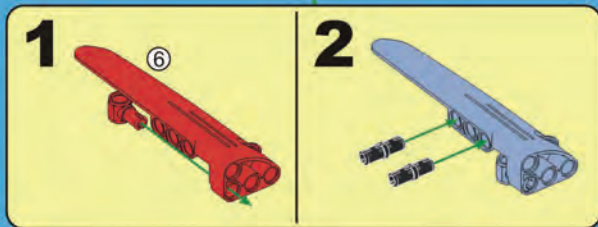
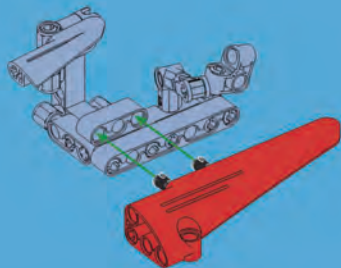

A47

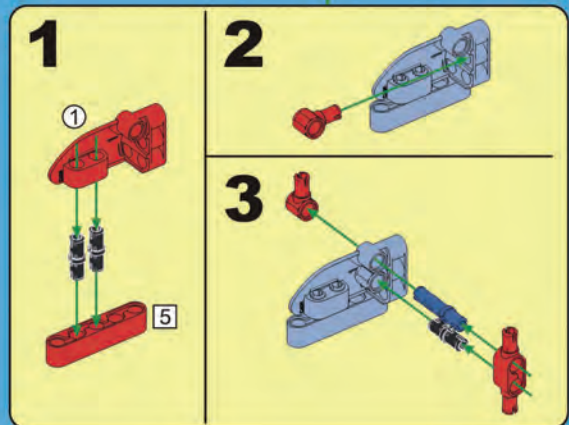
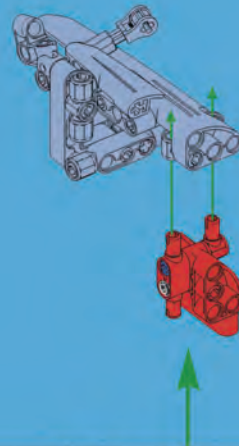

A48



A47

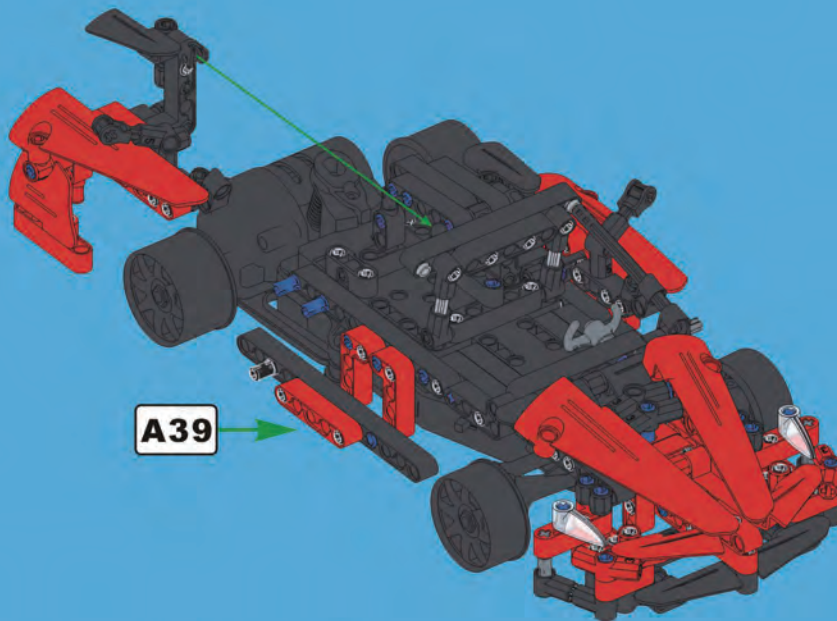

A39



A49

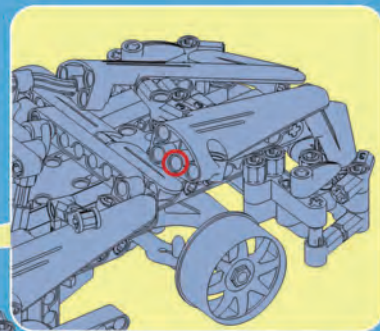
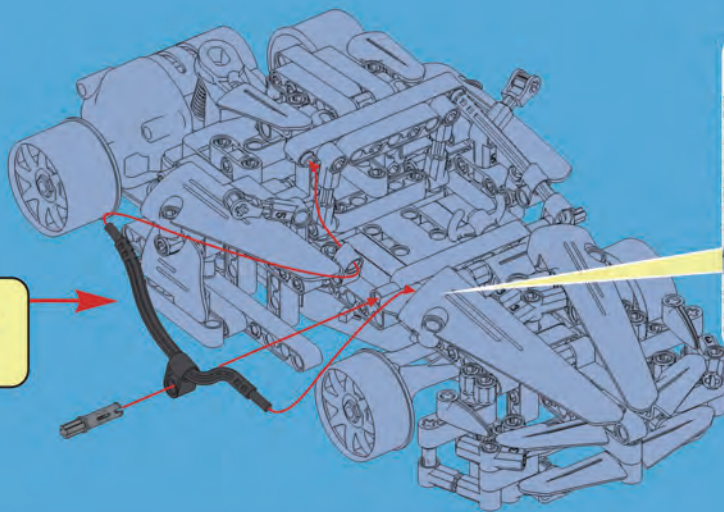
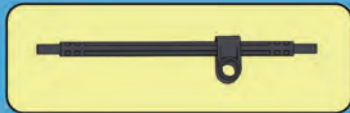

1:1



A50



A52

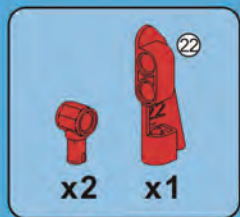
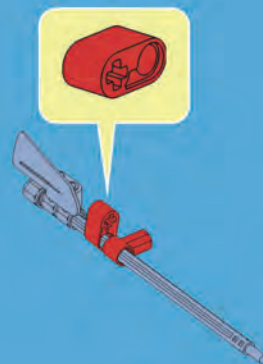

A51

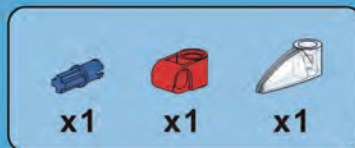
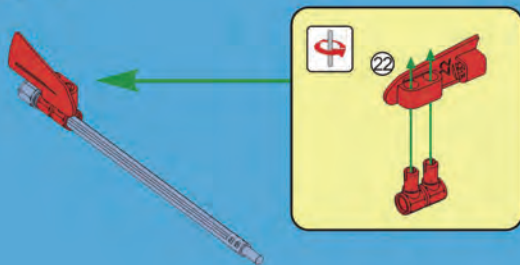

A53

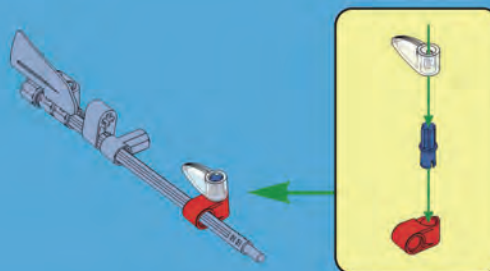

A54

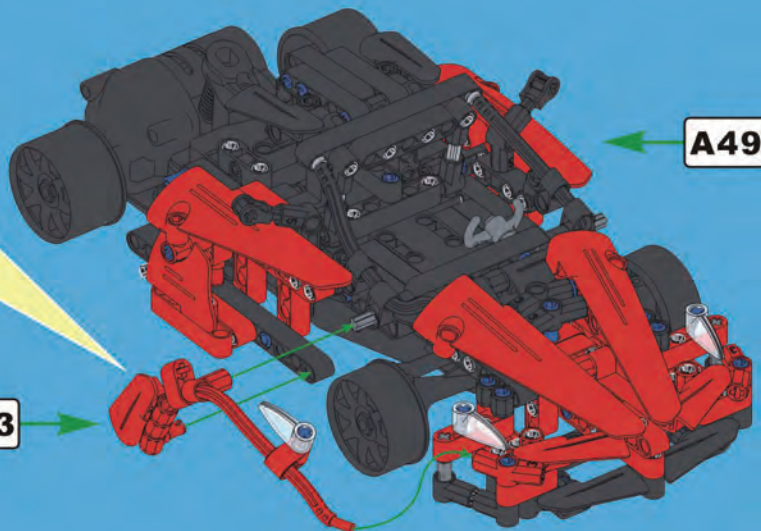
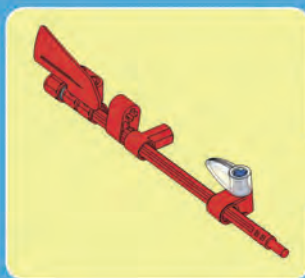

A53

A49



A55

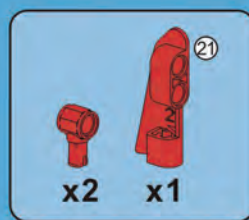
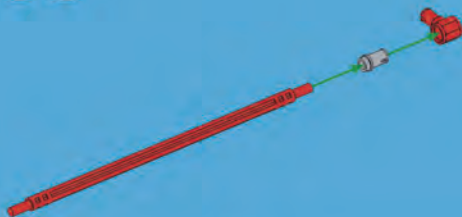

A56

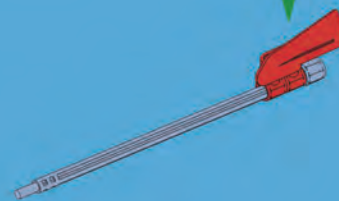
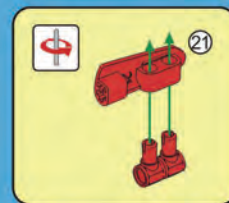

A59



A57

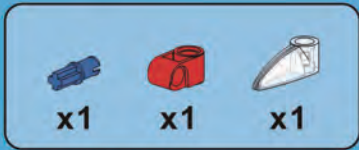
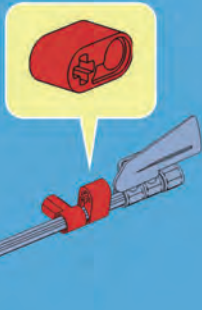

A58

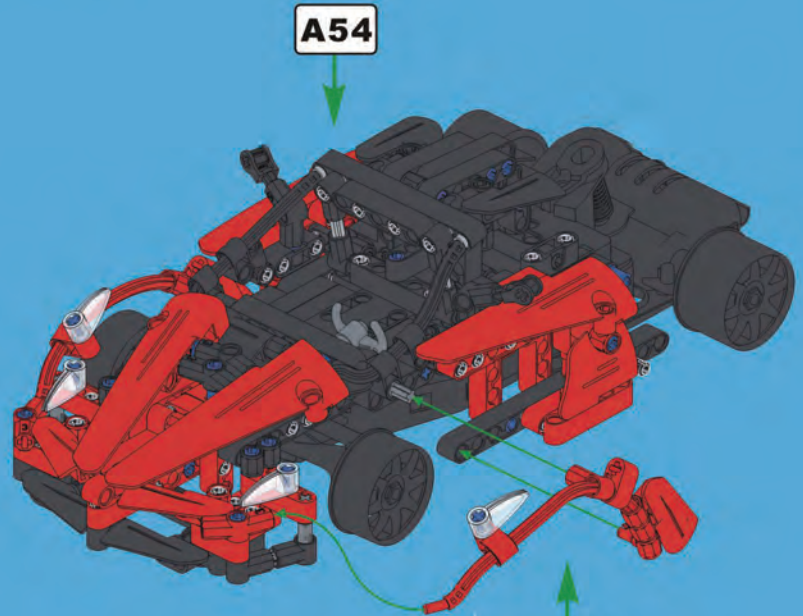
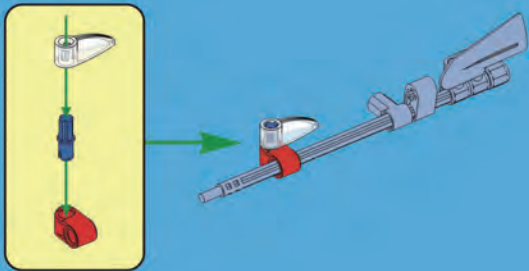

A54

A58

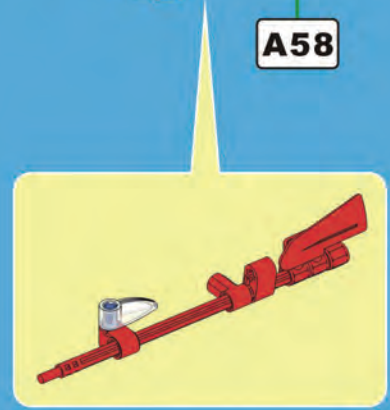

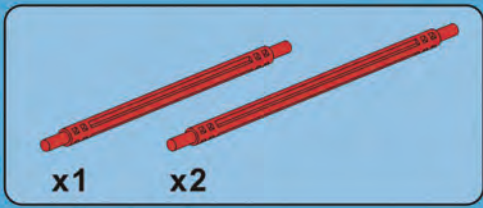

A60

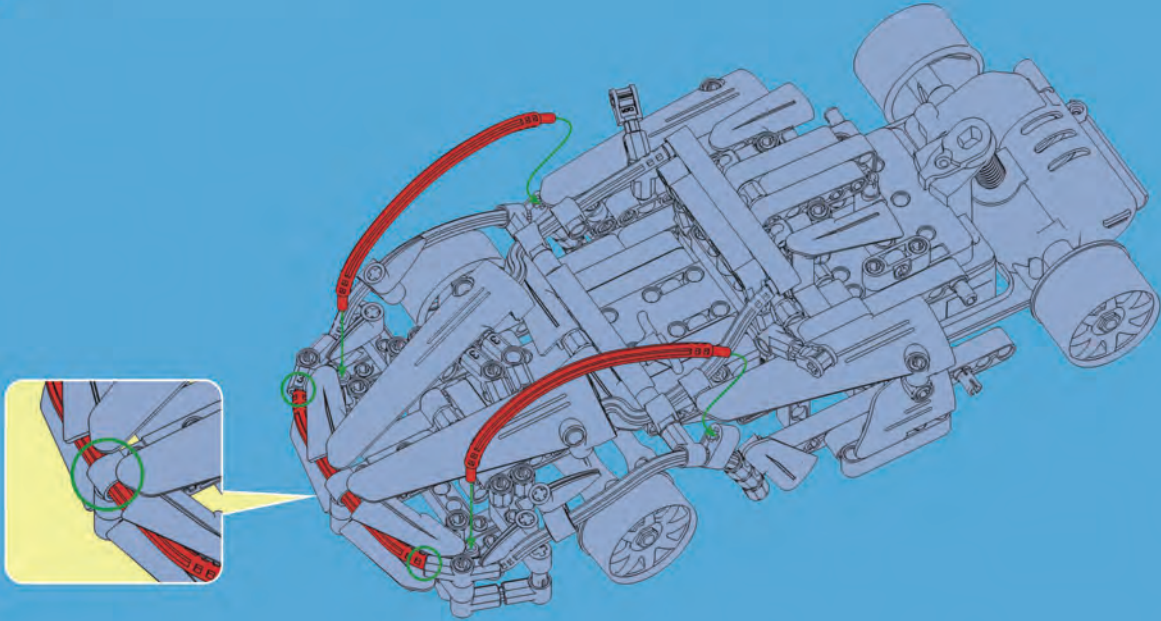

A64

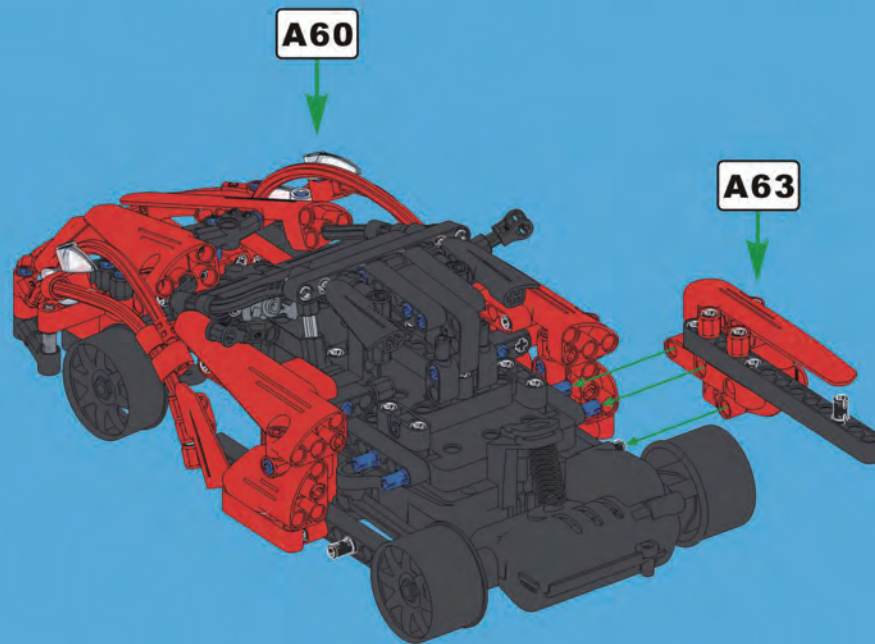

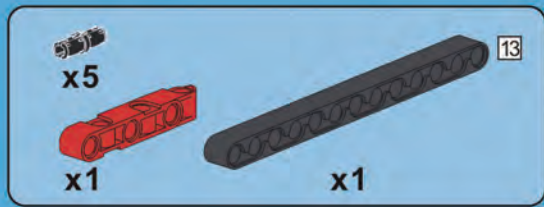

A65

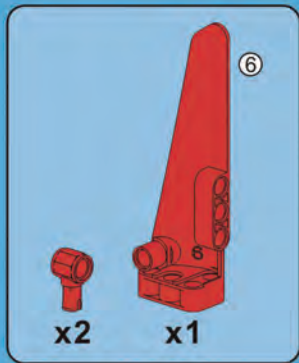
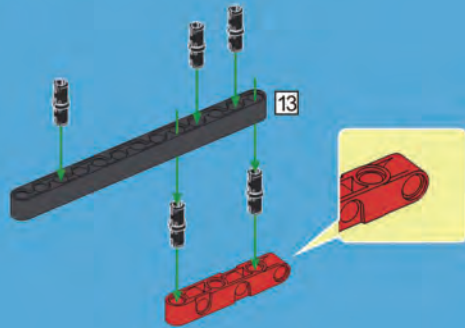

A66

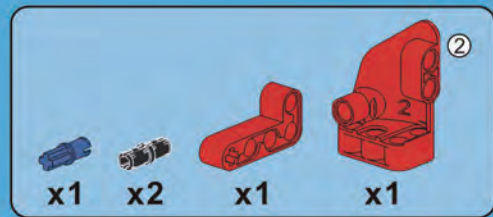
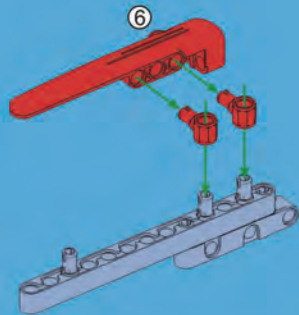

A67

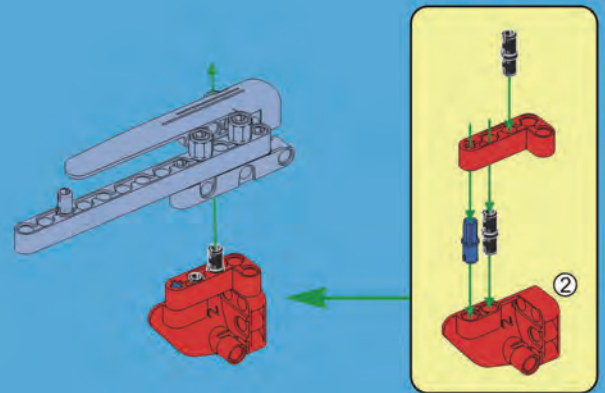

A68

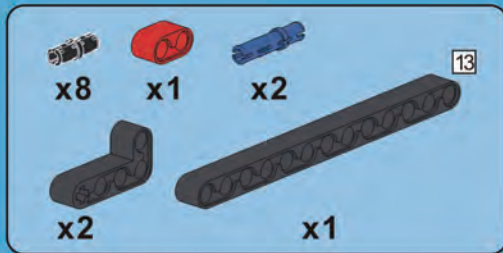
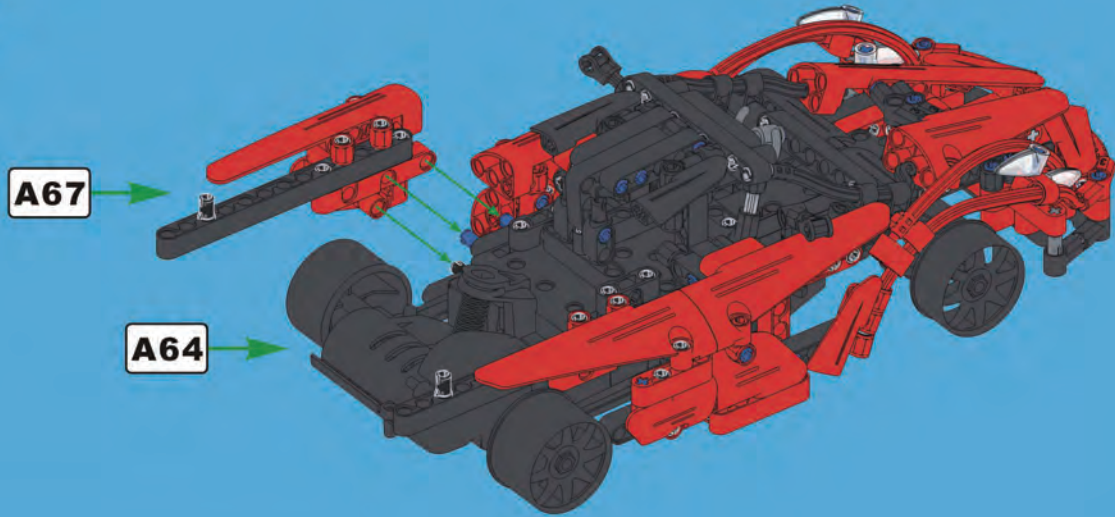

A69

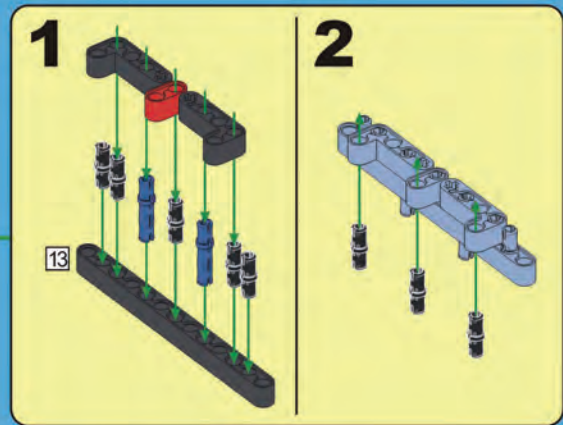
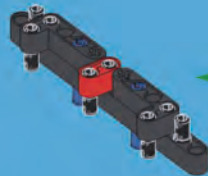

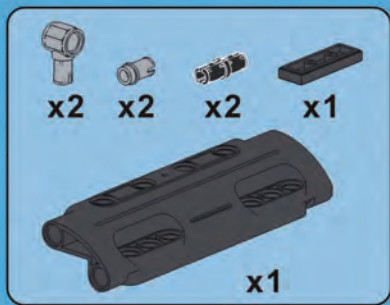

A70

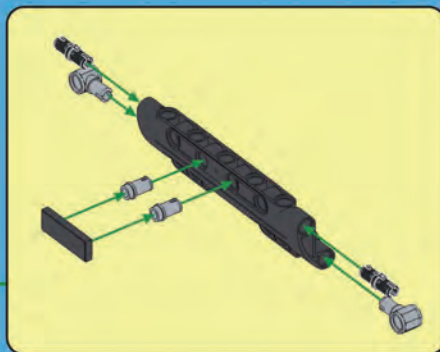
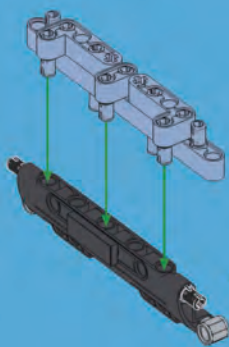

A71

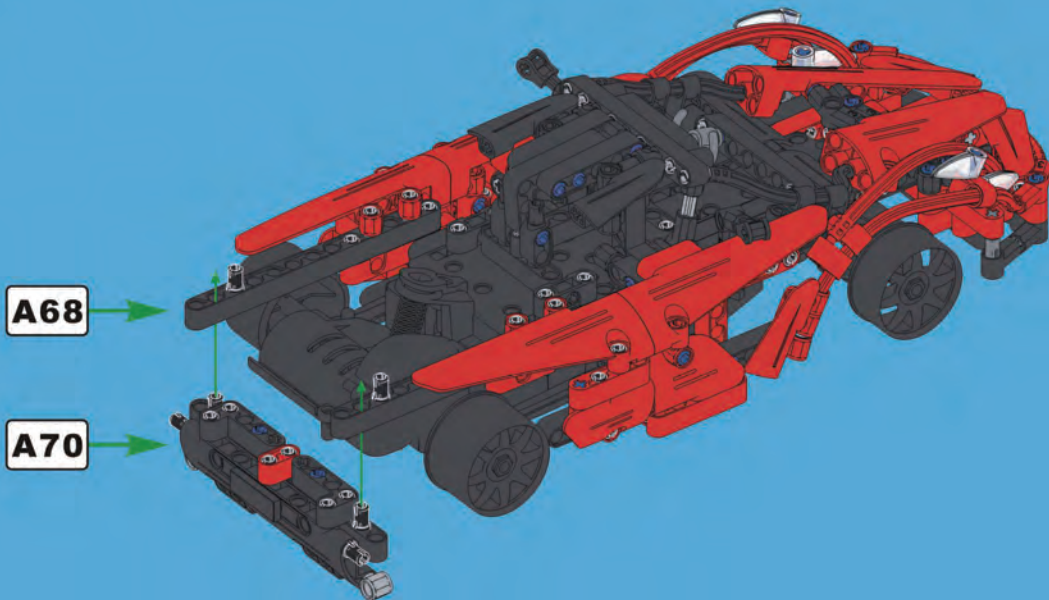

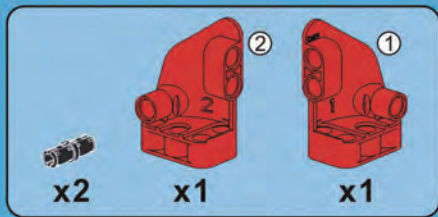

A72

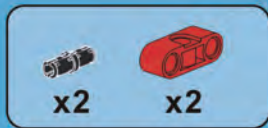
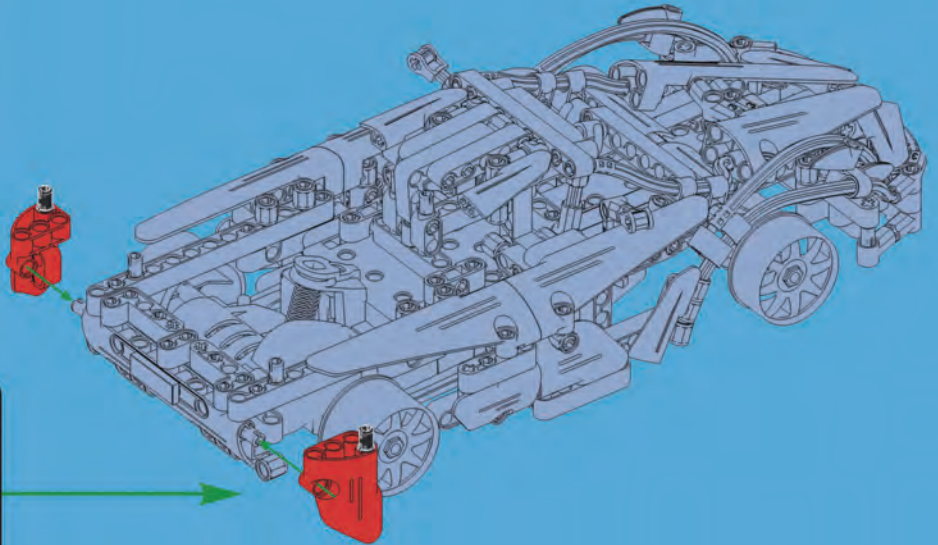
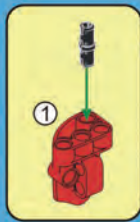

A73

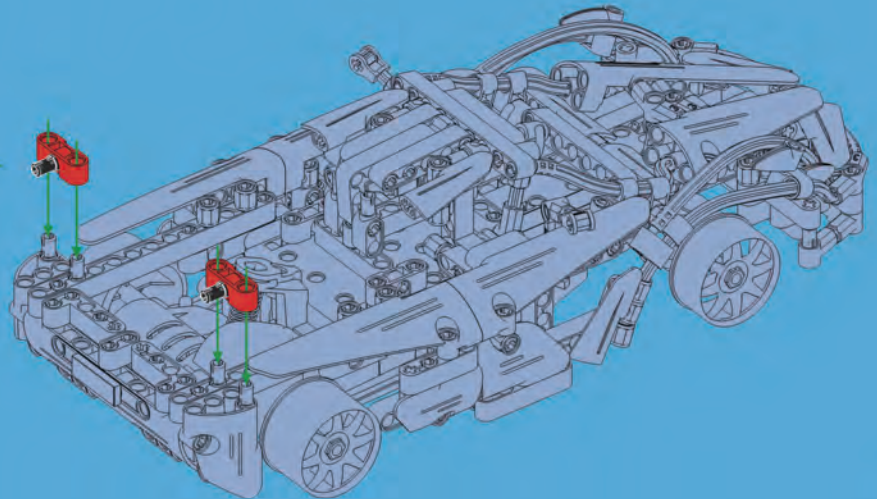
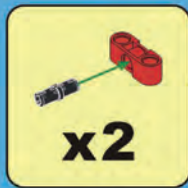

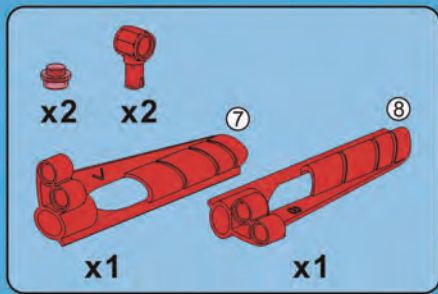

A74

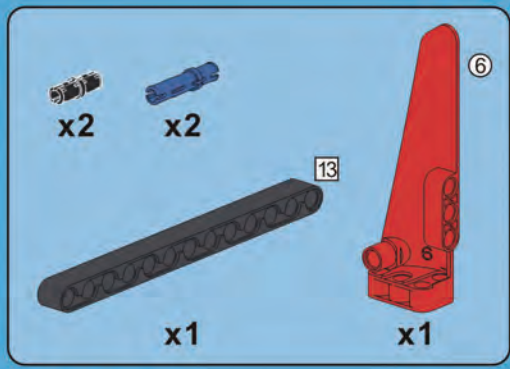
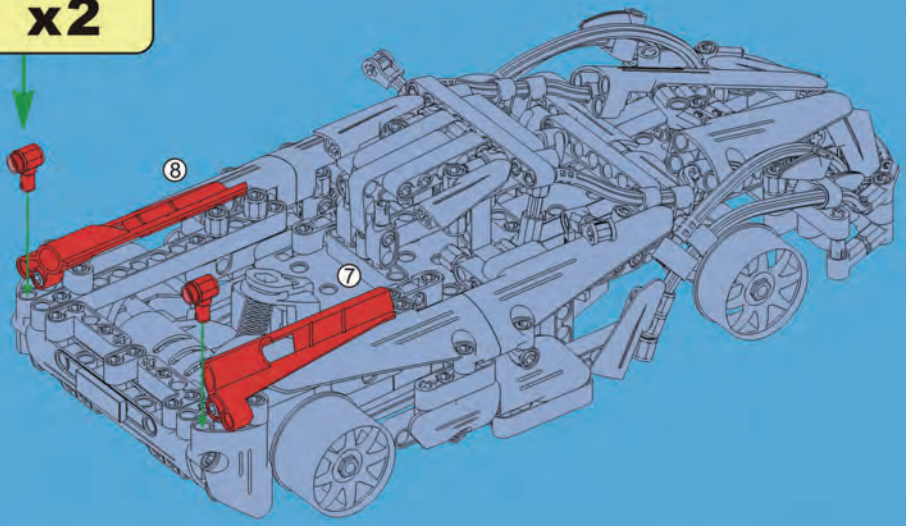

A75

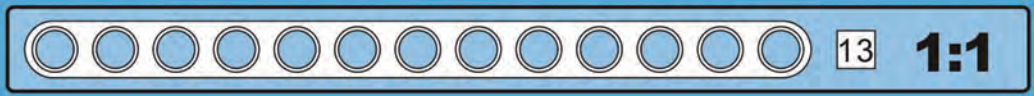
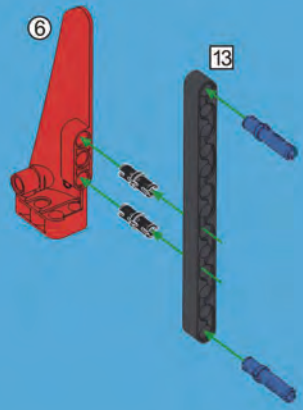

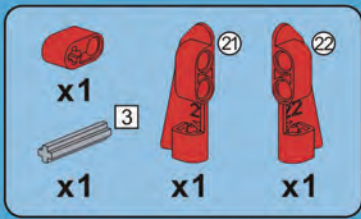

A76

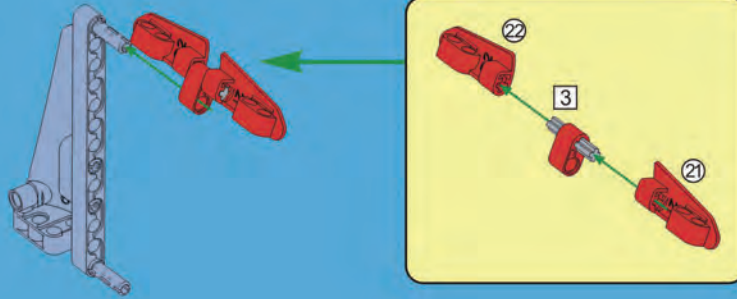

A77

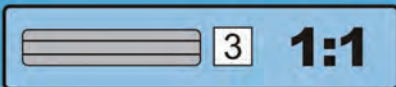
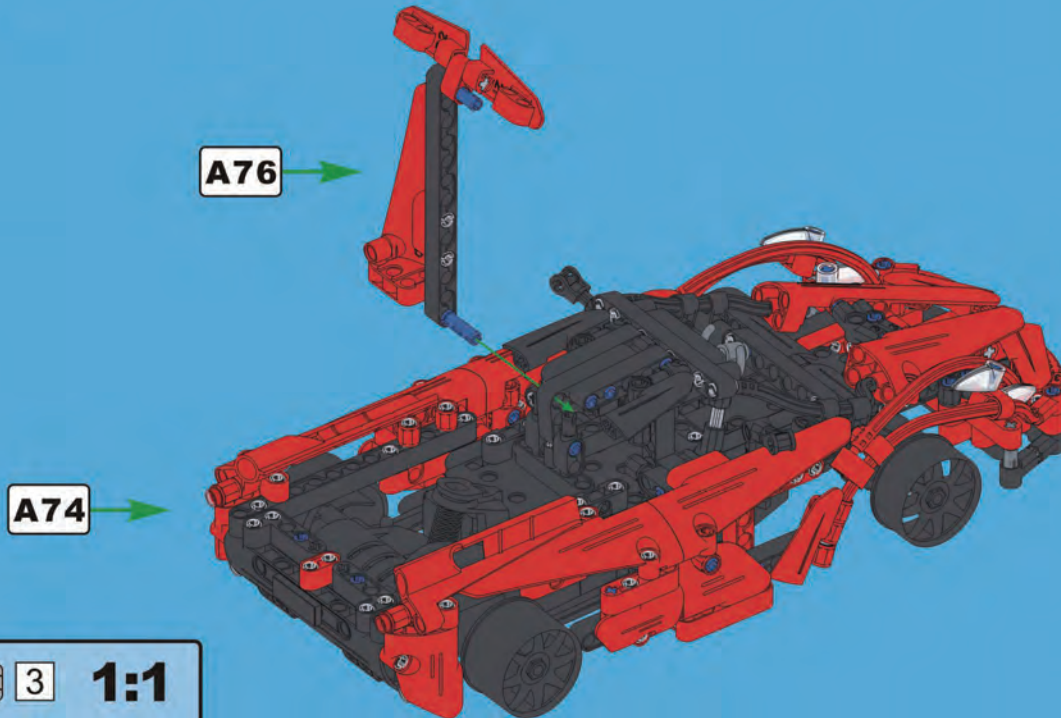

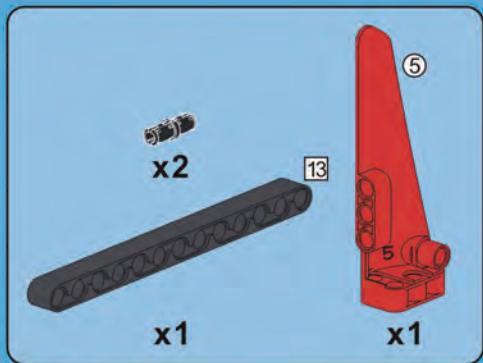

A78

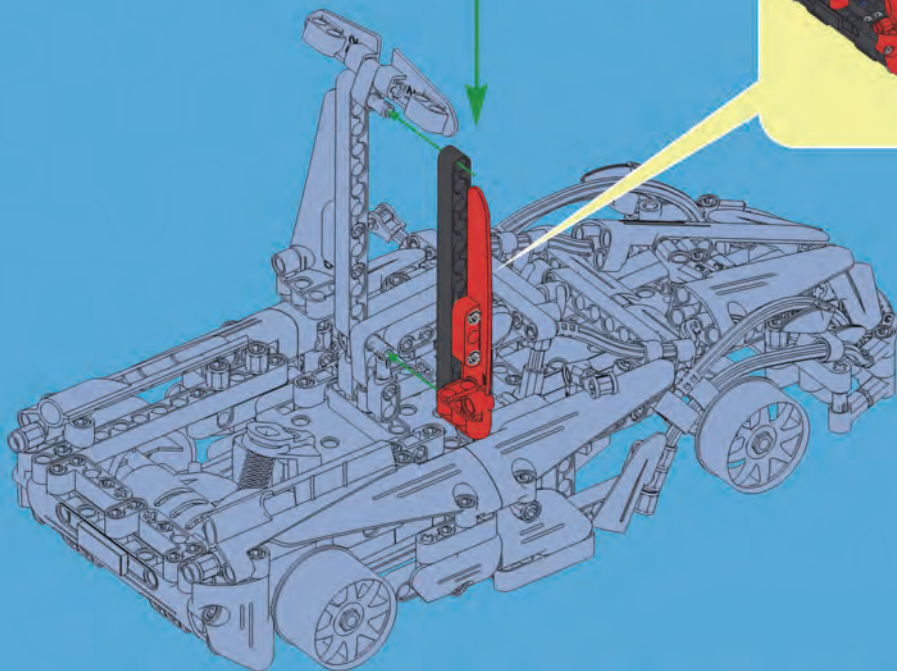
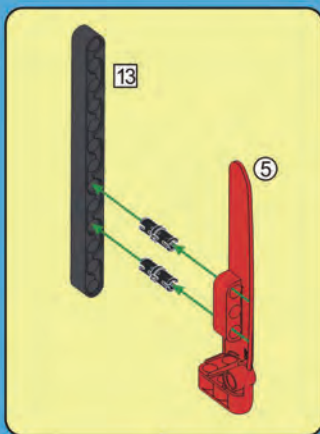

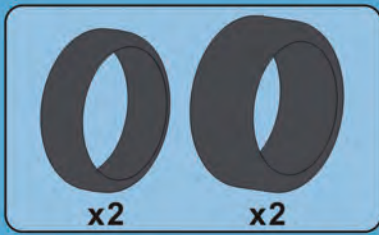

A79

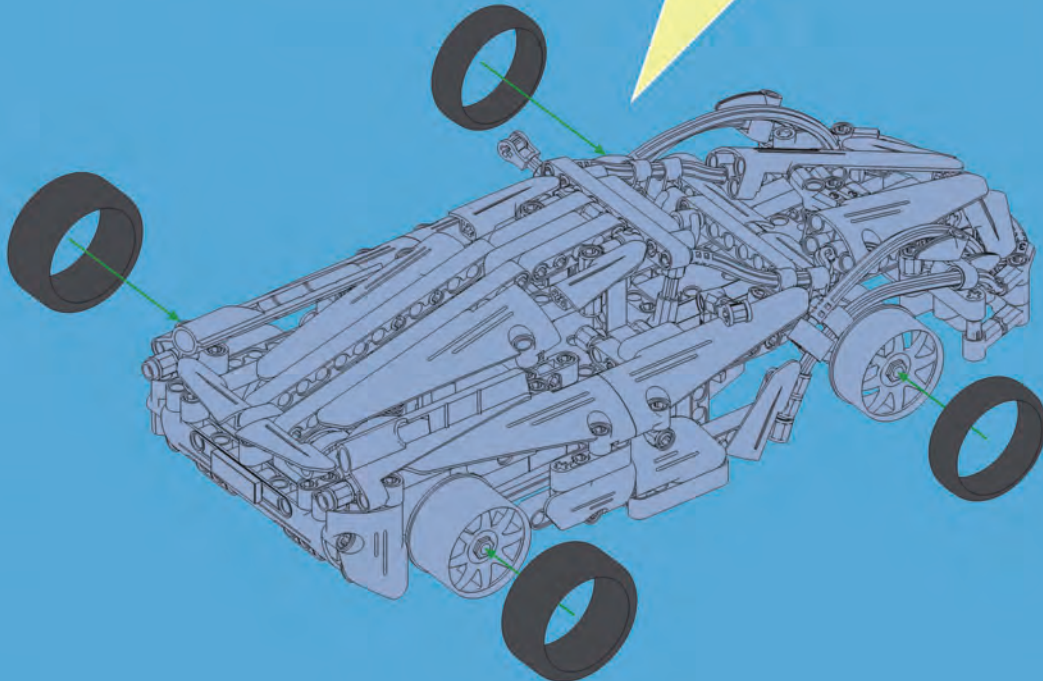
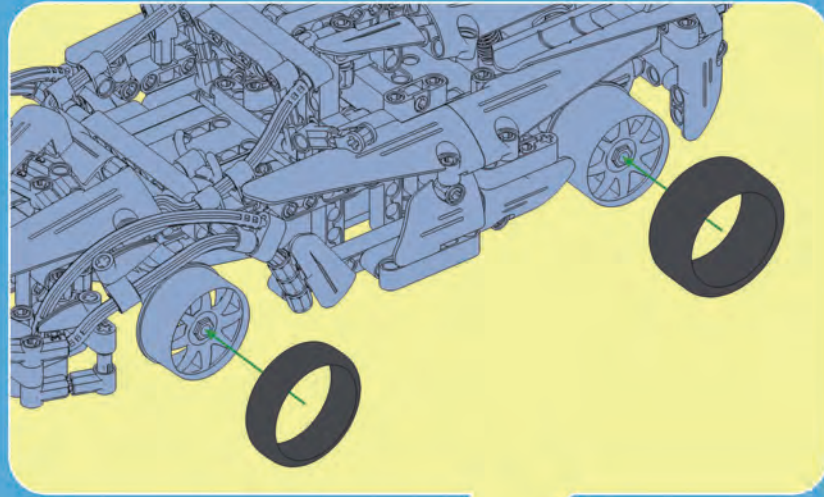

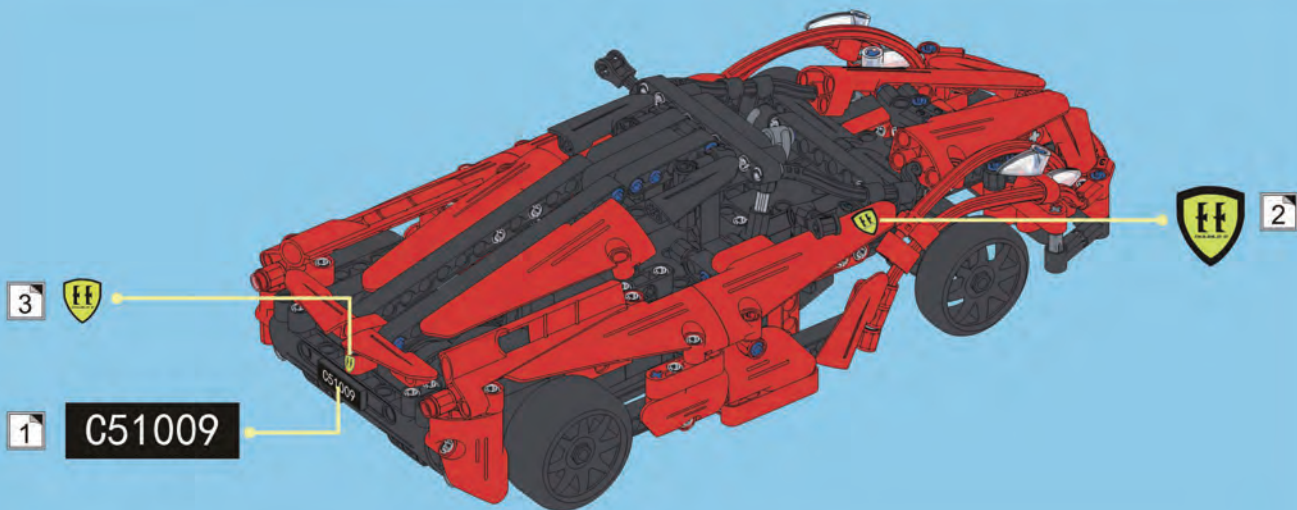
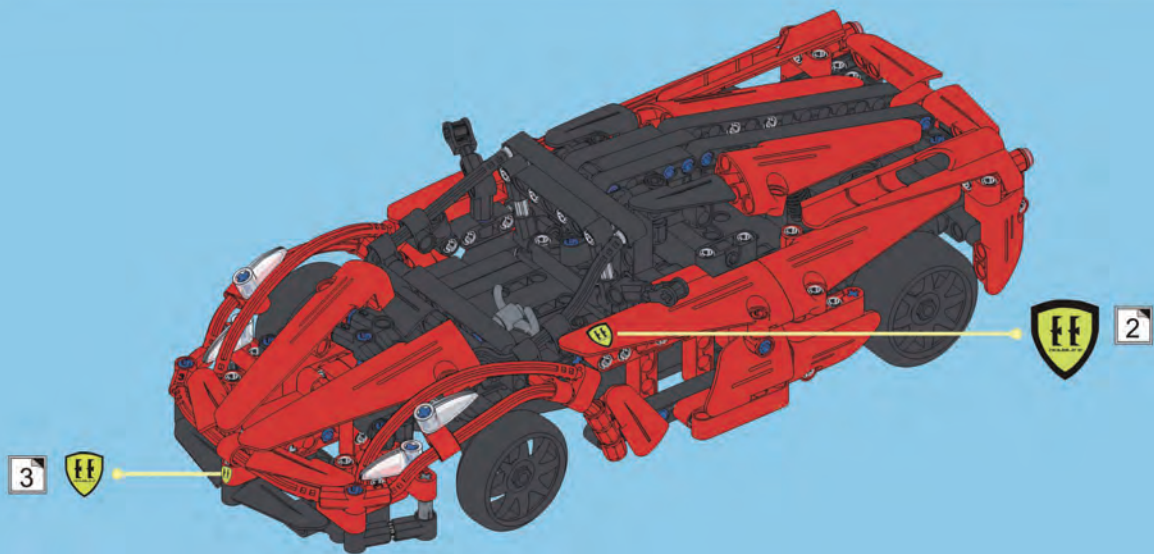

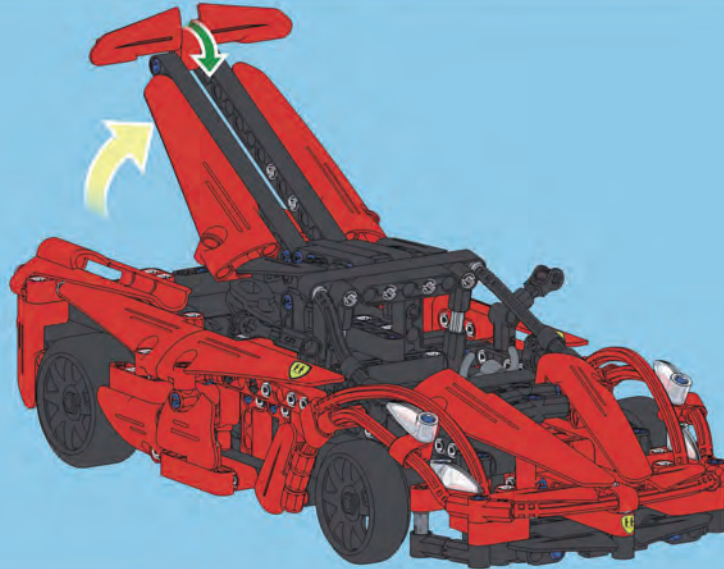
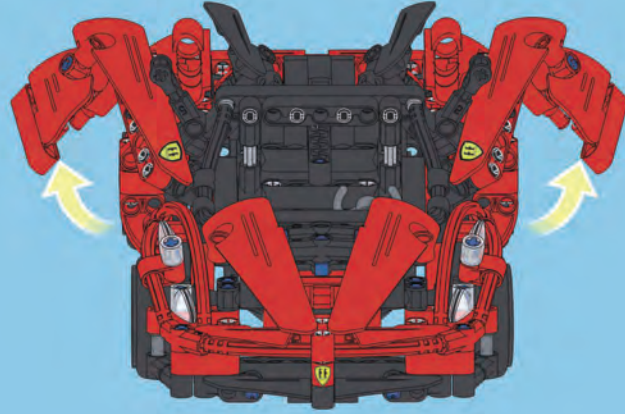

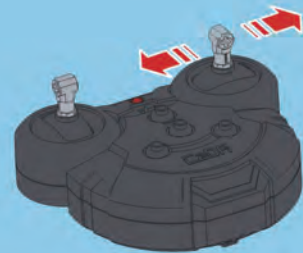
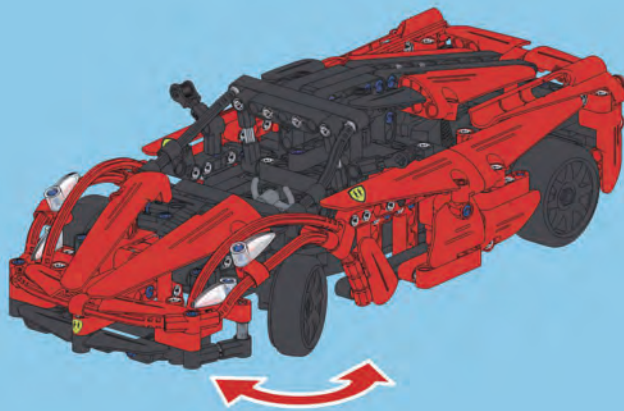
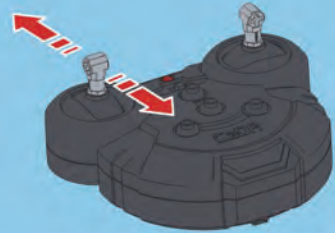
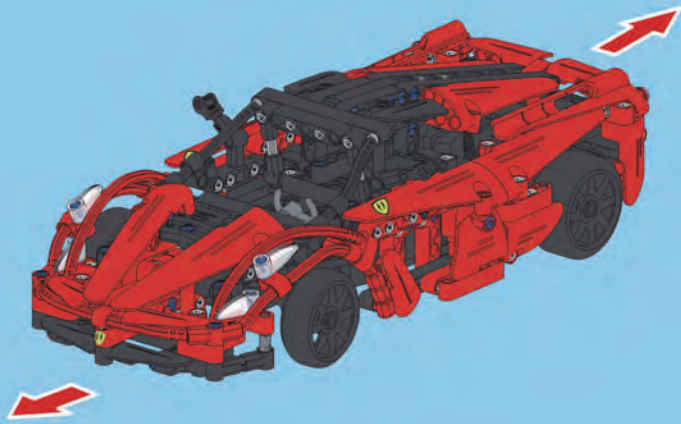

 x1 JA3030.02

 x2 JB1001.05

 x2 JF3044.01

 x2 JF4045.01

 x8 JH2015.01

 x102 JH2025.01

 x21 JH5001.01

 x33 JH2016.01

 x2 JH4022.01

 x2 JH4023.02

 x2 JH4058.01

 x2 JH4058.03

 x8 JH5026.01

 x2 JH5026.11

 x16 JH5032.01

 x2 JH5032.06

 x21 JH5032.07

 x1 JH5041.01

 x4 JH5044.01

 x2 JH5054.01

 x2 JH5064.01

 x2 JH6029.01

 x2 JH6031.01

 x2 JH6031.05

 x2 JH6037.10

 x2 JH6039.01







 x2 JH6048.03







 x4 JX4042.11



 x1 JX1044.01







 x4 JH0011.01

 x6 JH0013.01



 5
 x1 JH0004.01

 x3 JJ6018.05

 x3 JJ6031.01

 x4 JJ6031.02

 x1 JJ6032.01

 x4 JJ6034.01

 x2 JJ6034.02













 x2 JJ6035.04

 x1 JJ6035.01 5

 x2 JJ6036.03

 x2 JJ6040.03

 x4 JJ7011.02

 x10 JJ7011.01

 x3 JJ7012.02

 x4 JJ7012.01

 x1 JJ6003.01

 x2 JJ6004.02 5

 x3 JJ6005.01 5

 x5 JJ6005.03 7

 x4 JJ6006.01 7

 x2 JJ6006.02 9

 x1 JJ6007.01 11

 x3 JJ6008.02 13

 x9 JJ6009.02

 x2 JR3009.04

 x2 JR3011.02

 x1 JR3012.02

 x2 JR3012.01

 21
 x3 JX4035.14
 21
 x3 JX4035.08
 2
 x3 JX4045.20
 6
 x4 JX4034.06
 2
 x2 JT2002.01
 7
 x1 JX4036.07
 8
 x1 JX4036.08
 21
 x3 JX4035.13
 22
 x3 JX4035.07
 1
 x3 JX4045.19
 5
 x4 JX4034.05
 2
 x2 JT2003.01

