

# FILTRA PRO

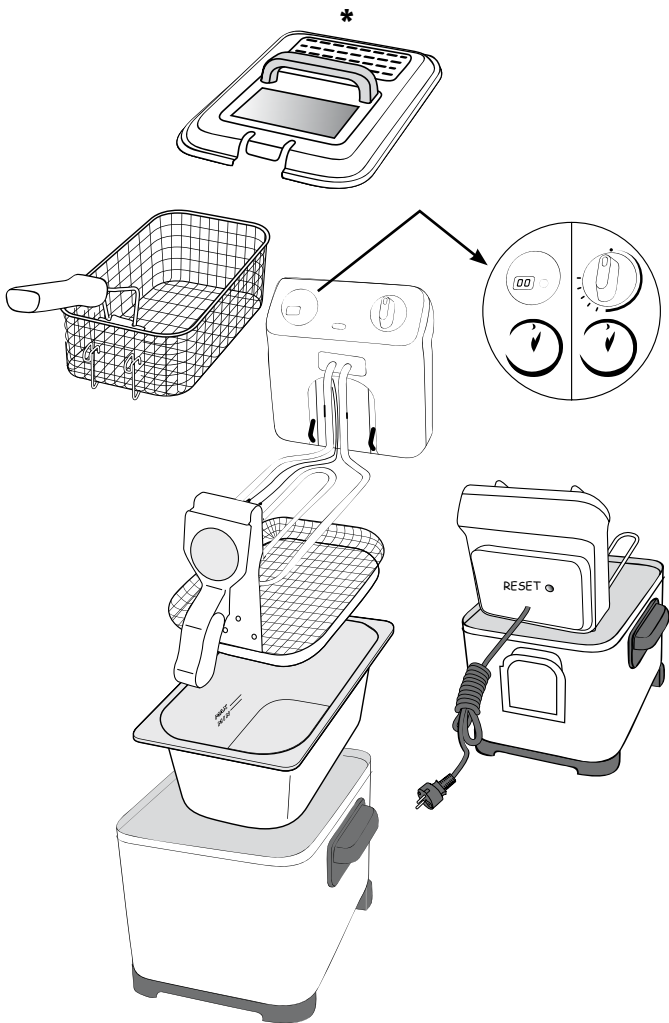



- \* Selon modèle - Afhankelijk van de model - Je nach Modell - Depending on model - Secondo il modello - Según modelo - Consoante o modelo - Ανάλογα με το μοντέλο - Modele göre - Afhængigt af modellen - Beroende på modell - Avhengig av modell - Mallista riippuen - Ovisno o modelu - U zavisnosti od modela - Modelltöl fuggöen - Според модела - Odvisno od modela - Zależnie od modelu - Podle typu - Podľa typu - Bizonyos típusoknál - В зависимости от модели - Залежно від моделі - În funcție de model - Vastavalt mudelitele - Atbilstoši paraugiem - Pagal modelius - بر حسب الموديل - بر حسب مدل



1

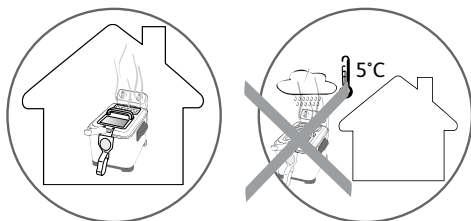

2

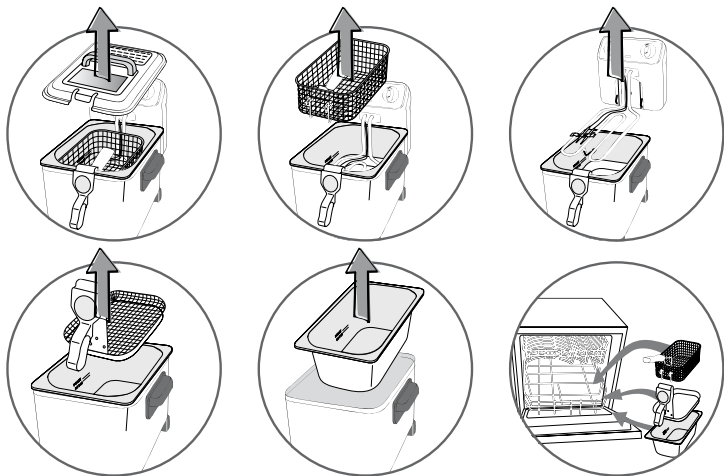

3

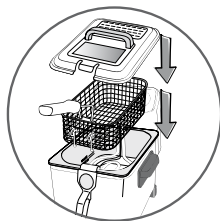
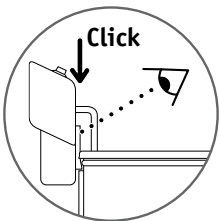
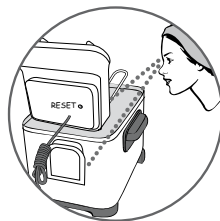
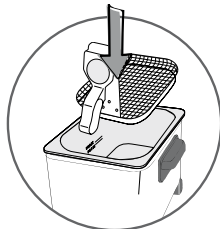
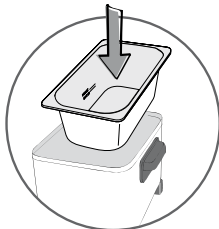
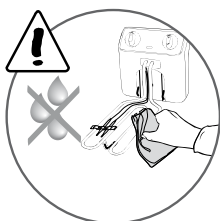
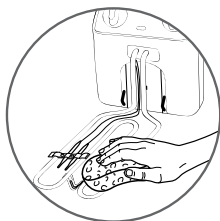
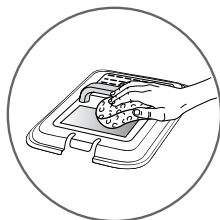



Model	3L	4L
Min.	2,2L	3,3L
Max.	3L	4L

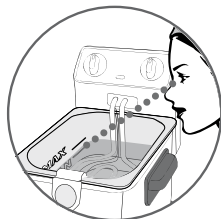

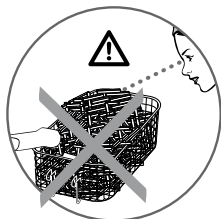
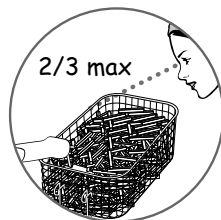
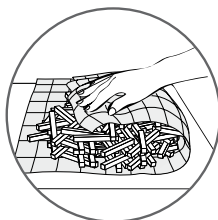
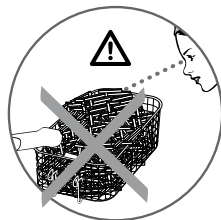
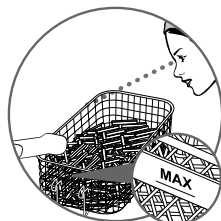
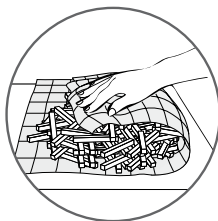



5

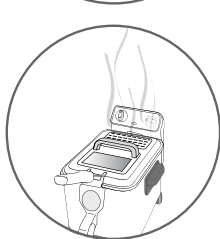
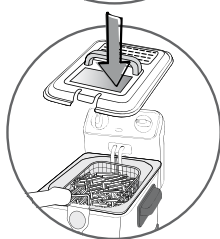
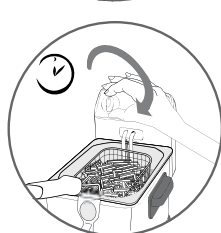
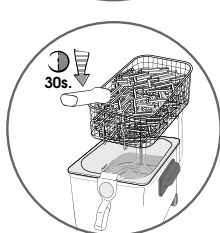
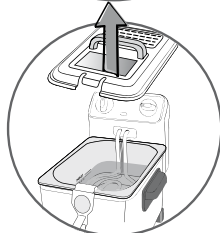
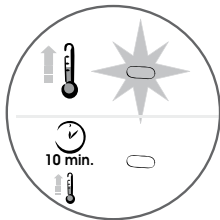
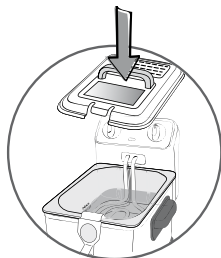
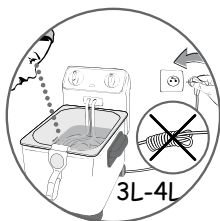
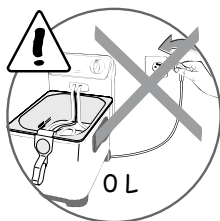

7

\* Selon modèle - Afhankelijk van de model - Je nach Modell - Depending on model - Secondo il modello - Según modelo - Consoante o modelo - Ανάλογα με το μοντέλο - Modele göre - Afhængigt af modellen - Beroende på modell - Avhengig av modell - Mallista riippuen - Ovisno o modelu - U zavisnosti od modela - Modelltöl fuggöfen - Според модела - Odvisno od modela - Zależnie od modelu - Podle typu - Podľa typu - Bizonyos típusoknál - В зависимости от модели - Залежно від моделі - În funcție de model - Vastavalt mudelitele - Atbilstoši paraugiem - Pagal modeliuis - بحسب الموديل - 根据型号

6

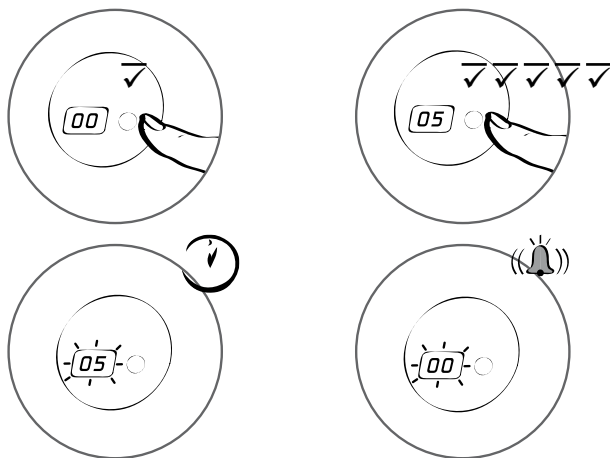

**RESET**

7

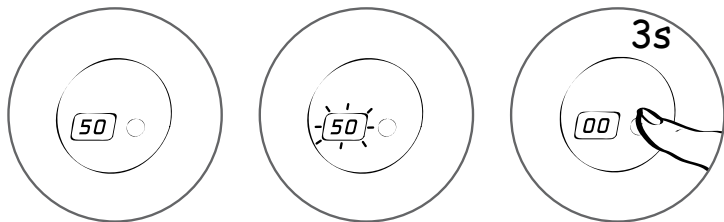

8



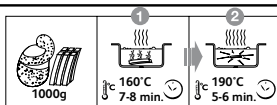

	Nb		°C	
 		1000g	① 160°C	7-8 min.
			② 190°C	5-6 min.
		600g	170°C	9-10 min.
		800g	180°C	9-10 min.
 		800g	① 160°C	6-7 min.
			② 190°C	3-4 min.
		400g	170°C	8-9 min.
		700g	180°C	9-10 min.
		400g	160°C	6-8 min.
	8-9		170°C	5-6 min.
<b>* * *</b>			°C	
 		450g	170°C	7-8 min.
		900g	190°C	8-9 min.
 		300g	170°C	6-7 min.
		600g	190°C	7-8 min.
	12		190°C	6-7 min.
 		1300g	190°C	7-8 min.
 		1200g	190°C	7-8 min.
	10-12		190°C	6-8 min.

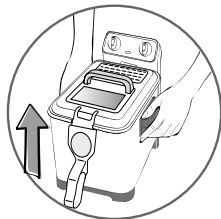
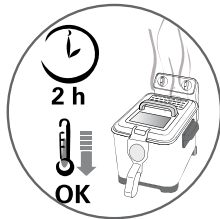
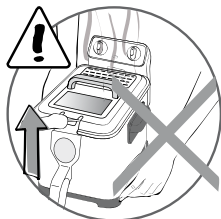
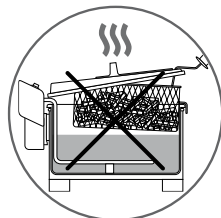
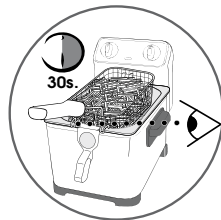
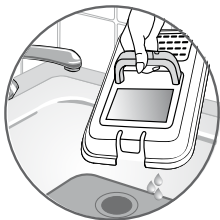
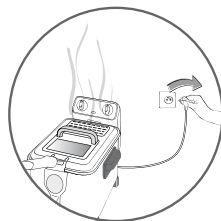
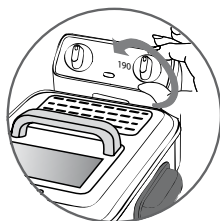
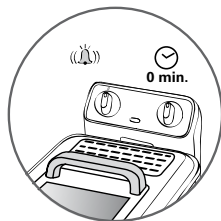

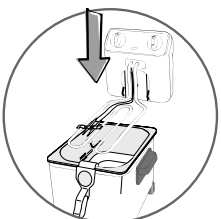
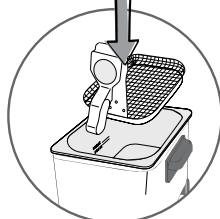
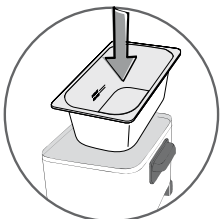
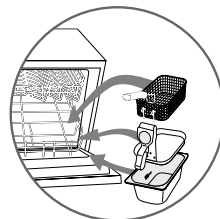
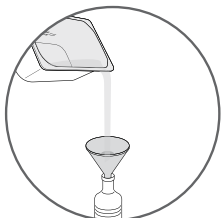
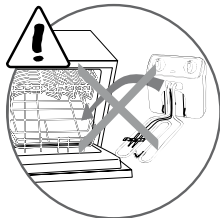
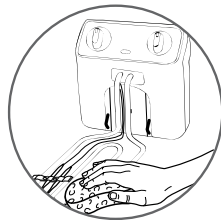
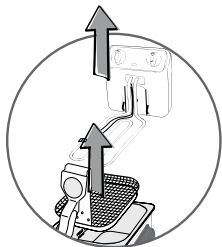
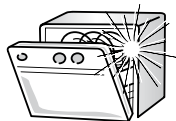

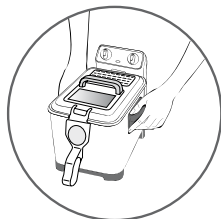
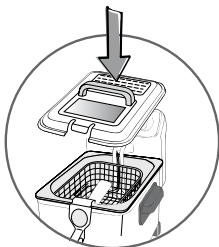
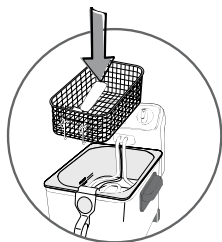

11

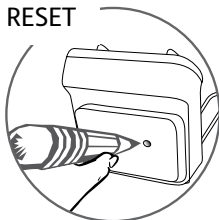
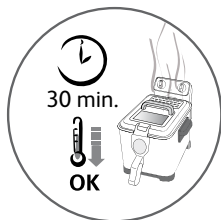
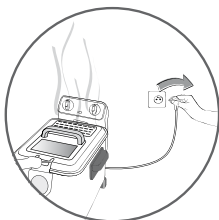
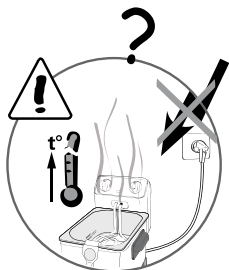

12



12

---

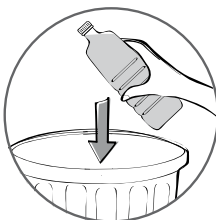
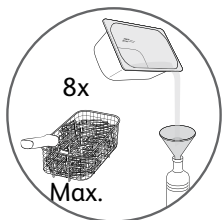

13





---





# INTERNATIONAL GUARANTEE COUNTRY LIST





## SMALL HOUSEHOLD APPLIANCES





			
<b>ARGENTINA</b>	0800-122-2732	2 años 2 years	GRUPE SEB ARGENTINA S.A. Billinghurst 1833 3° C1425DTK Capital Federal Buenos Aires
<b>ՀԱՅԱՍՏԱՆ ARMENIA</b>	010 55-76-07	2 տարի 2 years	«SEB Ուկրաինա խումբ» ընկերություն Խարկովի խճուղի, 201-203, 3-րդ հարկ Կիև, 02121 Ուկրաինա 2 տարի
<b>AUSTRALIA</b>	1300307824	1 year	Groupe SEB Australia PO Box 404 North Ryde, NSW, 1670
<b>ÖSTERREICH AUSTRIA</b>	01 890 3476	2 Jahre 2 years	GRUPE SEB DEUTSCHLAND GmbH Theodor-Stern-Kai 1 60596 Frankfurt
<b>البحرين BAHRAIN</b>	17716666	1 year	www.tefal-me.com
<b>БЕЛАРУСЬ BELARUS</b>	017 2239290	2 года 2 years	ЗАО «Группа СЕБ-Восток», Москва, 125171, Ленинградское шоссе, д.16А, строение 3, помещение XII
<b>BELGIQUE BELGIE BELGIUM</b>	070 23 31 59	2 ans 2 jaar 2 years	GRUPE SEB BELGIUM SA NV 25 avenue de l'Espérance - ZI 6220 Fleurus
<b>BOSNA I HERCEGOVINA</b>	Info-linija za potrošače 033 551 220	2 godine 2 years	SEB Developement Predstavništvo u BiH Valtera Perića 6/I 71000 Sarajevo
<b>BRASIL BRAZIL</b>	11 2915-4400	1 ano 1 year	Seb Comercial gAv Jornalista Roberto Marinho, 85, 19º andar 04576 – 010 São Paulo - SP
<b>БЪЛГАРИЯ BULGARIA</b>	0700 10 330	2 години 2 years	Груп Себ България ЕООД бул. България 58 С, ет 9, офис 30 1680 София
<b>CANADA</b>	1-800-418-3325	1 an 1 year	Groupe SEB Canada Inc. 36 Newmill Gate, Unit 2 Scarborough, ON M1V 0E2
<b>CHILE</b>	02 2 884 46 06	2 años 2 years	GRUPE SEB CHILE Comercial Ltda Avenida Santa María 0858, Providencia - Santiago
<b>COLOMBIA</b>	018000520022	2 años 2 years	GRUPE SEB COLOMBIA Apartado Aereo 172, Kilometro 1 Via Zipaquira Cajica Cundinamarca
<b>HRVATSKA CROATIA</b>	01 30 15 294	2 godine 2 years	SEB mku & p d.o.o. Sarajevska 29, 10000 Zagreb

			
<b>ČESKÁ REPUBLIKA CZECH REPUBLIC</b>	731 010 111	2 roky 2 years	Groupe SEB ČR s.r.o. Futurama Business Park (budova A) Sokolovská 651/136a 186 00 Praha 8
<b>DANMARK DENMARK</b>	44 66 31 55	2 år 2 years	GROUPE SEB NORDIC AS Tempovej 27 2750 Ballerup
<b>مصر EGYPT</b>	16622	سنة واحدة 1year	جروب سب ايجيبت القاهرة: ١٢١ شارع الحجاز، مصر الجديدة الإسكندرية: طريق ٤ مايو، سموحة
<b>EESTI ESTONIA</b>	668 1286	2 aastat 2 years	Groupe SEB Polska Sp. z o.o. Gdański Business Center II D ul. Inflancka 4C 00-189 Warsaw
<b>SUOMI FINLAND</b>	09 8946 150	2 vuotta 2 years	Groupe SEB Finland OY Pakkalankuja 6 01510 Vantaa
<b>FRANCE Continentale + Guadeloupe, Martinique, Réunion, St-Martin</b>	09 74 50 47 74	2 ans 2 years	GROUPE SEB France Service Consommateur Tefal 112 Ch. Moulin Carron, TSA 92002 69134 ECULLY Cedex
<b>DEUTSCHLAND GERMANY</b>	0212 387 400	2 Jahre 2 years	GROUPE SEB DEUTSCHLAND GmbH Theodor-Stern-Kai 1 60596 Frankfurt
<b>ELLADA GREECE</b>	2106371251	2 χρόνια 2 years	SEB GROUPE ΕΛΛΑΔΟΣ Α.Ε. Καβαλιεράτου 7 T.K. 145 64 K. Κηφισιά
<b>香港 HONG KONG</b>	8130 8998	1 year	SEB ASIA Ltd. 9/F, South Block, Skyway House 3 Sham Mong Road, Tai Kok Tsui, Kowloon Hong-Kong
<b>MAGYARORSZÁG HUNGARY</b>	06 1 801 8434	2 év 2 years	GROUPE SEB CENTRAL-EUROPE Kft. 2040 Budaörs, Puskás Tivadar út 14
<b>INDONESIA</b>	+62 21 5793 7007	1 year	GROUPE SEB INDONESIA (Representative office) Sudirman Plaza, Plaza Marein 8th Floor JL Jendral Sudirman Kav 76-78, Jakarta 12910, Indonesia
<b>ITALIA ITALY</b>	1 99 207 354	2 anni 2 years	GROUPE SEB ITALIA S.p.A. Via Montefeltro, 4 20156 Milano
<b>日本 JAPAN</b>	0570-077772	1年 1 year	株式会社グループセブジャパン 〒144-0042 東京都大田区羽田旭町11-1 羽田クロノゲート事務棟5F
<b>الأردن JORDAN</b>	5665505	1 year	www.tefal-me.com

			
<b>ҚАЗАҚСТАН KAZAKHSTAN</b>	727 378 39 39	2 жыл 2 years	ЖАҚ "ГРУППА СЕБ-ВОСТОК", Мәскеу, 125171, Ленинград тас жолы, 16А үй, 3- құрылыс, XII-ғимарат
<b>한국어 KOREA</b>	080-733-7878	1 year	(유)그룹 세브 코리아 서울특별시 종로구 종로1길 50, 더케이타워 B동 14층 03142
<b>الكويت KUWAIT</b>	1807777 Ext :2104	1 year	www.tefal-me.com
<b>LATVJA LATVIA</b>	6 616 3403	2 gadi 2 years	Groupe SEB Polska Sp. z o.o. Gdański Business Center II D ul. Inflancka 4C 00-189 Warsaw
<b>لبنان LEBANON</b>	4414727	1 year	www.tefal-me.com
<b>LIETUVA LITHUANIA</b>	5 214 0057	2 metai 2 years	Groupe SEB Polska Sp. z o.o. Gdański Business Center II D ul. Inflancka 4C 00-189 Warsaw
<b>LUXEMBOURG</b>	0032 70 23 31 59	2 ans 2 years	GRUPE SEB BELGIUM SA NV 25 avenue de l'Espérance - ZI 6220 Fleurus
<b>МАКЕДОНИЈА MACEDONIA</b>	(02) 20 50 319	2 години 2 years	Груп Себ България ЕООД бул. България 58 С, ет 9, офис 30 1680 София
<b>MALAYSIA</b>	603 7802 3000	2 years	GRUPE SEB MALAYSIA SDN. BHD Unit No. 402-403, Level 4, Uptown 2, No. 2, Jalan SS21/37, Damansara Uptown, 47400, Petaling Jaya, Selangor D.E Malaysia
<b>MEXICO</b>	(55) 52839354	1 año 1 year	Groupe Seb México S.A. de C.V. Calle Boulevard Miguel de Cervantes, Saavedra No 169 Piso 9, Col Ampliación Granada, C.P. 11520, Ciudad de México
<b>MOLDOVA</b>	22 224035	2 роки 2 years	ТОВ «Груп СЕБ Україна» 02121, Харківське шосе, 201-203, 3 поверх, Київ, Україна
<b>NEDERLAND The Netherlands</b>	0318 58 24 24	2 jaar 2 years	GRUPE SEB NEDERLAND B.V. De Schutterij 27 3905 PK Veenendaal
<b>سلطنة عمان OMAN</b>	24703471	1 year	www.tefal-me.com
<b>POLSKA POLAND</b>	801 300 420 koszt jak za połączenie lokalne	2 lata 2 years	Groupe SEB Polska Sp. z o.o. Gdański Business Center II D ul. Inflancka 4C 00-189 Warsaw



			
<b>PORTUGAL</b>	808 284 735	2 anos 2 years	GRUPE SEB IBÉRICA SA Urb. da Matinha Rua Projectada à Rua 3 Bloco1 - 3º B/D 1950 - 327 Lisboa
قطر <b>QATAR</b>	44485555	1 year	www.tefal-me.com
<b>REPUBLIC OF IRELAND</b>	01 677 4003	2 years	GRUPE SEB IRELAND Unit B3 Aerodrome Business Park, College Road, Rathcoole, Co. Dublin
<b>ROMANIA</b>	0 21 316 87 84	2 ani 2 years	GRUPE SEB ROMÂNIA Str. Ermil Pangratti nr. 13 011881 București
<b>РОССИЯ RUSSIA</b>	495 213 32 30	2 года 2 years	ЗАО «Группа СЕБ-Восток», Москва, 125171, Ленинградское шоссе, д.16А, строение 3, помещение XII
المملكة العربية السعودية <b>SAUDI ARABIA</b>	920023701	2 years	www.tefal-me.com
<b>SRBIJA SERBIA</b>	060 0 732 000	2 godine 2 years	SEB Développement Đorđa Stanojevića 11b 11070 Novi Beograd
<b>SINGAPORE</b>	6550 8900	2 years	GRUPE SEB (Singapore) Pte. Ltd. 3A International Business Park #12-04/05, ICON@IBP Singapore 609935
<b>SLOVENSKO SLOVAKIA</b>	232 199 930	2 roky 2 years	GRUPE SEB Slovensko, spol. s r.o. Cesta na Senec 2/A 821 04 Bratislava
<b>SLOVENIJA SLOVENIA</b>	02 234 94 90	2 leti 2 years	GRUPE SEB Slovensko, spol. s r.o. Cesta na Senec 2/A 821 04 Bratislava
<b>ESPAÑA SPAIN</b>	933 06 37 65	2 años 2 years	GRUPE SEB IBÉRICA S.A. C/ Almogàvers, 119-123, Complejo Ecourban 08018 Barcelona
<b>SVERIGE SWEDEN</b>	08 629 25 00	2 år 2 years	TEFAL - OBH Nordica Group AB Löfströms Allé 5 172 66 Sundbyberg
<b>SUISSE SCHWEIZ SWITZERLAND</b>	044 837 18 40	2 ans 2 Jahre 2 years	GRUPE SEB SCHWEIZ GmbH Thurgauerstrasse 105 8152 Glattpark
ประเทศไทย <b>THAILAND</b>	02 765 6565	2 years	GRUPE SEB THAILAND 2034/66 Italthai Tower, 14th Floor, n° 14-02, New Phetchburi Road, Bangkapi, Huaykwang, Bangkok, 10320
<b>TÜRKIYE TURKEY</b>	444 40 50	2 YIL 2 years	GRUPE SEB ISTANBUL AS Dereboyu Cd. Bilim Sk. Sun Plaza No:5 K:2 Maslak 34398 Istanbul
الإمارات العربية المتحدة <b>UAE</b>	8002272	1 year	www.tefal-me.com

			
<b>Україна UKRAINE</b>	044 300 13 04	2 роки 2 years	ТОВ «Груп СЕБ Україна» 02121, Харківське шосе, 201-203, 3 поверх, Київ, Україна
<b>UNITED KINGDOM</b>	0345 602 1454	2 years	GROUPE SEB UK LTD Riverside House, Riverside Walk Windsor, Berkshire, SL4 1NA
<b>U.S.A.</b>	800-395-8325	1 year	GROUPE SEB USA 2121 Eden Road Millville, NJ 08332
<b>VIETNAM</b>	1800-555521	2 năm 2 years	Vietnam Fan Joint Stock Company 25 Nguyen Thi Nho Str, Ward 9, Tan Binh Dist, HCM city

24/10/2018

## INTERNATIONAL GUARANTEE

**Date of purchase** / Date d'achat / Fecha de compra / Købsdato / Ostopäivä / Kjøpsdato / Inköpsdatum / Ostukuupäev / Pirkuma datums / Įsigijimo data / Data zakupu / Datum izročitve blaga / Datum kupovine / Vásárlás dátuma / Data achiziției / Дата на закупуване / Дата продажу / Чыгуулары ор. / Дата продажи / Сатылган күні / 購入日 / วันที่ซื้อ / 구입일자 / Датум на купување :

**Product reference** / Référence produit / Referencia del producto / Referencenummer / Tuotenumero / Artikelnummer / Produktreferens / Toote viitenumber / Produkta atsauces numurs / Gaminio numeris / Referenja produktu / Oznaka proizvoda / Tip aparata / Készülék típusa / Cod produs / Модел / Модель / Унифік. / Модель / Улгісі / 製品リファレンス番号 / รุ่นผลิตภัณฑ์ / 제품명 / Податоци за производот:

**Retailer name and address** / Nom et adresse du revendeur / Nombre y dirección del minorista / Forhandler navn & adresse / Jälleenmyyjän nimi ja osoite / Forhandler navn og adresse / Återförsäljarens namn och adress / Müüja kauplus ja aadress / Veikala nosaukums un adrese / Parduotuvės pavadinimas ir adresas / Nazwa i adres sprzedawcy / Naziv i adresa prodajnog mjesta / Naziv in naslov trgovine / Forgalmazó neve és címe / Numele și adresa vânzătorului / Търговски обект / Назва та адреса продавця / Чыгуулары үчүн үчүн үчүн үчүн үчүн / Название и адрес продавца / Сатушының атауы мен мекен-жайы / 販売店名、住所 / ชื่อและที่อยู่ของห้าง/ร้านที่ซื้อ / 소매점 이름과 주소 / Име и адреса на продавач :

**Distributor stamp** / Cachet / Sello del distribuidor / Forhandler stempel / Jälleenmyyjän leima / Forhandler stempel / Återförsäljarens stämpel / Tempel / Zimogs / Antspaudas / Pieczęć sprzedawcy / Pečat distributera / Pečat trgovine / Forgalmazó pecsétje / Ștampila vânzătorului / Печат на търговския обект / Печатка продавця / Чүпүр. / Печать продавца / Сатушының мөрі / 販売店印 / ตราประทับของห้าง/ร้านที่ซื้อ / 소매점 직인 / Печат на дистрибутер :



**Ref : NC00151047**