

# Freshboost Blender

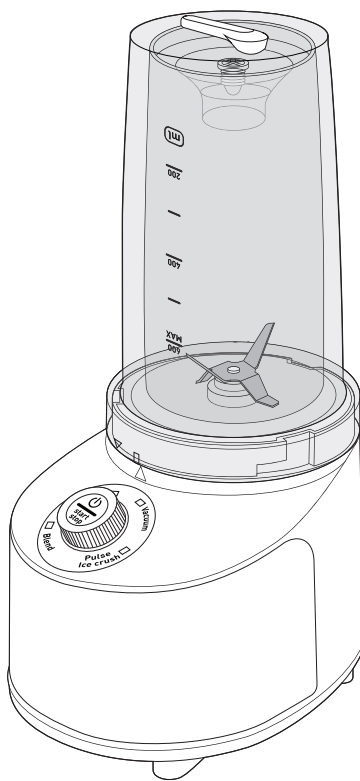

FR

Lire attentivement le livret consignes de sécurité et ce livret avant la première utilisation.

EN

Read safety instructions and booklet carefully before using for the first time.

DE

Lesen Sie vor der ersten Benutzung die Sicherheitshinweise und die Broschüre sorgfältig durch.

NL

Neem vóór het eerste gebruik dit boekje en het boekje met de veiligheidsvoorschriften aandachtig door.

IT

Leggere con attenzione il libretto sulle norme di sicurezza e questo libretto, al primo utilizzo.

ES

Lea detenidamente las instrucciones de seguridad y este folleto antes de utilizar el aparato por primera vez.

PT

Leia atentamente as instruções de segurança bem como este folheto antes da primeira utilização.

EL

Διαβάστε προσεκτικά το φυλλάδιο με τις οδηγίες ασφαλείας καθώς και αυτό το φυλλάδιο πριν χρησιμοποιήσετε τη συσκευή για πρώτη φορά.

DA

Læs hæftet med sikkerhedsanvisninger og dette hæfte omhyggeligt, inden apparatet tages i brug første gang.

SV

Läs häftet med säkerhetsinstruktioner och det här häftet noga innan du använder apparaten första gången.

FI

Lue turvallisuuohjekirjanen ja tämä kirjanen huolellisesti ennen ensimmäistä käyttökertaa.

NO

Les nøye heftet med sikkerhetsinstruksjoner og dette heftet før første gangs bruk.

TR

Kullanmadan önce güvenlik talimatları kitapçığını ve bu kitapçığı dikkatlice okuyun.

RU

Перед первым использованием прибора внимательно ознакомьтесь с правилами техники безопасности и данной инструкцией.

UK

Прочитайте інструкції з техніки безпеки і цю брошуру перед використанням уперше.

KK

Бірінші рет қолданарда қауіпсіздік нұсқаулығын мұқият оқып шығыңыз.

RO

Citiți cu atenție manualul cu instrucțiunile de siguranță și această broșură înainte de prima utilizare.

SL

Pred prvo uporabo natančno preberite navodila za varno uporabo in ta navodila.

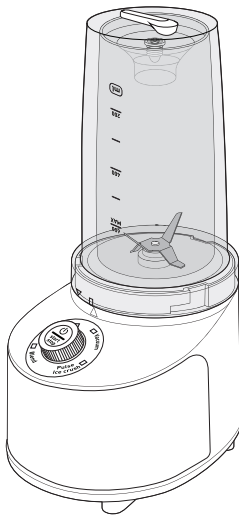



*Pre prve upotrebe pažljivo pročitajte knjižicu s bezbednosnim uputstvima i ovu knjižicu.*

SR

*Molimo da prije prve uporabe pažljivo pročitate sigurnosne upute i upute za uporabu.*

HR

*Prije prve upotrebe pročitajte knjižicu sa sigurnosna uputstva i knjižicu o upotrebi.*

BS

*Прочетете внимателно книжката и съветите за безопасност в нея преди първата употреба.*

BG

*Lugege enne esimest kasutuskorda tähelepanelikult ohutusnõudeid ja seda brošüüri.*

ET

*Pirms pirmās lietošanas uzmanīgi izlasiet drošības norādījumus un šo informāciju.*

LV

*Prieš naudodami prietaisą pirmą kartą įdėmiai perskaitykite saugos instrukciją ir šią instrukciją.*

LT

*Przed pierwszym korzystaniem z urządzenia przeczytaj uważnie książkę z zasadami bezpieczeństwa oraz niniejszą instrukcję.*

PL

*Před prvním použitím si pozorně přečtete brožuru s bezpečnostními pokyny a tuto brožuru.*

CS

*Pred prvým použitím si pozorne prečítajte brožúru „Bezpečnostné odporúčania a použitie“.*

SK

*Az első használat előtt figyelmesen olvassa el a biztonsági előírásokról szóló brosúrát és a jelen brosúrát.*

HU

*อ่านคำแนะนำเพื่อความปลอดภัยและคู่มือการใช้งานอย่างละเอียดก่อนการใช้งานเป็นครั้งแรก*

TH

*처음 사용 전 안전지침과 현 책자를 잘 읽어 두시기 바랍니다.*

KO

*y ọc số tay hướng dẫn an toàn v cu n số tay này trước khi sử dụng.*

VI

*使用前・請仔細閱讀安全建議手冊和說明書。*

ZH

*Sila baca buku arahan keselamatan dan buku ini sebelum penggunaan untuk kali pertama.*

MS

*اقرأ كتاب تعليمات الأمان بعناية قبل أول استخدام.*

AR

*قبل از استفاده، دفترچه راهنمای ایمنی و این دفترچه را مطالعه کنید.*

FA

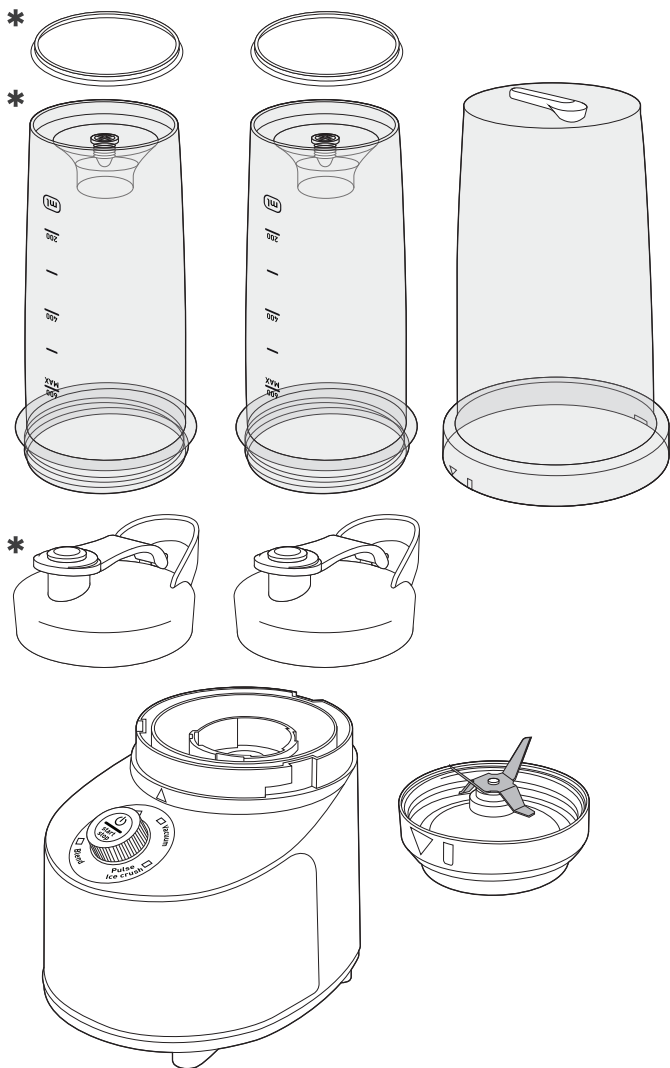



*Selon modèle / Depending on model*  
*Je nach Modell / Afhankelijk van het model*  
*Secondo il modello / En función del modelo*  
*Consoante o modelo / ανάλογα με το μοντέλο*  
*Modelafhængig / Beroende på modell*  
*Mallista riippuen / Avhengig av modell*  
*Modele göre / в зависимости от модели*  
*залежно від моделі / γλιγίγε байланысты*  
*În funcție de model / Glede na modelu*  
*Uzavisnosti od modela / Ovisno o modelu / Ovisno o modelu*  
*В зависимости от модели / Soltuvalt mudelist*  
*Atbilstoši modelim / Priklausomai nuo modelio*  
*W zależności od modelu / Podle modelu*  
*Podľa modelu / Modelltöl függően*  
*แตกต่างกันไปในแต่ละรุ่น / 모델에 따라 다름*  
*Tùy theo mẫu / 視乎型號而定*  
*Bergantung pada model*  
*بر حسب الموديل / بر حسب مدل*

1

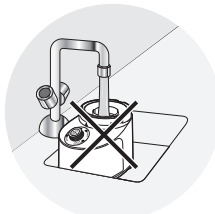

2.1

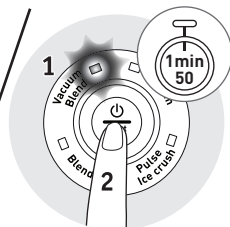
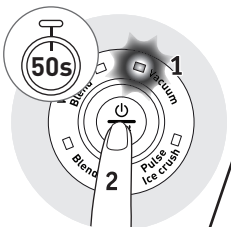
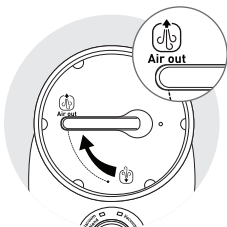
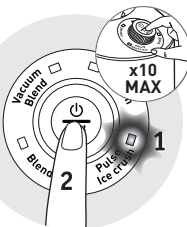
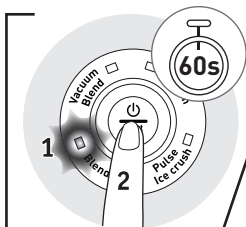
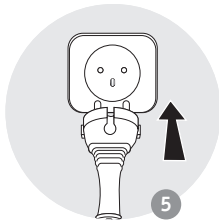
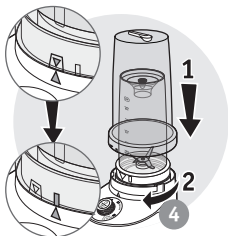
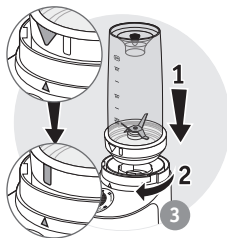
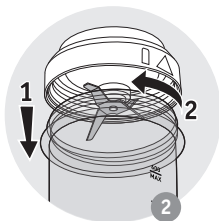



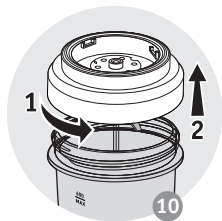
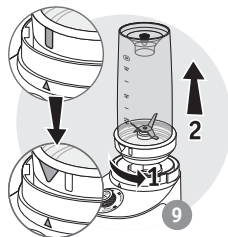
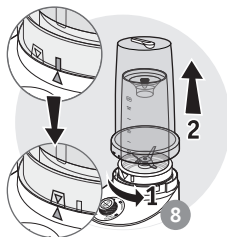
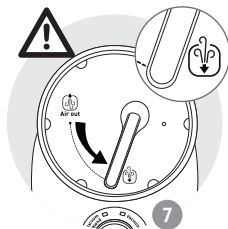

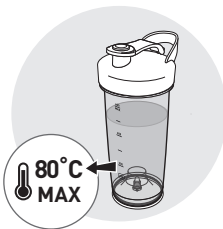
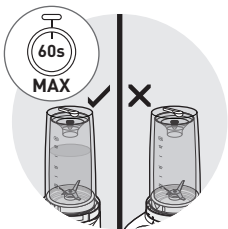
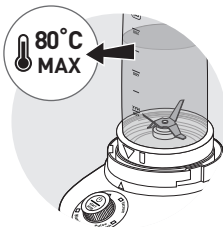
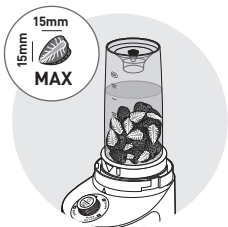

2.2













3





			
	✗	✗	✓
	✓	✓	✓
	✓	✓	✗
	✓	✗	✓

			
	 130 g + 270 g	 Vacuum Blend	1min 50
	 130 g + 270 g	 Vacuum Blend	1min 50
* 	 80 g	 Pulse	5 sec

**INTERNATIONAL GUARANTEE: COUNTRY LIST  
SMALL HOUSEHOLD APPLIANCES**

ARGENTINA	0800-122-2732	EGYPT مصر	16622	SLOVENIJA SLOVENIA	02 234 94 90	MALAYSIA	603 7802 3000
ՀԱՅԱՍՏԱՆ ARMENIA	010 55-76-07	EESTI ESTONIA	668 1286	ΕΛΛΑΔΑ GREECE	2106371251	MEXICO	(01800) 112 8325
AUSTRALIA	1300307824	SUOMI FINLAND	9 8946 150	香港 HONG KONG	8130 8998	MOLDOVA	22 224035
ÖSTERREICH AUSTRIA	01 890 3476	FRANCE Continentale + Guadeloupe, Martinique, Réunion, St-Martin	09 74 50 47 74	MAGYARORSZÁG HUNGARY	06 1 801 8434	NETERLAND The Netherlands	0318 58 24 24
البحرين BAHRAIN	17716666	DEUTSCHLAND GERMANY	0212 387 400	INDONESIA	+62 21 5793 7007	NEW ZEALAND	0800 700 711
БЕЛАРУСЬ BELARUS	017 2239290	عمان سلطنة OMAN	24703471	ITALIA ITALY	1 99 207 354	NORGE NORWAY	22 96 39 30
BELGIË BELGIE BELGIUM	070 23 31 59	POLSKA POLAND	801 300 420 koszt jak za połączenie lokalne	日本 JAPAN	0570-07772	SOUTH AFRICA	www.tefal.co.za
BOSNA I HERCEGOVINA	Info-linija za potrošače 033 551 220	PORTUGAL	808 284 735	الأردن JORDAN	5665505	ESPAÑA SPAIN	933 06 37 65
BRASIL BRAZIL	11 2915-4400	قطر QATAR	44485555	ҚАЗАҚСТАН KAZAKHSTAN	727 378 39 39	SVERIGE SWEDEN	08 629 25 00
БЪЛГАРИЯ BULGARIA	0700 10 330	REPUBLIC OF IRELAND	01 677 4003	한국어 KOREA	080-733-7878	SUISSE SCHWEIZ SWITZERLAND	044 837 18 40
CANADA	1-800-418-3325	ROMANIA	0 21 316 87 84	الكويت KUWAIT	1807777 Ext : 2104	ประเทศไทย THAILAND	02 765 6565
CHILE	02 2 884 46 06	РОССИЯ RUSSIA	495 213 32 30	LATVIJA LATVIA	6 616 3403	TÜRKIYE TURKEY	444 40 50
COLOMBIA	018000520022	السعودية العربية المملكة SAUDI ARABIA	920023701	لبنان LEBANON	4414727	المملكة العربية الامارات UAE	8002272
HRVATSKA CROATIA	01 30 15 294	SERBIJA SERBIA	060 0 732 000	LIETUVA LITHUANIA	5 214 0057	Україна UKRAINE	044 300 13 04
ČESKA REPUBLIKA CZECH REPUBLIC	731 010 111	SINGAPORE	6550 8900	LUXEMBOURG	0032 70 23 31 59	UNITED KINGDOM	0345 602 1454
DANMARK DENMARK	44 66 31 55	SLOVENSKO SLOVAKIA	232 199 930	МАКЕДОНИЈА MACEDONIA	(02) 20 50 319	U.S.A.	800-395-8325
20/10/2017		VIETNAM	1800-55521				

**Date of purchase / Date d'achat / Fecha de compra / Kobsdato / Ostopriivä / Kjøpsdato / Inköpsdatum / Ostukupulev / Pirkuma datums / Įsigijimo data / Data zakupu / Datum izročitve blaga / Datum kupovine / Vásárlás dátuma / Data achiziției / Дата на закупуване / Дата продажы / Чыгулурһ рр. / Дата продажы / Сатылган күні / 購入日 / วันที่ซื้อ / 구입일자 / Датум на купување :**

**Product reference / Référence produit / Referencia del producto / Referencennummer / Tuotonumero / Artikkelnummer / Produktreferens / Toote viitenumber / Produkta atsauces numurs / Gaminio numeris / Referenca produktu / Oznaka proizvoda / Tip aparata / Készülék típusa / Cod produs / Модел / Модел / Πηγήλ. / Модель / Yarıci / 製品リファレンス番号 / รุ่นผลิตภัณฑ์ / 제품명 / Податоци за произвождо:**

**Retailer name and address / Nom et adresse du revendeur / Nombre y dirección del minorista / Forhandler navn & adresse / Jälleenmyyjän nimi ja osoite / Forhandler navn og adresse / Återförsäljarens namn och adress / Müüja kauplus ja address / Veikala nosaukums un adrese / Parduotuvės pavadinimas ir adresas / Naziv i adresa sprodavacy / Naziv i adresa prodajnog mjesta / Naziv in naslov trgovine / Forgalmazó neve és címe / Numele și adresa vânzătorului / Търговския обект / Назва та адреса продаваца / Чыгулурһ рр.түбүтүмүндө и хууулу. / Название и адрес продавца / Сатушынын атауы мен мекен-жайы / 販売店名、住所 / ชื่อและที่ตั้งของห้างร้านที่ซื้อ / 소매점 이름과 주소 / Име и адреса на продавач :**

**Distributor stamp / Cachet / Sello del distribuidor / Forhandler stempel / Jälleenmyyjän leima / Forhandler stempel / Återförsäljarens stämpel / Tempel / Žmogus / Antspaudas / Piecēķis sprodavacy / Pečat distributera / Pečat trgovine / Forgalmazó pecsétje / Stampila vânzătorului / Печат на търговския обект / Печатка продаваца / Чыгул. / Печать продаваца / Сатушынын мөрү / 販売店印 / ตราประทับของห้างร้านที่ซื้อ / 소매점 직인 / Печат на дистрибутер :**

8020000919-02