

AVENTAGE

Blu-ray Disc Player

BD-A1040

***Инструкция по эксплуатации
Owner's Manual***

Русский

English

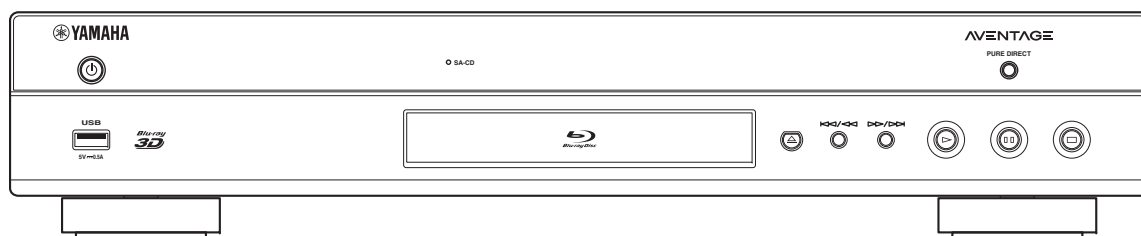

Предупреждение: внимательно прочитайте это перед использованием аппарата.

- 1 Для обеспечения наилучшего результата, пожалуйста, внимательно прочитайте данную инструкцию. Храните ее в безопасном месте для будущих справок.
- 2 Данный аппарат следует устанавливать в хорошо проветриваемом, прохладном, сухом месте, вдали от прямого воздействия солнечных лучей, источников тепла, вибрации, пыли, влаги и/или холода. Для надлежащей вентиляции необходимо обеспечить следующие минимальные просветы.
Сверху: 10 см
Сзади: 10 см
По сторонам: 10 см
- 3 Во избежание шумов и помех, данный аппарат следует размещать на некотором расстоянии от других электрических приборов, двигателей или трансформаторов.
- 4 Во избежание накопления влаги внутри данного аппарата, что может вызвать электрошок, пожар, привести к поломке данного аппарата, и/или представлять телесное повреждение, не следует размещать данный аппарат в среде, подверженной резким изменениям температуры с холодной на жаркую, или в среде с повышенной влажностью (например, в комнате с увлажнителем воздуха).
- 5 Не устанавливайте данный аппарат в местах, где есть риск падения других посторонних объектов на данный аппарат и/или где данный аппарат может подвергнуться попаданию капель брызг жидкостей. На крышке данного аппарата, не следует располагать:
 - Другие компоненты, так как это может привести к поломке и/или обесцвечиванию поверхности данного аппарата.
 - Горящие объекты (например, свечи), так как это может привести к пожару, поломке данного аппарата и/или представлять телесное повреждение.
 - Емкости с жидкостями, так как при их падении жидкости могут вызвать поражение пользователя электрическим током и/или привести к поломке данного аппарата.
- 6 Во избежание прерывания охлаждения данного аппарата, не следует покрывать данный аппарат газетой, скатертью, занавеской и т.д. Повышение температуры внутри данного аппарата может привести к пожару, поломке данного аппарата и/или представлять телесное повреждение.
- 7 Пока все соединения не завершены, не следует подключать данный аппарат к розетке.
- 8 Не используйте данный аппарат, установив его верхней стороной вниз. Это может привести к перегреву и возможной поломке.
- 9 Не применяйте силу по отношению к переключателям, ручкам и/или проводам.
- 10 При отсоединении силового кабеля питания от розетки, вытягивайте его, удерживая за вилку; ни в коем случае не тяните кабель.
- 11 Не применяйте различные химические составы для очистки данного аппарата; это может привести к разрушению покрывающего слоя. Используйте чистую сухую ткань.
- 12 Используйте данный аппарат с соблюдением напряжения, указанном на данном аппарате. Использование данного аппарата при более высоком напряжении, превышающем указанное, является опасным, и может стать причиной пожара, поломки данного аппарата, и/или представлять телесное повреждение. Yamaha не несет ответственности за любую поломку или ущерб вследствие использования данного аппарата при напряжении, не соответствующем указанному напряжению.
- 13 Во избежание поломки от молнии, отключите силовой кабель питания от розетки во время электрической бури.
- 14 Не пробуйте модифицировать или починить данный аппарат. При необходимости свяжитесь с квалифицированным сервисным центром Yamaha. Корпус аппарата не должен открываться ни в коем случае.
- 15 Если вы не собираетесь использовать данный аппарат в течение продолжительного промежутка времени (например, во время отпуска), отключите силовой кабель переменного тока от розетки.
- 16 Перед тем как прийти к заключению о поломке данного аппарата, обязательно изучите раздел “Устранение неисправностей”, описывающий часто встречающиеся ошибки во время использования.
- 17 Перед перемещением данного аппарата, установите данный аппарат в режим ожидания нажатием кнопки , и отсоедините силовой кабель переменного тока от розетки.
- 18 При внезапном изменении окружающей температуры образовывается конденсация. Отсоедините силовой кабель питания от сети и не пользуйтесь аппаратом.
- 19 Аппарат может нагреваться при его продолжительном использовании. Отключите питание, затем дайте аппарату остыть.
- 20 Данный аппарат следует устанавливать возле розетки переменного тока, куда можно свободно протянуть силовой кабель.
- 21 Батарейки не должны подвергаться нагреву от солнечных лучей, огня или похожих источников.

Не используйте данное устройство на расстоянии менее 22 см от людей с электронным стимулятором сердца или имплантированным дефибриллятором.

Данный аппарат считается не отключенным от источника переменного тока все то время, пока он подключен к розетке, даже если данный аппарат находится в выключенном положении через . Данное положение является режимом ожидания. В этом режиме электропотребление данного аппарата снижается до минимума.

Если сетевая вилка или приборный соединитель используется в качестве выключающего устройства, то выключающее устройство должно оставаться полностью исправным.

ПРЕДУПРЕЖДЕНИЕ
ВО ИЗБЕЖАНИЕ ПОЖАРА ИЛИ УДАРА ЭЛЕКТРИЧЕСКИМ ТОКОМ НЕ ПОДВЕРГАЙТЕ ДАННЫЙ АППАРАТ ВОЗДЕЙСТВИЯМ ДОЖДЯ ИЛИ ВЛАГИ.

Лазерный компонент данного изделия может выделять радиацию, превышающую ограниченный уровень радиации для Класса 1.

Содержание

1

1. Введение

Возможности этого проигрывателя	2
Широкий набор поддерживаемых видов дисков и форматов файлов.....	2
Широкий сетевой функционал.....	2
Простота настройки и эксплуатации.....	2
Функции воспроизведения высококачественного звука.....	2
Прилагаемые компоненты	2
О дисках и файлах	3
Типы дисков/файлов, которые можно использовать с этим проигрывателем.....	3
Загрузка диска.....	4
Меры предосторожности при обращении с диском.....	5
Примечание по просмотру видеоизображений в формате 3D.....	5
Технология Sinavia.....	5
Органы управления и функции	6
Передняя панель.....	6
Задняя панель.....	7
Пульт дистанционного управления.....	8

2. Подключение

Подключение аудио/видео	12
Подключение к телевизору через аудио/видео ресивер.....	13
Подключение к телевизору напрямую.....	13
Подключение к телевизору и аудиооборудованию.....	14
Сетевое подключение	15
Беспроводное соединение.....	15
Проводное соединение.....	15
Настройка сервера DLNA.....	16
USB-подключение	17
Другие подключения	18
Подключение к гнездам REMOTE CONTROL.....	18
Подключение кабеля питания.....	18

3. Воспроизведение

Начальные установки	19
Настройка с помощью функции простой установки.....	19
Настройка беспроводного соединения.....	19
Меню HOME	20
Воспроизведение фотографий, музыки и видео.....	20
Использование сетевых служб	22
О Dropbox™.....	23
О веб-альбомах Picasa™.....	23
О YouTube™.....	23
Воспроизведение музыки через Bluetooth®	24
Сопряжение устройства Bluetooth с данным проигрывателем.....	24
Воспроизведение содержимого устройства Bluetooth.....	25
Воспроизведение фотографий и видеофрагментов со смартфона на экране телевизора (Miracast™)	26
Управление проигрывателем с мобильных устройств (AV CONTROLLER)	26
Расширенные операции воспроизведения	27
Экранное меню.....	27
Меню состояния.....	28
Программное воспроизведение.....	29
Использование поиска.....	29
Использование функций BONUSVIEW™ и BD-Live™.....	29
Использование функции “Картинка в картинке” (воспроизведение вторичного видео/аудио).....	30
Использование функции BD-Live™.....	30

4. Установки

Меню УСТАНОВКИ	31
Пример использования меню УСТАНОВКИ.....	33
Общие установки.....	34
Настройка дисплея.....	37
Настройка звука.....	38
Информация о системе.....	39

Форматы аудиовыходов.....	40
О форматах вывода изображения через HDMI.....	41
Обновление программного обеспечения	42
Обновление программного обеспечения.....	42

2

5. Дополнительная информация

3

Устранение неисправностей	43
Питание.....	43
Основные операции.....	43
Воспроизведение диска.....	43
Изображение.....	44
Звук.....	44
Сеть.....	45
Bluetooth.....	46
Сообщения на экране.....	46
Глоссарий	47
Технические характеристики	49
Общая часть.....	49
Аудиохарактеристики.....	49
Входные/выходные терминалы.....	49
Авторское право.....	49
Указатель	51

4

5

(в конце данного руководства)
Information about third party software licenses...

По мере необходимости будет выпускаться программное обеспечение с новыми функциями и улучшениями. Рекомендуется регулярно обновлять программное обеспечение проигрывателя до последней версии. Для получения дополнительной информации см. раздел “Обновление программного обеспечения” (стр. 42).

■ О данном руководстве

- Данное руководство описывает процесс управления проигрывателем с помощью пульта дистанционного управления (кроме случаев, когда пульт отсутствует). Некоторые действия также можно выполнять с помощью кнопок на лицевой панели.
- В примечаниях содержится важная информация о безопасности и инструкции по эксплуатации. Советы соответствуют подсказкам по эксплуатации.
- Данное руководство было отпечатано до начала производства изделия. Внешний вид и характеристики устройства могут быть изменены в результате улучшения характеристик и т. д. В случае расхождения данного руководства с возможностями изделия, функции изделия имеют приоритет.

Значки, используемые в данном руководстве пользователя

Значки указывают на кнопки/функции, доступные для данного формата. Для получения дополнительной информации о поддерживаемых типах дисков и форматах см. стр. 3.

- BD** : BD-Video
- DVD** : DVD-Video, DVD-VR, DVD+VR, DVD-Audio
- CD** : Audio CD, Super Audio CD
- VIDEO** : Видеофайлы
- MUSIC** : Аудиофайлы
- PHOTO** : Фотографии

Русский

Возможности этого проигрывателя



■ Широкий набор поддерживаемых видов дисков и форматов файлов

- Blu-ray™, DVD, SA-CD и CD (стр. 27)
- Blu-ray 3D™ (стр. 12), BONUSVIEW™ и BD-Live™ (стр. 29)
- Видео, музыка и файлы фотографий на дисках DVD-R/RW, CD-R/RW и запоминающих устройствах USB (стр. 20)

■ Широкий сетевой функционал

- Воспроизведение содержимого сервера DLNA (ПК или сетевое хранилище данных) (стр. 20)
- Воспроизведение потокового содержимого различных сетевых служб (стр. 22)
- Воспроизведение музыки через Bluetooth® (стр. 24)
- Управление проигрывателем с мобильных устройств (AV CONTROLLER) по сети (стр. 26)
- Воспроизведение фотографий и видеофрагментов со смартфона на экране телевизора (Miracast™) (стр. 26)

■ Простота настройки и эксплуатации

- Простая и быстрая начальная настройка (стр. 19)
- Автоматическая настройка беспроводной сети с помощью WPS (Wi-Fi Protected Setup, Настройка защиты Wi-Fi) (стр. 19)
- Обновление программного обеспечения по сети или с запоминающего устройства USB (стр. 42)
- Последовательное управление телевизором, аудио/видео ресивером и проигрывателем (HDMI контроль) (стр. 34)

■ Функции воспроизведения высококачественного звука

- Поддержка звука до 192 кГц/24 бит (стр. 3)
- Вывод сигнала в режиме DSD и PCM для воспроизведения дисков SA-CD (стр. 4)
- Поддержка формата DVD-Audio (стр. 3)

Прилагаемые компоненты

Убедитесь, что к изделию прилагаются следующие аксессуары.

Пульт дистанционного управления



Батарейки (42)
(AAA, R03, UM-4)

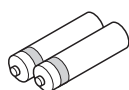

Кабель питания

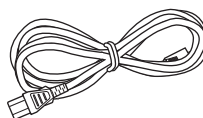

■ Типы дисков/файлов, которые можно использовать с этим проигрывателем

- На этом проигрывателе можно воспроизводить диски диаметром 12 см и 8 см. Не используйте адаптер 12 см для дисков 8 см.
- Используйте диски, соответствующие совместимым стандартам, что обозначается наличием официальных логотипов на этикетке диска. Воспроизведение дисков, не соответствующих данным стандартам, не гарантируется. Кроме того, не гарантируется качество изображения или качество звука даже в том случае, если данные диски могут быть воспроизведены.

Тип носителя	Формат записи
BD-ROM/BD-R/BD-RE	BD-Video/файлы с данными
DVD-ROM	DVD-Video/DVD-Audio
DVD-R/DVD-R DL/DVD-RW	DVD-Video/DVD-VR/AVCHD/файлы с данными
DVD+R/DVD+R DL/DVD+RW	DVD-Video/DVD+VR/AVCHD/файлы с данными
CD-ROM	CDDA/HDCD
CD-R/CD-RW	CDDA/файлы с данными
SA-CD	SA-CD
USB*	Файлы с данными
DLNA	Файлы с данными

* Этот проигрыватель совместим с запоминающими устройствами USB с файловой системой FAT 16/32 или NTFS.

Поддерживаемые форматы аудиофайлов MUSIC	Поддерживаемые форматы видеофайлов VIDEO	Поддерживаемые форматы файлов фотографий PHOTO
MP3 (.mp3) *1 WMA (.wma) *2 AAC (.aac/.m4a) WAV (.wav) *3 FLAC (.flac) *3 ALAC (.m4a) *3	DivX (.divx) MKV с данными в формате DivX (.mkv) MKV с данными в формате H.264 (.mkv) MPEG PS (.mpeg/.mpg) MPEG TS (.ts) MPEG-4 (.mp4) VOB (.vob) AVI (.avi) ASF (.asf) WMV (.wmv) *4	JPEG (.jpeg/.jpg) GIF (.gif) PNG (.png)

*1 Частота дискретизации в диапазоне 32–48 кГц (стерео) и битрейт в диапазоне 8-320 Кбит/с

*2 Частота дискретизации в диапазоне 32–48 кГц (стерео) и битрейт в диапазоне 32-192 Кбит/с

*3 Частота дискретизации до 192 кГц/24 бит (LPCM/стерео)









*4 WMV9 (максимальное разрешение: 1920 x 1080)



Примечания

- Воспроизведение файлов, перечисленных в списке, не гарантируется в зависимости от способов создания файла или использованных кодеков.
- Воспроизведение всех файлов на диске, запоминающем устройстве USB или в сети не гарантируется.
- Файлы, защищенные авторским правом, не удастся воспроизвести.
- При использовании DLNA файл должен соответствовать требованиям сервера DLNA.

Информация об управлении регионами видеофрагментов Blu-ray/DVD

- Видеопроеигрыватели и диски Blu-ray/DVD имеют региональные коды, определяющие регионы, в которых диск может быть воспроизведен. Проверьте метку с кодом региона на задней панели проигрывателя.
- Для воспроизведения диска Blu-ray требуется проигрыватель с кодом региона, соответствующим коду региона диска, или с кодом региона “ABC”.
- Для воспроизведения диска DVD требуется проигрыватель с кодом региона, соответствующим коду региона диска, или с кодом региона “ALL”.

Информация об управлении регионами		
Место назначения	BD-Video	DVD-Video
США или Канада	Код региона “A” или “ABC” 	Номер региона “1” или “ALL” 
Европа	Код региона “B” или “ABC” 	Номер региона “2” или “ALL” 
Азия и Тайвань	Код региона “A” или “ABC” 	Номер региона “3” или “ALL” 
Центральная и Северная Америка	Код региона “A” или “ABC” 	Номер региона “4” или “ALL” 

Информация об управлении регионами		
Место назначения	BD-Video	DVD-Video
Австралия	Код региона "B" или "ABC" 	Номер региона "4" или "ALL" 
Россия	Код региона "C" или "ABC" 	Номер региона "5" или "ALL" 

Примечания

- Операции с видеодисками Blu-ray/DVD могут отличаться от пояснений в данном руководстве, а некоторые операции могут быть запрещены производителем диска.
- Если во время воспроизведения диска появляется экран меню или инструкции по работе, следуйте указанному процессу.
- Воспроизведение некоторых дисков может быть невозможным в зависимости от диска.
- Все носители записи, воспроизводимые на этом проигрывателе, должны быть финализированы.
- “Финализация” означает обработку записываемого диска записывающим устройством, с тем, чтобы его можно было воспроизводить в других проигрывателях/записывающих устройствах, в том числе и с помощью данного проигрывателя. На данном проигрывателе можно воспроизвести только финализированные диски. (Этот проигрыватель не оснащен функцией финализации дисков.)

О Super Audio CD (SA-CD)

- Аудиоформат, основанный на современных стандартах CD, но вмещающий больший объем информации, что позволяет обеспечить более высокое качество звука. Существует три типа дисков: однослойные, двуслойные и гибридные диски. Гибридные диски можно воспроизводить на существующих проигрывателях дисков CD, а также на проигрывателях дисков Super Audio CD, поскольку эти диски содержат информацию как в формате обычного аудио CD, так и в формате Super Audio CD.

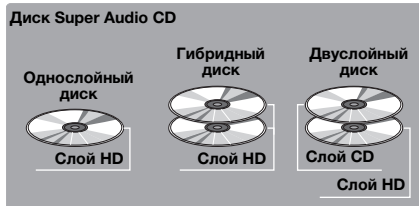

Совет

- Можно выбрать вывод аудиосигнала в режиме DSD или PCM (стр. 39).

Примечание

- Данное устройство не воспроизводит на дисплее передней панели текстовые данные, содержащиеся на диске.

■ Загрузка диска

- Диск должен быть расположен таким образом, чтобы этикетка была наверху.
- В случае, если диск записан с обеих сторон, разместите его так, чтобы сторона для воспроизведения была внизу.

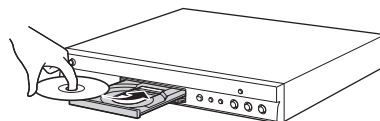

Примечания



- В зависимости от диска и настроек проигрывателя воспроизведение может начаться автоматически.
- В зависимости от диска сначала может появиться меню.
- Время загрузки диска может варьировать в зависимости от диска.

■ Меры предосторожности при обращении с диском

Не допускайте появления царапин и попадания пыли

- Диски Blu-ray, DVD и CD чувствительны к пыли, отпечаткам пальцев и особенно к царапинам. Поцарапанные диски не могут воспроизводиться. Обращайтесь с дисками осторожно и храните их в безопасном месте.

Правильное хранение дисков

Поместите диск в центр футляра для диска и храните их в вертикальном положении.	
Не хранить диски в местах, подверженных попаданию прямых солнечных лучей, рядом с нагревательными приборами или в местах с высокой влажностью.	
Не роняйте диски и не подвергайте их сильной вибрации или ударам.	
Не храните диски в местах с высоким содержанием пыли или повышенной влажностью.	

Меры предосторожности при очистке



- Если поверхность загрязнена, осторожно вытрите ее мягкой, увлажненной (только водой) тканью. Протирая диски, всегда проводите тканью от центрального отверстия по направлению к внешнему краю.



- Не используйте аэрозоли для стирания надписей, бензин, обрабатывающие средства, жидкость для снятия статического электричества или любые другие растворители.

- Старайтесь не прикасаться к поверхности.
- Не приклеивайте на диск бумагу или наклейки.
- Если рабочая поверхность диска загрязнена или поцарапана, проигрыватель может воспринять его, как несовместимый, и открыть лоток диска, или может воспроизвести диск, но неправильно. Сотрите мягкой тканью грязь с рабочей поверхности.

Очистка считывающей линзы

- Ни в коем случае не используйте имеющиеся в продаже очищающие диски. Использование этих дисков может привести к повреждению линзы.
- Для очистки линзы обратитесь в ближайший сервисный центр, официально рекомендованный компанией Yamaha.

■ Примечание по просмотру видеоизображений в формате 3D

- Некоторые люди могут испытывать дискомфорт (например, напряжение глаз, утомление или тошнота) при просмотре видеоизображений в формате 3D. Мы рекомендуем всем зрителям делать регулярные перерывы при просмотре видеоизображений в формате 3D.
- Если вы испытываете какой-либо дискомфорт, прекратите просмотр видеоизображений в формате 3D, пока дискомфортом не пройдет. При наличии значительных неприятных ощущений обратитесь к врачу.
- Внимательно прочтите соответствующие руководства (для диска Blu-ray или телевизора) и/или предупреждающие сообщения на экране телевизора.
- Зрение маленьких детей (особенно детей младше шести лет) находится в стадии развития. Проконсультируйтесь с врачом (с педиатром или окулистом), прежде чем разрешать маленьким детям просмотр видеоизображений в формате 3D.
- Взрослые должны следить за маленькими детьми, чтобы гарантировать соблюдение представленных выше рекомендаций.

■ Технология Cinavia

- Технология Cinavia является частью системы защиты содержимого, встроенной в проигрыватель дисков Blu-ray.

Примечание

- Проигрыватель дисков Blu-ray может отобразить следующие сообщения или приостановить вывод изображения или звука при попытке воспроизведения несанкционированной копии содержимого с технологией защиты Cinavia.

Сообщения отображаются только на английском языке.

Остановка воспроизведения. Воспроизводимое содержание охраняется технологией Cinavia® и не разрешено для воспроизведения на этом устройстве. За дополнительной информацией обращайтесь на веб-сайт <http://www.cinavia.com>. Код сообщения 1.

Аудиовыход временно приглушен. Не настраивайте громкость воспроизведения. Воспроизводимое содержание охраняется технологией Cinavia® и не разрешено для воспроизведения на этом устройстве. За дополнительной информацией обращайтесь на веб-сайт <http://www.cinavia.com>. Код сообщения 3.

Примечание о технологии Cinavia

В этом устройстве используется технология Cinavia, ограничивающая использование несанкционированных копий доступных в продаже фильмов, видеоматериалов и их звуковых дорожек. При обнаружении запрещенного использования несанкционированной копии на экране отобразится сообщение, и воспроизведение или копирование будет прервано. Для получения дополнительной информации о технологии Cinavia посетите веб-сайт Интерактивного информационного центра поддержки потребителей Cinavia по адресу <http://www.cinavia.com>. Чтобы запросить дополнительную информацию о технологии Cinavia по почте, отправьте почтовую карточку, указав на ней свой почтовый адрес, по адресу: Cinavia Consumer Information Center, P.O. Box 86851, San Diego, CA, 92138, США.

Органы управления и функции

■ Передняя панель

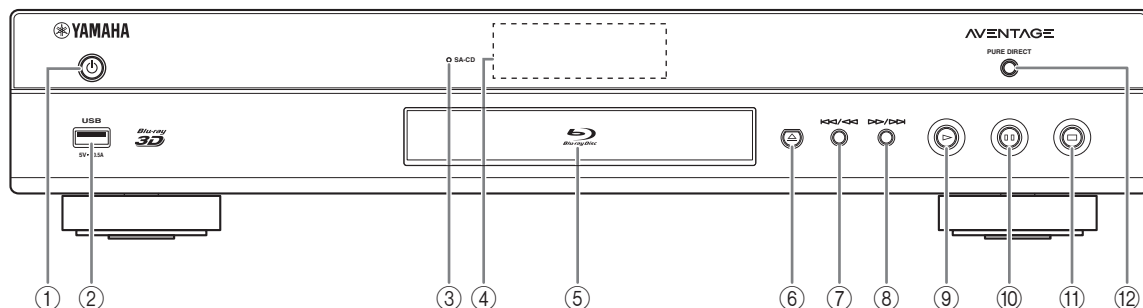

- ① **⏻ (Включение/Режим ожидания)**
Включение проигрывателя/перевод проигрывателя в режим ожидания. Нажмите и удерживайте кнопку  на лицевой панели в течение 5 секунд для сброса настроек проигрывателя (системный сброс).
- ② **Разъем USB (стр. 17)**
- ③ **Индикатор SA-CD**
Загорается, когда в проигрыватель загружается диск SA-CD и выбирается соответствующий слой SA-CD (стр. 4).
- ④ **Дисплей лицевой панели**
Отображает различную информацию и сведения о состоянии.
- ⑤ **Дверца лотка для дисков**
- ⑥ **▲ (Извлечь)**
Открытие/закрытие лотка для дисков.
- ⑦ **⏮/⏪ (Поиск назад/Пропуск назад)**
Нажмите для перехода к предыдущему фрагменту записи или удерживайте для поиска в обратном направлении.
- ⑧ **⏩/⏭ (Поиск вперед/Пропуск вперед)**
Нажмите для перехода к следующему фрагменту записи или удерживайте для поиска в прямом направлении.
- ⑨ **▶ (Воспроизведение)**
Запуск воспроизведения.
- ⑩ **■ ■ (Пауза)**
Приостановка воспроизведения.
- ⑪ **■ (Стоп)**
Остановка воспроизведения.
- ⑫ **PURE DIRECT**
Нажмите, чтобы изменить режим Pure Direct (стр. 10). Данная кнопка подсвечивается, когда режим Pure Direct включен.

Примечание

– Перед началом работы с проигрывателем снимите защитную пленку с лицевой панели.

■ Задняя панель

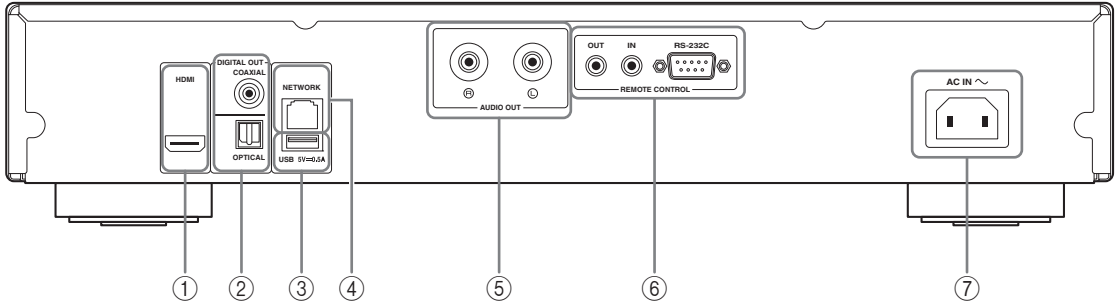

① HDMI (стр. 12)

② DIGITAL OUT (COAXIAL/OPTICAL) (стр. 14)

③ USB (стр. 17)

④ NETWORK (стр. 15)

⑤ AUDIO OUT (L/R) (стр. 14)

⑥ REMOTE CONTROL (OUT/IN/RS-232C)
(стр. 18)

⑦ AC IN (стр. 18)

Пульт дистанционного управления

Примечание

– Значок  отобразится в верхнем левом углу экрана при нажатии кнопки, которая недоступна.

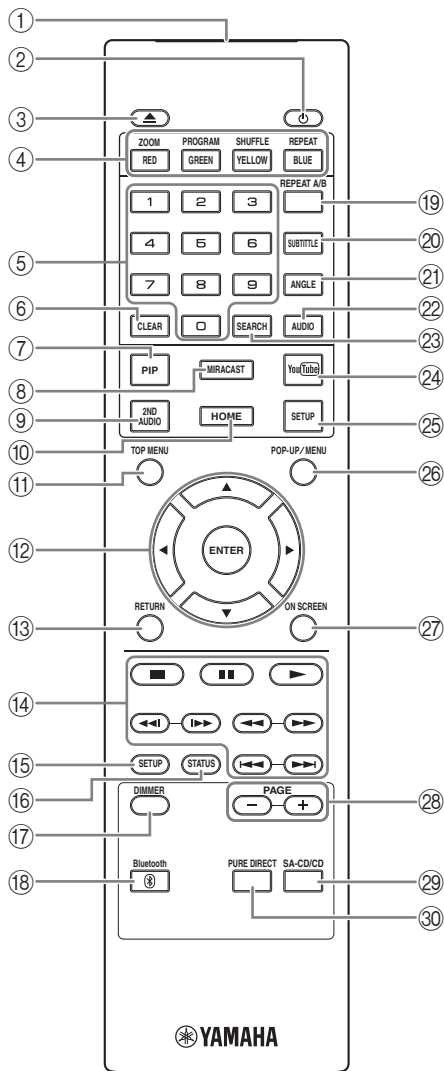

① **Передатчик инфракрасных сигналов:** отправляет инфракрасные сигналы. Наведите его на датчик дистанционного управления (стр. 11).

② : включение проигрывателя или перевод его в режим ожидания.

③ : открытие/закрытие лотка диска.

④ **Цветные кнопки [BD]:** используйте эти кнопки в соответствии с инструкциями на экране.

ZOOM [DVD VIDEO PHOTO]: увеличение или уменьшение. Размер экрана будет изменяться при каждом нажатии кнопки (увеличение/уменьшение: по 3 уровня для каждого).

PROGRAM [DVD CD]: установка порядка воспроизведения (стр. 29). Можно установить до 15 дорожек (для аудиодиска) или заголовков/ глав (DVD-Video).

SHUFFLE [DVD CD VIDEO MUSIC PHOTO]: выбор режима воспроизведения в случайном порядке (стр. 27).

REPEAT [BD DVD CD VIDEO MUSIC]

PHOTO: изменение режима повтора. Режимы повтора будут меняться при каждом нажатии кнопки, как показано далее.

: повтор воспроизводимого в данный момент заголовка.

: повтор воспроизводимой в данный момент главы.

: повтор воспроизводимой в данный момент папки.

: повтор всех треков/файлов на диске.

: повтор воспроизводимого в данный момент трека/файла.

⑤ **Цифровые кнопки:** ввод цифр, а также во время воспроизведения переход к треку/главе, которая соответствует введенному числу. Работа этих кнопок зависит от типа диска и состояния воспроизведения.

⑥ **CLEAR:** удаление введенного числа/ выбранного элемента.

⑦ **PIP [BD]:** включение/выключение функции “Картинка в картинке” (стр. 30). Если эта функция доступна, на экране отображается метка PIP (). Этот элемент можно также выбрать в экранном меню (стр. 27).

Примечание

– Метка PIP отображается, только если включен параметр “PIP метка” (стр. 35).





⑧ **MIRACAST:** запуск Miracast (стр. 26).

⑨ **2ND AUDIO** **BD**: выбор вторичного аудио для функции “Картинка в картинке” (стр. 30) или аудиокментариев. Если эта функция доступна, на экране отображается метка вторичного аудио () (стр. 38). Этот элемент можно также выбрать в экранном меню (стр. 27).

Примечание





– Метка вторичного аудио отображается, только если включен параметр “Метка вторичного аудио” (стр. 35).

⑩ **HOME**: отображение меню HOME (стр. 20).

⑪ **TOP MENU** **BD** **DVD**: отображение на экране главного меню, если оно имеется на диске. Выберите требуемый элемент с помощью кнопок /// и **ENTER**.

Примечание

– В зависимости от диска некоторые операции могут отличаться. Следуйте указаниям на экранах меню.

⑫ **Кнопки управления курсором** (///): перемещение по экрану меню.

ENTER: выбор выделенного меню/элемента.

⑬ **RETURN**: возврат к предыдущему меню, экрану и т.д.

⑭ **Кнопки управления**

BD **DVD** **CD** **VIDEO** **MUSIC** **PHOTO**

: остановка воспроизведения.

: приостановка воспроизведения.

: воспроизведение содержимого.

/: пропуск назад/вперед.

/

BD **DVD** **CD** **VIDEO** **MUSIC**:

поиск назад/вперед. Скорость поиска будет меняться при каждом нажатии кнопки (поиск назад/поиск вперед: по 5 уровней для каждого). Нажмите  для возобновления обычного воспроизведения.

PHOTO: изменение скорости слайд-шоу (медленнее/быстрее: 3 уровня).

/

BD **DVD** **CD** **VIDEO** **MUSIC**:

нажмите для осуществления мгновенного поиска/повтора. Мгновенный поиск осуществляет переход по содержимому на 30 секунд. Мгновенный повтор осуществляет повторное воспроизведение содержимого, начиная с точки за 10 секунд до данного момента.

⑮ **SETUP**: отображение экрана меню УСТАНОВКИ (стр. 31).

⑯ **STATUS**: отображение информации о воспроизведении (стр. 28).

⑰ **DIMMER**: изменение яркости дисплея передней панели в диапазоне 4 уровней.

⑱ **Bluetooth**: запуск *Bluetooth* (стр. 24).

⑲ **REPEAT A/B** **BD** **DVD** **CD** **VIDEO** **MUSIC**: воспроизведение определенного отрывка, который нужно повторить.

1 Нажмите **REPEAT A/B** при просмотре момента, в котором требуется установить точку начала. На экране отобразится значок “A-”.

2 Нажмите **REPEAT A/B** еще раз при просмотре момента, в котором требуется установить точку окончания. На экране отобразится значок “A-B”. Начнется повторное воспроизведение.

3 Чтобы отменить повторное воспроизведение, нажмите **REPEAT A/B**. Значок “A-B” исчезнет, и повторное воспроизведение будет завершено.

Примечание

– Эту функцию, возможно, не удастся выполнить в зависимости от параметров диска.

⑳ **SUBTITLE** **BD** **DVD** **VIDEO**: изменение языка субтитров (стр. 48) (при наличии). Этот элемент можно также выбрать в экранном меню (стр. 27).

㉑ **ANGLE** **BD** **DVD**: изменение угла камеры, если видео записано с разными углами зрения. Если эта функция доступна, на экране отображается метка угла () (стр. 27). Этот элемент можно также выбрать в экранном меню (стр. 27).

Примечание

– Метка угла отображается, только если включен параметр “Угловая метка” (стр. 35).

㉒ **AUDIO** **BD** **DVD** **VIDEO**: изменение языка или формата аудиосигнала. Этот элемент можно также выбрать в экранном меню (стр. 27).

㉓ **SEARCH** **BD** **DVD** **CD** **VIDEO** **MUSIC**: быстрый переход к указанной точке во время воспроизведения. Для получения дополнительной информации об этой функции см. раздел “Использование поиска” (стр. 29). Этот элемент можно также выбрать в меню состояния (стр. 28).

㉔ **YouTube**: запуск YouTube (стр. 23).

㉕ **SETUP**: отображение экрана меню SETUP (стр. 31).

Продолжение на следующей странице. →

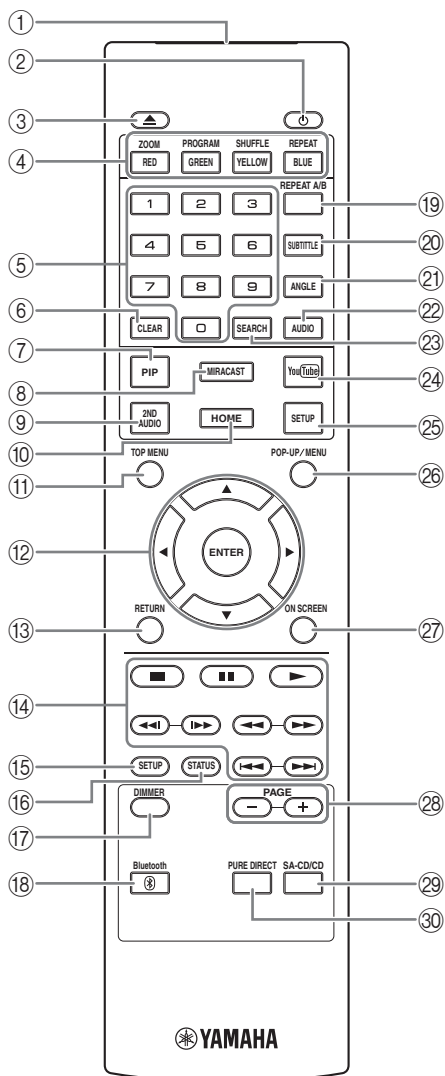

26 **POP-UP/MENU** [BD] [DVD]: отображение всплывающего меню. Содержание появившегося меню изменяется в зависимости от диска. Для получения дополнительной информации об управлении всплывающим меню обратитесь к руководству пользователя диска.

В зависимости от диска DVD, главное меню можно вывести на экран, нажав кнопку **POP-UP/MENU**.

27 **ON SCREEN:** отображение экранного меню (стр. 27).

28 **PAGE (+/-)** [DVD]: переход к предыдущей/следующей странице при воспроизведении диска DVD-Audio, включая функцию слайд-шоу и переворот страниц.

Примечание

– Возможность выполнения данной функции зависит от содержимого диска.

29 **SA-CD/CD:** выбор воспроизводимого слоя при использовании гибридных дисков SA-CD/CD (стр. 4).

Совет

– Индикатор SA-CD (стр. 6) на передней панели загорается, когда загружен диск SA-CD и выбран слой SA-CD.

Примечания

– Выполнение данной операции возможно только при отсутствии диска.
 – Если выбран слой SA-CD, аудиосигналы с гнезд цифрового выхода COAXIAL или OPTICAL не выводятся.

30 **PURE DIRECT:** переключение между следующими режимами Pure Direct.
Mode 1: включение режима Pure Direct с отключением дисплея передней панели и вывода видеосигналов HDMI. Данный режим подходит для прослушивания музыки с высоким качеством звука.

Mode 2: включение режима Pure Direct с отключением дисплея передней панели. Данный режим подходит для просмотра фильмов с высоким качеством звука.

Off: отключение режима Pure Direct.

Совет

– Кнопка PURE DIRECT (стр. 6) на передней панели подсвечивается, когда режим Pure Direct включен.

Установка батарей в пульт дистанционного управления

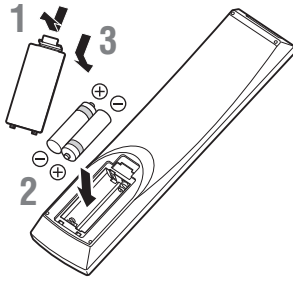

Примечания

- В случае уменьшения рабочего диапазона пульта дистанционного управления замените обе батарейки.
- Используйте батареи типа AAA, R03, UM-4.
- При установке батареек соблюдайте полярность. См. изображение внутри отсека для батареек.
- Извлеките батарейки, если пульт дистанционного управления не будет использоваться в течение длительного периода времени.
- Не используйте старые батарейки вместе с новыми.
- Не используйте вместе батарейки разного типа (например, щелочные и марганцевые). Внимательно прочитайте информацию на упаковке, так как батарейки разного типа могут иметь одинаковую форму и цвет.
- Если батарейка начала протекать, незамедлительно утилизируйте ее. Не прикасайтесь к вытекшему электролиту и не допускайте его попадания на одежду и т.п. Перед установкой новых батареек тщательно очистите отсек для батареек.
- Не выбрасывайте батарейки вместе с бытовыми отходами. Утилизируйте их в соответствии с местным законодательством.
- Не давайте батарейки детям. Если ребенок случайно проглотил батарейку, незамедлительно обратитесь к врачу.
- Если пульт дистанционного управления не будет использоваться в течение длительного времени, извлеките из него батарейки.
- Не заряжайте и не разбирайте прилагаемые батарейки.

Приблизительный диапазон работы пульта дистанционного управления

Датчик дистанционного управления

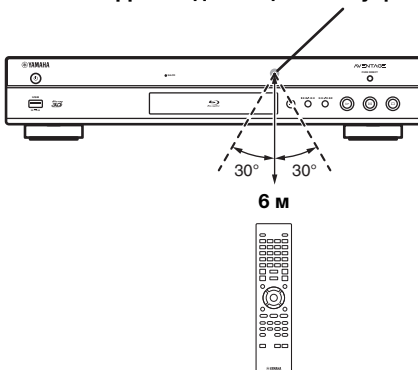

Функция идентификации

При использовании изделий Yamaha пульт дистанционного управления может работать с другими изделиями Yamaha или другой пульт дистанционного управления может работать с данным проигрывателем. В данном случае во избежание нарушений в работе можно изменить идентификатор пульта дистанционного управления. Если вы изменили идентификатор пульта дистанционного управления, то необходимо установить тот же самый идентификатор и на основном устройстве. Стандартное значение ID1.

1 Настройка пульта ДУ

Для изменения значения идентификатора с ID1 на ID2 нажмите и удерживайте красную кнопку и **2** цифровых кнопки одновременно 7 секунд. Для изменения значения идентификатора с ID2 на ID1 нажмите и удерживайте красную кнопку и **1** цифровых кнопки одновременно 7 секунд.

2 Настройка основного блока

Одновременно нажмите и удерживайте **◀◀/◀** и **▶▶/▶** на лицевой панели в течение 2 секунд, чтобы отобразить текущий идентификатор в следующих случаях.

- В проигрывателе нет диска.
- Лоток диска закрыт.
- Воспроизведение остановлено.
- На дисплее передней панели отображается надпись "NO DISC".

Продолжайте нажимать и удерживать кнопки еще 2 секунды для изменения значения идентификационного кода между ID1 или ID2.

Примечания

- Если пульт ДУ находился без батарей несколько минут, или находящиеся в нем батареи полностью разряжены, идентификатор пульта автоматически устанавливается в значение ID1. Если необходимо установить идентификатор дистанционного управления в значение ID2, следует поменять батареи в пульте, и затем снова установить идентификатор.
- После сброса настроек проигрывателя для идентификатора пульта дистанционного управления будет установлено значение ID1.

Подключение аудио/видео

Выполните подключение соответствующих аудио/видео кабелей в зависимости от используемого оборудования.

Советы

- См. стр. 40 для получения информации о форматах аудио/видео для вывода.
- Подготовьте продаваемые отдельно кабели, необходимые для подключения. Тип и количество необходимых кабелей зависят от подключаемого оборудования.

Воспроизведение аудио/видео с использованием телевизора и аудио/видео ресивера

См. раздел “Подключение к телевизору через аудио/видео ресивер” (стр. 13).

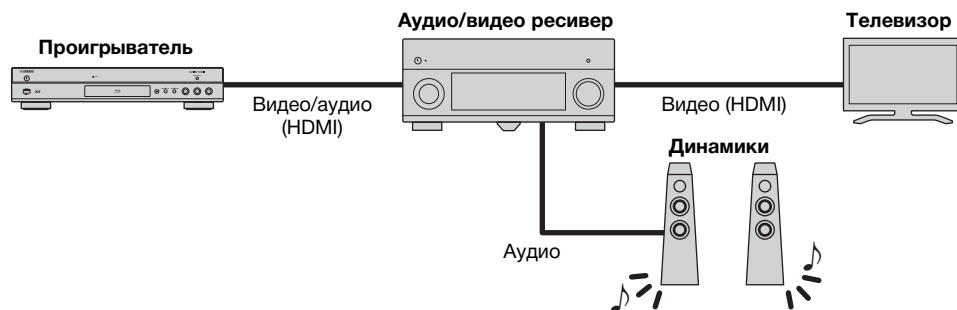

Воспроизведение аудио/видео с использованием только телевизора

См. раздел “Подключение к телевизору напрямую” (стр. 13).

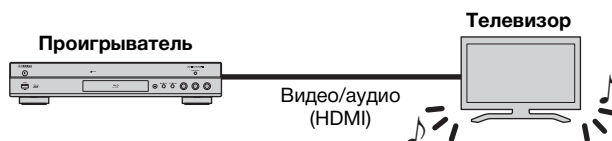

Воспроизведение аудио/видео с использованием телевизора и аудиоборудования

См. раздел “Подключение к телевизору и аудиоборудованию” (стр. 14).

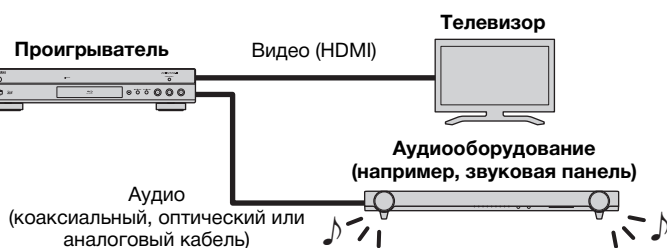

О HDMI

Для получения высококачественного изображения и звука посредством разъема HDMI используйте продаваемые отдельно кабели HDMI типа HIGH SPEED с логотипом HDMI (как указано на последней странице обложки).

Советы

- Для получения информации о функции контроля HDMI см. раздел “HDMI контроль” (стр. 34).
- Для изменения режима вывода разъема HDMI выполните настройку “HDMI” (стр. 38) в Настройка звука.

Подключение для воспроизведения дисков Blu-ray 3D

Для воспроизведения на данном проигрывателе дисков Blu-ray 3D система должна удовлетворять следующим требованиям.

- Телевизор и аудио/видео ресивер (при наличии) должны поддерживать работу с 3D.
- 3D Выход в Настройка дисплея (стр. 37) установлено в значение “Авто”.

■ Подключение к телевизору через аудио/видео ресивер

С помощью кабелей HDMI подключите проигрыватель к аудио/видео ресиверу, а ресивер к телевизору.

Для получения дополнительной информации о подключении колонок см. руководство пользователя, поставляемое с аудио/видео ресивером и колонками.

Предупреждение!

Не подключайте кабель питания проигрывателя, пока не завершены все подключения.

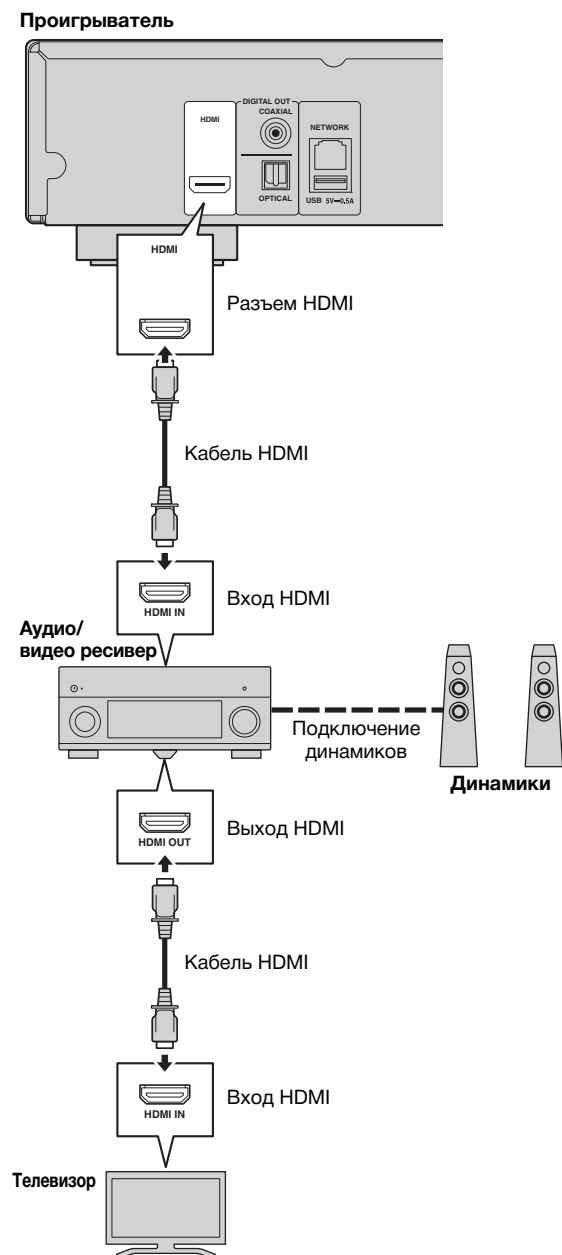

■ Подключение к телевизору напрямую

Подключите проигрыватель к телевизору с помощью кабеля HDMI.

Предупреждение!

Не подключайте кабель питания проигрывателя, пока не завершены все подключения.

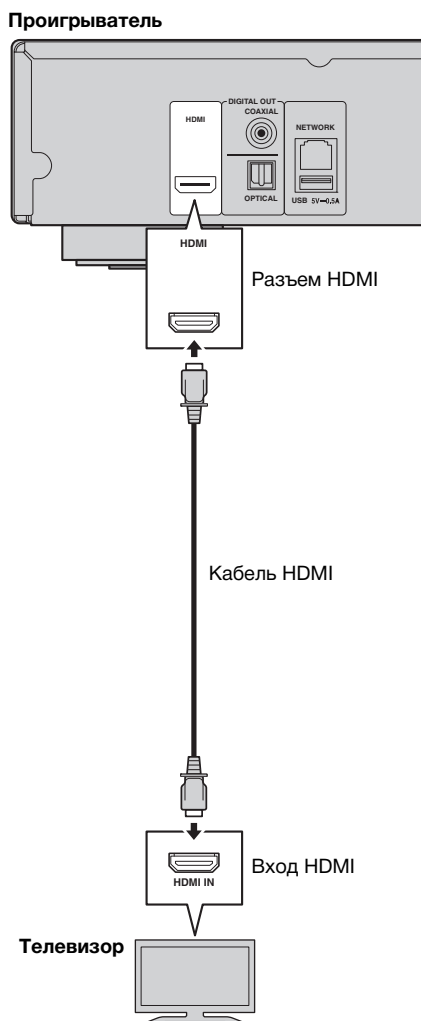

■ Подключение к телевизору и аудиооборудованию

Подключите проигрыватель к телевизору с помощью кабеля HDMI, а к аудиооборудованию с помощью аудиокабеля (цифровой оптический кабель, цифровой коаксиальный кабель или стереокабель).

Предупреждение!

Не подключайте кабель питания проигрывателя, пока не завершены все подключения.

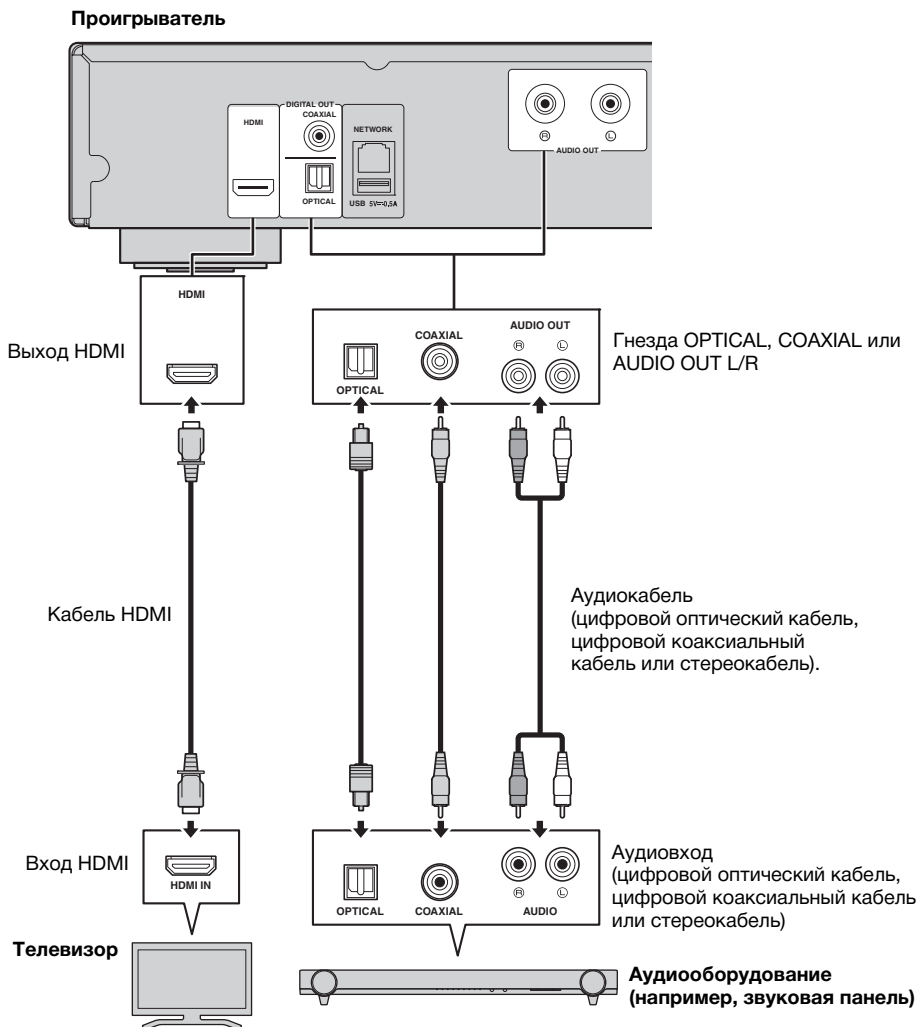

Советы

- Для изменения режима вывода для гнезд COAXIAL/OPTICAL выполните настройку для “Коаксиальный / Оптический” (стр. 38) в разделе “Настройка звука”.
- Если воспроизводимый аудиосигнал выводится одновременно из колонок телевизора и средствами аудиооборудования, в разделе “Настройка звука” установите для HDMI значение “Выкл.” для прекращения вывода звука через телевизор.
- Аудиосигналы с SACD не выводятся посредством гнезд COAXIAL и OPTICAL (стр. 41).

Сетевое подключение

Подключение проигрывателя к сети (беспроводное или проводное) позволяет использовать следующие функции.

- Воспроизведение содержимого сервера DLNA (ПК или сетевое хранилище данных) (стр. 20)
- Воспроизведение содержимого различных сетевых служб (стр. 22)
- Воспроизведение дисков с поддержкой BD-Live (стр. 29)
- Управление проигрывателем с мобильных устройств (AV CONTROLLER) (стр. 26)

Примечания

- Для использования сетевых служб или функции BD-Live требуется широкополосное подключение к сети Интернет.
- Обратитесь к руководству пользователя данного оборудования, так как подключаемое оборудование и метод подключения могут различаться в зависимости от имеющейся сетевой инфраструктуры.
- Используйте сетевой кабель/маршрутизатор, поддерживающий 10BASE-T/100BASE-TX.

Совет

- При использовании маршрутизатора с поддержкой DHCP нет необходимости выполнять в проигрывателе настройку параметров сети, поскольку параметры сети (такие как IP-адрес) будут назначены проигрывателю автоматически. Настройку параметров сети необходимо производить только в том случае, если маршрутизатор не поддерживает DHCP или требуется выполнить настройку параметров вручную (стр. 36).

■ Беспроводное соединение

Используя реализованную в проигрывателе технологию Wi-Fi можно подключить проигрыватель к сети (маршрутизатору) посредством беспроводного соединения. Для использования Wi-Fi см. информацию в разделе “Настройка беспроводного соединения” (стр. 19) и настройте беспроводное соединение соответствующим образом.

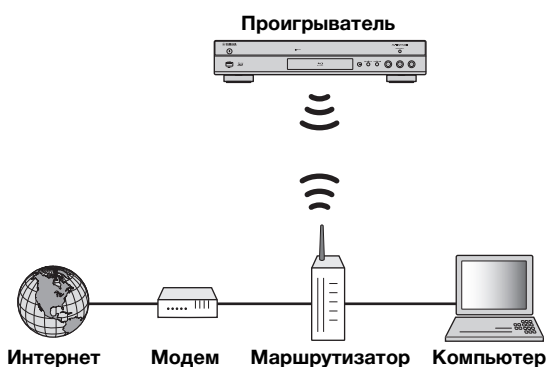

■ Проводное соединение

Подсоедините проигрыватель к сети (маршрутизатору) посредством продаваемого отдельно экранированного сетевого кабеля типа “витая пара” (STP).

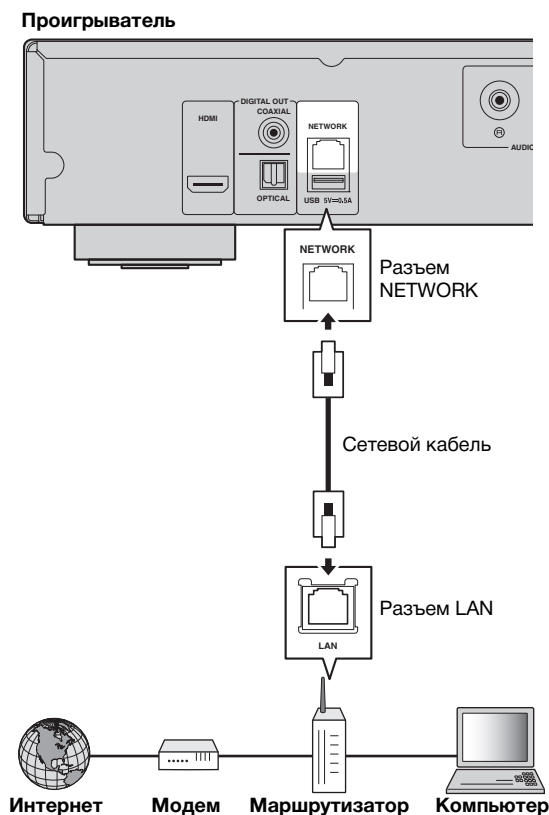

■ Настройка сервера DLNA

Использование DLNA обеспечивает совместный доступ к мультимедийному содержимому (видеофайлам, музыке и фотографиям), хранящемуся на сервере DLNA (ПК или сетевое хранилище данных), подключенному к сети, и позволяет воспроизводить подобное содержимое с помощью проигрывателя. Помимо этого, пользователь может использовать мобильное устройство (например, смартфон или планшет) для управления проигрывателем по беспроводной сети.

Для использования возможностей DLNA необходимо после подключения к сети настроить сервер DLNA следующим образом (стр. 15).

Примечания

- Для использования возможностей DLNA все устройства должны быть подключены к одной сети.
- Для использования сетевого хранилища данных в качестве сервера DLNA сетевое хранилище данных должно поддерживать соответствующий функционал.



Настройка совместного использования медиасодержимого на сервере DLNA

Для воспроизведения мультимедийного содержимого, хранящегося на сервере DLNA (ПК или сетевое хранилище данных) необходимо предварительно настроить работу функции совместного использования медиасодержимого в программном обеспечении сервера DLNA.

Совет

- Информацию о настройке сервера DLNA и поддерживаемых сервером DLNA форматах файлов см. в руководствах пользователя сервера DLNA и соответствующего программного обеспечения.

- 1 Включите сервер DLNA (ПК или сетевое хранилище данных) и проигрыватель.
- 2 При использовании ПК в качестве сервера DLNA убедитесь, что на ПК установлено программное обеспечение сервера DLNA (например, Windows Media Player 12).

- 3 На сервере DLNA включите совместный доступ к медиасодержимому и разрешите совместный доступ к медиасодержимому для данного проигрывателя. Настройка сервера DLNA завершена. Для воспроизведения на данном проигрывателе содержимого сервера DLNA выберите сервер DLNA и файл мультимедиа в меню HOME (стр. 20).

Использование мобильного устройства в качестве мультимедийного пульта управления

При наличии мобильного устройства (например, телефона или планшета), поддерживающего функцию Digital Media Controller (DMC), можно управлять данным проигрывателем с такого телефона или планшета через сеть.

Советы

- Для того, чтобы разрешить управление проигрывателем с помощью мобильного устройства, задайте для параметра Контроль DMC (стр. 36) в меню УСТАНОВКИ значение Разрешать (значение по умолчанию).
- Для того, чтобы проверить, поддерживает ли мобильное устройство функцию DMC, обратитесь к руководствам пользователя мобильного устройства и соответствующего программного обеспечения.

USB-подключение

Для воспроизведения файлов мультимедиа, хранящихся на запоминающем устройстве USB, подключите запоминающее устройства USB к разъему USB на лицевой или задней панели проигрывателя (стр. 20).

Примечания

- Компания Yamaha не может гарантировать, что запоминающие устройства USB всех марок будут работать с данным проигрывателем.
- При использовании функции BD-Live подключите запоминающее устройство USB к одному из разъемов USB (лицевому/заднему) проигрывателя (стр. 30).

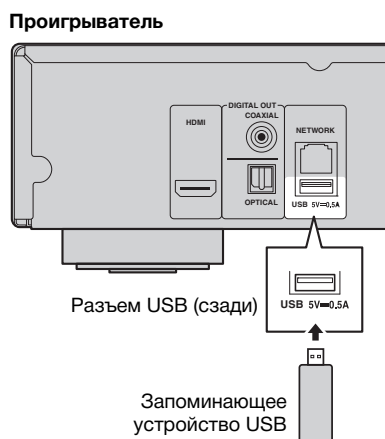
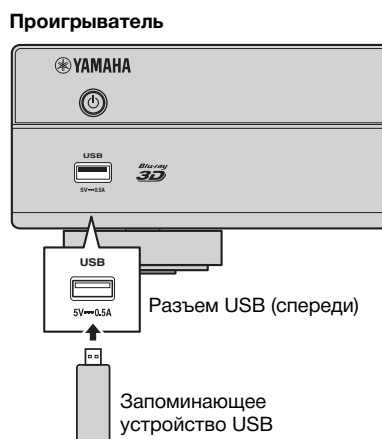

Другие подключения

■ Подключение к гнездам REMOTE CONTROL

- Подключившись к гнездам REMOTE CONTROL (OUT/IN), можно передавать и принимать сигналы дистанционного управления.
- Надежно подключите монофонические миникабели с разъемами 3,5 мм (продаются отдельно) к гнездам REMOTE CONTROL (OUT/IN).

Предупреждение!

Не подключайте кабель питания проигрывателя, пока не завершены все подключения.

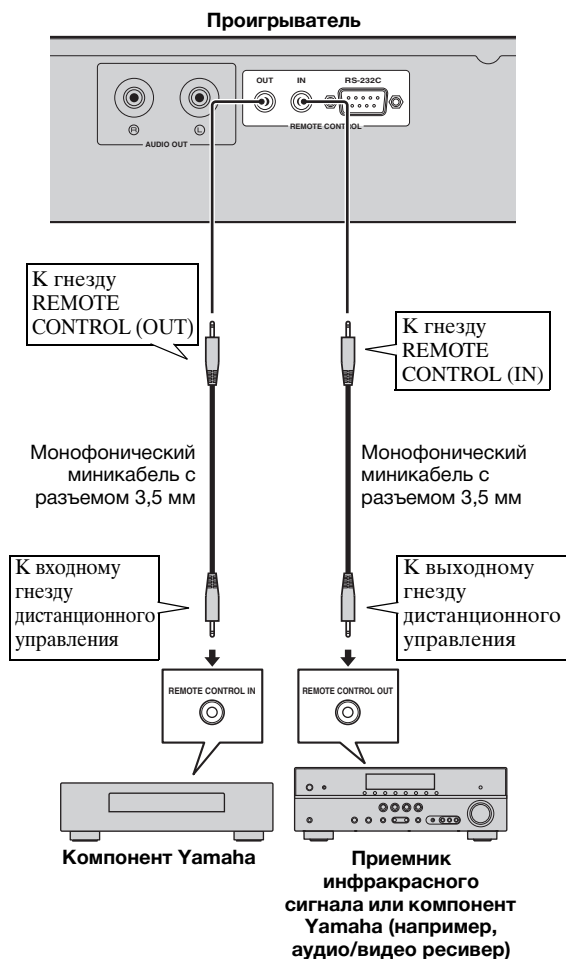

Советы

- Если используемый аудио/видео ресивер является продуктом компании Yamaha и поддерживает передачу сигналов управления SCENE с помощью гнезда REMOTE OUT, можно управлять проигрывателем с помощью функции SCENE. Для получения дополнительной информации о функции SCENE см. руководство пользователя, поставляемое с аудио/видео ресивером Yamaha.
- Можно подключить компонент Yamaha (например, проигрыватель CD), поддерживающий функцию SCENE, к гнезду REMOTE CONTROL (OUT) проигрывателя.
- Разъем RS-232C является управляющим разъемом расширения для коммерческого использования. Для получения дополнительной информации обратитесь к дилеру.

■ Подключение кабеля питания

- После выполнения всех подключений подсоедините прилагаемый кабель питания к входу AC IN на задней панели проигрывателя. Затем вставьте вилку в розетку переменного тока.

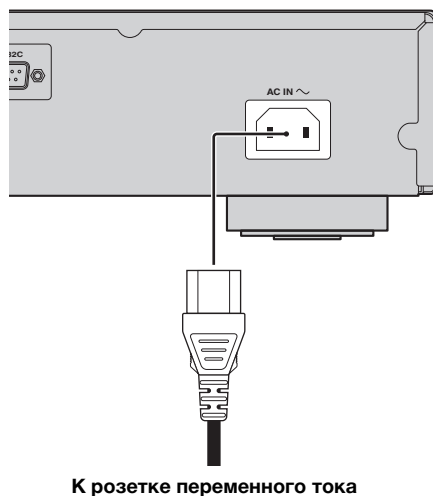

Начальные установки

■ Настройка с помощью функции простой установки

Функция простой установки позволяет без проблем указать язык, разрешение и соотношение сторон экрана. Экран Простая установка отображается при первом включении проигрывателя после покупки. Эти же настройки можно выполнить из меню УСТАНОВКИ → Система → Простая установка.

- 1 Когда отображается экран “Простая установка”, нажмите кнопку **ENTER**, чтобы запустить функцию “Простая установка”.

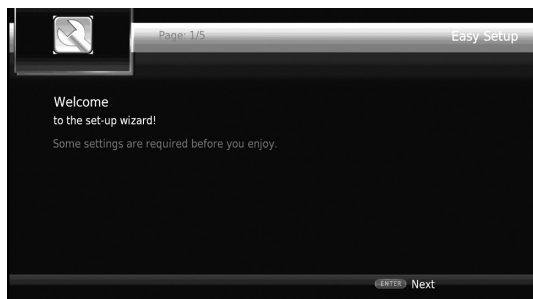

- 2 Настройте язык, разрешение и соотношение сторон экрана, следуя указаниям на экране.

Примечания

- Если после завершения работы функции “Простая установка” изображение не появилось, см. раздел “Устранение неисправностей” (стр. 44).
- При включении проигрывателя появится предупреждающее сообщение, касающееся воспроизведения видео в формате 3D. Нажмите **ENTER**, чтобы закрыть сообщение или **CLEAR**, чтобы отключить его (стр. 34).

■ Настройка беспроводного соединения

Для подключения данного проигрывателя к маршрутизатору по беспроводной сети выполните следующие действия по настройке беспроводного соединения.

Если маршрутизатор (точка доступа) поддерживает функцию WPS (Wi-Fi Protected Setup), для подключения проигрывателя к маршрутизатору можно воспользоваться функцией автонастройки без необходимости указывать информацию о сети (например, SSID) вручную.

- 1 Нажмите **SETUP** для отображения экрана меню УСТАНОВКИ.
- 2 Выберите Общие установки → Сеть → Тип соединения → Беспроводные.



- 3 Нажмите **◀▶** для выбора Да, а затем нажмите **ENTER**.



- 4 Нажмите **◀▶** для выбора одного из указанных методов настройки, а затем нажмите **ENTER**.



Поиск: выберите данный вариант для поиска имеющихся беспроводных сетей. После отображения списка сетей выберите SSID для подключения и введите пароль.

Вручную: выберите данный вариант для указания информации о сети (например, SSID) вручную.

Авто: выберите данный вариант для использования функции WPS. Выберите PBC (настройка нажатием кнопки) или метод ввода PIN-кода, а затем следуйте инструкциям на экране.

Примечания

- Подробную информацию об использовании маршрутизатора (точки доступа) можно найти в руководстве к соответствующему оборудованию.
- Если функция WPS не работает, выберите “Поиск” или “Вручную” для настройки параметров беспроводного соединения.
- Устройства, использующие частотный диапазон 2,4 ГГц, например микроволновая печь, устройство Bluetooth или цифровое беспроводное устройство, могут вызывать помехи для связи. Расположите проигрыватель вдали от таких устройств или выключите эти устройства.
- Скорость беспроводного соединения зависит от имеющегося сетевого окружения (типа маршрутизатора, расстояния от маршрутизатора до проигрывателя, мест установки оборудования и т. д.). Если при воспроизведении на время прерывается звук или пропадает изображение, переместите проигрыватель ближе к маршрутизатору или измените ориентацию проигрывателя или антенны маршрутизатора.

3

Воспроизведение

Русский

Меню HOME

Меню HOME позволяет использовать следующие основные функции проигрывателя.

- Выбор и воспроизведение мультимедийных файлов на различных дисках, запоминающих устройствах USB, серверах DLNA (ПК или система хранения данных)
- Доступ к различным сетевым службам (стр. 22)
- Отображение меню УСТАНОВКИ (стр. 31)

Советы

- Для получения дополнительной информации о типах дисков и форматах, которые можно воспроизвести, см. стр. 3
- Для воспроизведения содержимого сервера DLNA на проигрывателе необходимо выполнить настройку совместного доступа к медиасодержимому (стр. 16) на сервере DLNA.

■ Воспроизведение фотографий, музыки и видео

Основные операции

◀/▶/▲/▼: перемещение по экрану.

◀: переход в папку уровнем выше.

HOME: переход на экран/выход с экрана меню HOME.

ENTER: подтверждение выбора папки/файла.

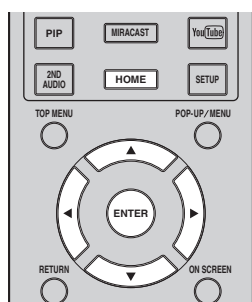

Основные операции для воспроизведения файлов в выбранной папке

Пример. Выбор файла фильма на запоминающем устройстве USB.

Примечание

- Перед тем, как перейти на экран меню HOME, остановите воспроизведение видео.

- 1 Нажмите кнопку **HOME** для отображения экрана меню HOME.

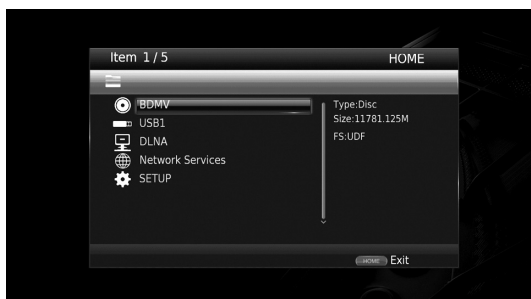

- 2 Нажмите ▲/▼ для выбора элемента, содержащего файл, который требуется воспроизвести, и нажмите **ENTER**.

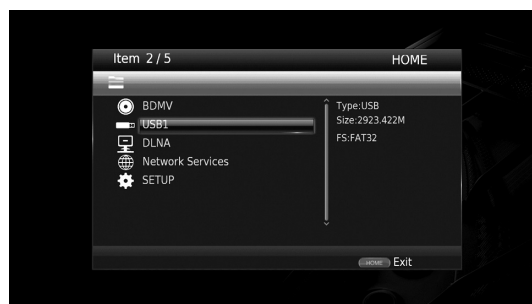

Примечание

- Если сервер DLNA отсутствует в списке, убедитесь, что он включен и выберите Поиск DLNA для обновления списка.

- 3 Выберите папку “Фото”, “Музыка”, “Видео” или AVCHD, которую требуется воспроизвести, и нажмите **ENTER**.

Чтобы вернуться в корневую папку, нажмите **RETURN** или выберите значок .



Примечание

– Обратите внимание, что в следующем шаге будет отображен только тип файлов, выбранный в этом шаге. Например, если в этом шаге выбрать папку “Фото”, то в следующем шаге будут отображены только файлы фотографий.

4 Выберите папку, содержащую файл, который требуется воспроизвести.



5 Выберите файл, который требуется воспроизвести, и нажмите **ENTER**.
 При выборе видеофайла начнется воспроизведение.
 При выборе музыкального файла отобразится экран состояния и начнется воспроизведение.
 При выборе файла фотографии начнется слайд-шоу.

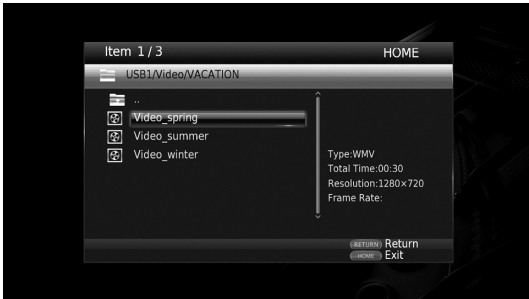

Совет

– Чтобы просматривать слайд-шоу с музыкой, нажмите **HOME** для возврата на экран меню HOME во время воспроизведения музыки и выберите файл фотографии.

Примечание

– Отображаемый файл, возможно, не удастся воспроизвести в зависимости от содержимого.

Операции для просмотра фотографий

Во время просмотра фотографий кнопки на пульте дистанционного управления работают следующим образом.

- : Остановка слайд-шоу и возврат к диспетчеру файлов.
- ■: Приостановка слайд-шоу.
- ▶: Воспроизведение слайд-шоу.
- ▶▶: Переход к следующей фотографии.
- ◀◀: Переход к предыдущей фотографии.
- ▶▶▶: Увеличение скорости слайд-шоу в диапазоне 3 уровней.
- ◀◀◀: Уменьшение скорости слайд-шоу в диапазоне 3 уровней.
- ▲: инвертирование фотографии.
- ▼: отражение фотографии по горизонтали.
- ◀: поворот фотографии против часовой стрелки.
- ▶: поворот фотографии по часовой стрелке.
- ▶ ZOOM: увеличение/уменьшение фотографии (по 3 уровня в каждую из сторон).
- ▲/▼/◀/▶: панорамирование в режиме масштабирования для отображения фотографии, размер которой больше размера экрана.

Использование сетевых служб

Данный проигрыватель поддерживает воспроизведение мультимедийного содержимого (фотографий и видеофайлов) с использованием следующих сетевых служб.

- Dropbox
- Веб-альбомы Picasa
- YouTube

Примечания

- Для доступа к содержимому, предоставляемому третьими сторонами, требуется высокоскоростное подключение к Интернету, а также может потребоваться регистрация учетной записи и платной подписки.
- Услуги третьих сторон по предоставлению содержимого могут быть изменены, приостановлены, прерваны или прекращены в любое время без уведомления, при этом компания Yamaha снимает с себя какую-либо ответственность, связанную с подобными случаями.
- Некоторые виды содержимого могут быть доступны только для конкретных стран и могут быть представлены на определенных языках.
- Компания Yamaha не предоставляет и не гарантирует продолжение оказания или доступности услуг по предоставлению содержимого в течение конкретного периода времени, и любые подобные гарантии, явные или подразумеваемые, не признаются.

1 Нажмите кнопку **HOME** для отображения экрана меню HOME.

Совет

- Для возврата на экран меню YouTube нажмите **YouTube**.

2 С помощью кнопок **▲/▼** выберите раздел сетевых служб, а затем нажмите **ENTER**.

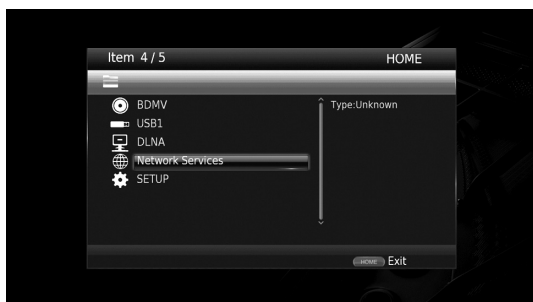

3 Нажмите **◀/▶/▲/▼** для выбора соответствующей сетевой службы, а затем нажмите **ENTER**.

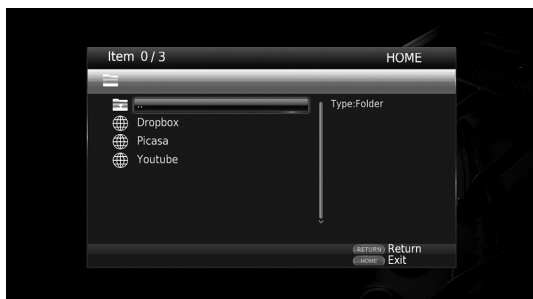

4 Нажмите **◀/▶/▲/▼** для выбора элемента, а затем нажмите **ENTER** для подтверждения выбора (или начала воспроизведения).

Совет

- Для выхода из режима работы с определенной сетевой службой нажмите **HOME**.

Примечание

- Действия, которые необходимо выполнить после шага 4 различаются в зависимости от элементов меню, предоставляемых каждой службой.

■ О Dropbox™

Dropbox представляет собой сетевую службу, позволяющую помещать имеющиеся файлы в Dropbox и получать к ним доступ с компьютеров, смартфонов или планшетов. Автоматически добавляйте фотографии и смешные видеотрекеры из любой точки земного шара. Дополнительную информацию можно получить на веб-сайте www.dropbox.com



Dropbox является товарным знаком компании Dropbox Inc.

■ О веб-альбомах Picasa™

Веб-альбомы Picasa представляют собой сетевую службу, позволяющую пользователям делиться фотографиями с друзьями и семьей, а также просматривать фотографии, выложенные в публичный доступ. Дополнительную информацию можно получить на веб-сайте picasaweb.google.com



“Picasa” и логотип “Picasa” являются торговыми марками компании Google. Inc.

■ О YouTube™

YouTube представляет собой сетевую службу, позволяющую пользователям искать, просматривать и делиться с другими пользователями собственными видеотреккерами посредством сети Интернет. Дополнительную информацию можно получить на веб-сайте www.youtube.com



“YouTube” и логотип “YouTube” являются торговыми марками компании Google. Inc.

Воспроизведение музыки через *Bluetooth*[®]

С помощью данного проигрывателя можно воспроизводить музыку на устройстве *Bluetooth* (смартфон и т.д.).

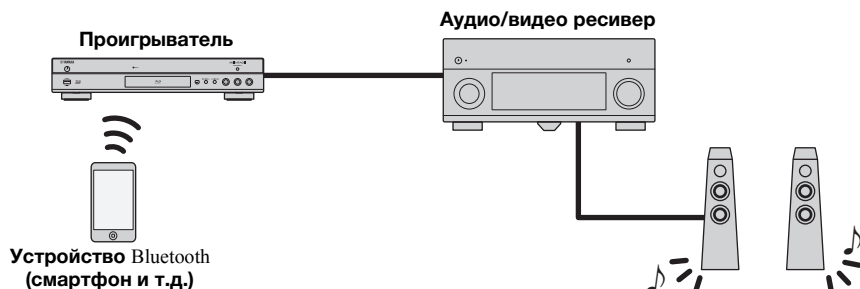

Советы

- “Сопряжение” необходимо для каждого используемого устройства *Bluetooth*.
- Используйте устройство *Bluetooth* на расстоянии не более 10 метров от данного проигрывателя.
- См. также руководство пользователя по устройству *Bluetooth*.

Bluetooth

– *Bluetooth* – это технология беспроводной связи между устройствами на расстоянии не более 10 метров, использующая частотный диапазон 2,4 ГГц, диапазон, который может использоваться без лицензии.

Управление соединениями Bluetooth

- Диапазон 2,4 ГГц, используемый *Bluetooth*-совместимыми устройствами, является радиодиапазоном, который совместно используется многими типами оборудования. Несмотря на то, что *Bluetooth*-совместимые устройства используют технологию, минимизирующую влияние других компонентов, использующих тот же радиодиапазон, такое влияние может сократить скорость или расстояние передачи данных, а в некоторых случаях препятствовать работе беспроводного соединения.
- Скорость передачи сигнала и расстояние, на котором возможно установить соединение, отличаются в зависимости от расстояния между соединяемыми устройствами, наличия препятствий, условий приема радиоволн и типа оборудования.
- Компания Yamaha не гарантирует наличие всех беспроводных соединений между данным аппаратом и устройствами, совместимыми с функцией *Bluetooth*.

■ Сопряжение устройства Bluetooth с данным проигрывателем

При установке соединения между устройством *Bluetooth* и данным проигрывателем в первый раз следуйте описанной ниже процедуре, чтобы выполнить “сопряжение”.

Примечания

- С данным проигрывателем может быть сопряжено до восьми устройств *Bluetooth*. При сопряжении девятого устройства информация о самом давнем сопряжении будет удалена.
- Если какое-либо устройство *Bluetooth* уже подключено к данному проигрывателю, отключите соединение *Bluetooth* перед выполнением сопряжения с новым устройством.
- При использовании соединения *Bluetooth* вы не сможете управлять лотком для дисков или воспроизведением других источников.

- 1 Если воспроизведение другого источника уже осуществляется, остановите воспроизведение.
- 2 Нажмите **Bluetooth**, чтобы выбрать *Bluetooth* в качестве источника входного сигнала.
- 3 Нажмите **RED**, чтобы переключить проигрыватель в режим сопряжения.
- 4 Включите устройство *Bluetooth*, с которым должен быть сопряжен проигрыватель, а затем выполните сопряжение. Подробнее о сопряжении см. руководство пользователя по устройству *Bluetooth*.
- 5 В списке устройств на вашем устройстве *Bluetooth* выберите “BD-A1040 Yamaha”. Если требуется ключ доступа (PIN-код), введите число “0000”.

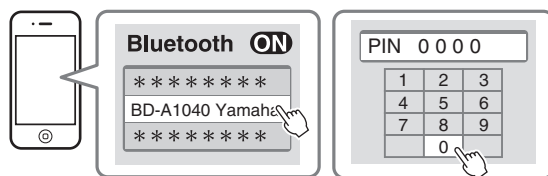

После успешного завершения сопряжения на дисплее передней панели появится надпись “SUCCESS” (на экране телевизора появится надпись Pairing Success).

При неудачном сопряжении на дисплее передней панели появится надпись “FAILED” (на экране телевизора появится надпись “Pairing Failed”).

■ Воспроизведение содержимого устройства Bluetooth

Примечания

- Если какое-либо устройство *Bluetooth* уже подключено к данному проигрывателю, отключите соединение *Bluetooth* перед подключением другого устройства *Bluetooth*.
 - При использовании соединения *Bluetooth* вы не сможете управлять лотком для дисков или воспроизведением других источников.
- 1 Если воспроизведение другого источника уже осуществляется, остановите воспроизведение.
 - 2 Нажмите **Bluetooth**, чтобы выбрать *Bluetooth* в качестве источника входного сигнала, а затем включите устройство *Bluetooth*.
Будет установлено соединение между устройством *Bluetooth* и данным проигрывателем.
 - 3 На устройстве *Bluetooth* запустите воспроизведение желаемого содержимого. При необходимости отрегулируйте уровень громкости устройства *Bluetooth*.
 - 4 Для отключения соединения *Bluetooth* нажмите **Bluetooth**.

Советы

- Соединение *Bluetooth* можно также отключить, нажав **HOME** или **RETURN**.
- Если соединение между устройством *Bluetooth* и данным проигрывателем не может быть установлено, выберите “BD-A1040 Yamaha” в списке устройств на вашем устройстве *Bluetooth*.
- Соединение *Bluetooth* отключится автоматически при выключении устройства *Bluetooth* или данного проигрывателя.

Воспроизведение фотографий и видеофрагментов со смартфона на экране телевизора (Miracast™)

Miracast представляет собой технологию, позволяющую беспрепятственно воспроизводить видео на различных устройствах без необходимости использования кабелей или установления сетевого подключения посредством точки доступа (Wi-Fi Direct). Данная технология позволяет, например, просматривать фотографии с поддерживающих Miracast устройств (смартфон и т. д.) на экране подключенного к плееру телевизора.

Примечания

- Для получения информации о поддержке определенным устройством технологии Miracast обратитесь к руководству пользователя соответствующего устройства.
- Когда на проигрывателе включена технология Miracast, другие сетевые функции (такие как DLNA) недоступны.
- При использовании технологии Miracast вы не сможете управлять лотком для дисков или воспроизведением других источников.

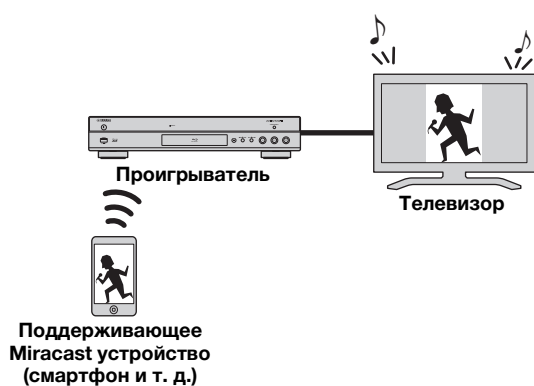

- 1 Если воспроизведение другого источника уже осуществляется, остановите воспроизведение.
- 2 Нажмите **MIRACAST**.
- 3 В течение 60 секунд используйте свой смартфон, чтобы включить функцию Miracast, и выберите данный проигрыватель в качестве подключаемого устройства. Подробнее о выполнении действий на смартфоне см. руководство пользователя по нему.
- 4 Для выхода из режима Miracast нажмите кнопку **MIRACAST**.

Совет

- Для завершения работы с Miracast можно также нажать кнопку **HOME** или **RETURN**.

В зависимости от окружения аудио/видео может прерываться или на экране телевизора может возникать шум. В этом случае попробуйте выполнить следующие действия.

- Переместите устройство с поддержкой Miracast ближе к проигрывателю.
- Отключите неиспользуемые устройства, поддерживающие беспроводную связь.
- Переместите устройство с поддержкой Miracast и проигрыватель подальше от микроволновых печей, устройств *Bluetooth* и других устройств, поддерживающих беспроводную связь.

Управление проигрывателем с мобильных устройств (AV CONTROLLER)

Использование приложения “AV CONTROLLER” на мобильном устройстве позволяет использовать данное устройство в качестве пульта управления проигрывателем.



AV CONTROLLER

- Данное приложение позволяет управлять основными функциями проигрывателей Yamaha Blu-ray Disc™, такими как воспроизведение, приостановка воспроизведения, пропуск фрагмента, выключение/выключение питания и перемещение курсора.
- Приложение “AV CONTROLLER” поддерживает множество языков.
- Для получения дополнительной информации о приложении “AV CONTROLLER” посетите веб-сайт Yamaha.

Расширенные операции воспроизведения

В данной главе описывается процесс воспроизведения приобретаемых отдельно дисков Blu-ray, DVD, SA-CD, CD, а также записанных дисков DVD-RW/R.

Примечание

- Описание основных операций воспроизведения см. на стр. 8

■ Экранное меню

Для отображения экранного меню нажмите **ON SCREEN**. Потом нажмите **▲/▼/◀/▶** для выбора пункта, а затем нажмите **ENTER** для выполнения соответствующей функции.

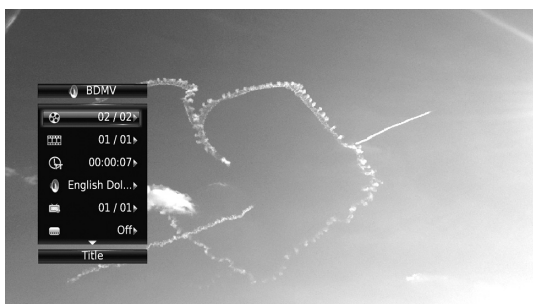

В экранном меню содержатся следующие пункты.

Заголовок [BD] [DVD] [VIDEO]: отображение номера заголовка, воспроизводимого в данный момент. Можно пропустить требуемый заголовок, выбрав его в этом пункте.

Глава [BD] [DVD] [VIDEO]: отображение номера главы, воспроизводимой в данный момент. Можно пропустить требуемую главу, выбрав ее в этом пункте.

Трек/Файл [CD] [VIDEO] [MUSIC] [PHOTO]: отображение номера трека/файла, воспроизводимого в данный момент. Можно пропустить требуемый трек/файл, выбрав его в этом пункте.

Время [BD] [DVD] [CD] [VIDEO] [MUSIC]: отображение времени воспроизведения. Выберите подходящий тип отображения:

- Прошедшее время воспроизведения заголовка, главы, трека или файла
- Оставшееся время воспроизведения заголовка, главы, трека или файла

Режим/Режим воспроизведения

[DVD] [CD] [VIDEO] [MUSIC] [PHOTO]: отображение текущего режима воспроизведения. Можно выбрать один из следующих режимов воспроизведения:

CD

- Нормальный: обычное воспроизведение.
- Перемешать: воспроизведение в случайном порядке без повтора.
- Случайный: воспроизведение в случайном порядке с повтором.

DVD

- Нормальный
- Перемешать главы (глава)
- Перемешать заголовки (заголовок)
- Перемешать все
- Случайные CH (глава)
- Случайные TT (заголовок)
- Случайные Все

VIDEO MUSIC PHOTO

- Нормальный
- Перемешать F (папка)
- Случайный F (папка)

Аудио [BD] [DVD] [VIDEO]: отображение выбранного в настоящий момент языка/ аудиосигнала диска Blu-ray/DVD. Возможен выбор нужного типа аудио.

Угол [BD] [DVD]: отображение выбранного в данный момент угла зрения. При наличии записи с несколькими углами зрения можно изменить угол зрения.

Субтитры [BD] [DVD] [VIDEO]: отображение выбранного в данный момент языка субтитров, если таковые имеются.

Стиль субтитров [BD]: отображение выбранного в данный момент стиля субтитров. Эту функцию можно использовать только для внешних субтитров видеофайла. Можно выбрать требуемый стиль текста субтитров.

Битрейт [BD] [DVD] [CD] [VIDEO] [MUSIC]: отображение скорости передачи данных аудио/ видеосигнала.

Вторичное видео [BD]: включение/отключение функции PIP (стр. 8).

Вторичное аудио [BD]: включение/отключение вторичного аудио (стр. 9).

Мгновенный Поиск

[BD] [DVD] [CD] [VIDEO] [MUSIC]: пропуск 30 секунд.

Мгновенный Повтор

[BD] [DVD] [CD] [VIDEO] [MUSIC]: повторное воспроизведение содержимого, начиная с точки за 10 секунд до данного момента.

Субтитры

[BD] [DVD] [VIDEO]: определяет отображаемые скрытые субтитры.

Слайд-шоу [PHOTO]

отображение скорости слайд-шоу. Можно выбрать следующие значения скорости слайд-шоу: Медленно/Средний/Быстро.

Перемещение [PHOTO]: просмотр того, как фотография отображается на экране. Можно выбрать тип перемещения.

Code Page [VIDEO]: выбор кодировки символов субтитров, добавленных к видео DivX (стр. 47).

■ Меню состояния

Используется для отображения различных настроек: субтитры, установки угла зрения, а также номер заголовка/главы/трека, воспроизводимых в данный момент. Чтобы отобразить меню состояния, нажмите **STATUS**. В меню состояния содержатся следующие меню.

BD DVD VIDEO

Пример. Значки при воспроизведении диска Blu-ray

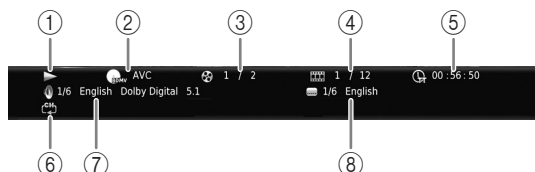

- ① **(Воспроизведение)**
- ② **(Значок типа диска/видеофайла)**
- ③ **(Номер воспроизводимого в данный момент заголовка):** для перехода к определенному заголовку нажмите кнопку **SEARCH** (стр. 9).
- ④ **(Номер воспроизводимой в данный момент главы) **BD DVD**:** для перехода к определенной главе нажмите кнопку **SEARCH** (стр. 9).
- ⑤ **(Номер трека/файла, воспроизводимого в данный момент) **VIDEO**:** для перехода к определенному треку нажмите кнопку **SEARCH** (стр. 9).
- ⑥ **(Прошедшее время воспроизведения):** для перехода к определенной точке нажмите кнопку **SEARCH** (стр. 9).
- ⑦ **(Режим повтора):** отображение текущего режима повтора (стр. 8).
- ⑧ **(Текущая аудиодорожка):** для изменения языка воспроизведения или формата воспроизведения нажмите кнопку **AUDIO**.
- ⑨ **(Текущие субтитры):** для изменения языка субтитров нажмите кнопку **SUBTITLE**.

DVD CD MUSIC

Пример. Значки при воспроизведении музыкального файла

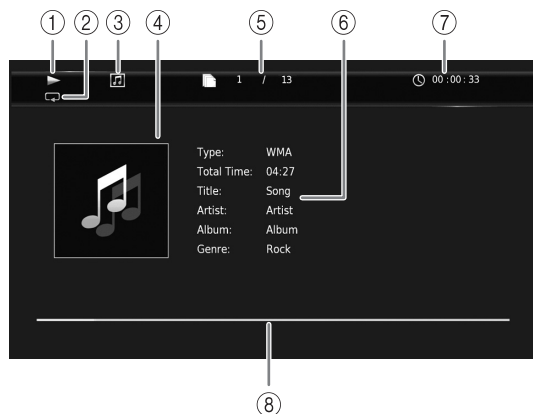

- ① **(Воспроизведение)**
- ② **(Режим повтора):** отображение текущего режима повтора (стр. 8).
- ③ **(Значок типа диска/музыкального файла)**
- ④ **(Изображение) **MUSIC**:** отображение рисунка, если он содержится в файле.
- ⑤ **(Номер трека/файла, воспроизводимого в данный момент):** для перехода к определенному треку нажмите кнопку **SEARCH** (стр. 9).
- ⑥ **(Информация) **MUSIC**:** отображение информации о музыкальной композиции, если она содержится в файле.
- ⑦ **(Прошедшее время воспроизведения):** для перехода к определенной точке нажмите кнопку **SEARCH** (стр. 9).
- ⑧ **(Полоса воспроизведения) **MUSIC**:** отображение состояния воспроизведения текущей композиции.

PHOTO

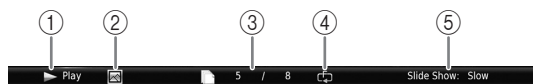

- ① **(Воспроизведение)**
- ② **(Значок файла фотографии)**
- ③ **(Номер отображаемого файла)**
- ④ **(Режим повтора):** отображение текущего режима повтора (стр. 8).
- ⑤ **(Скорость слайд-шоу)**

■ Программное воспроизведение **DVD** **CD**

Данная функция позволяет запрограммировать порядок воспроизведения треков аудиодисков или глав DVD.

Нажмите **PROGRAM** во время воспроизведения, чтобы отобразить окно ПРОГРАММА и запрограммировать порядок воспроизведения. Можно запрограммировать до 15 треков/глав.

Пример. Программирование порядка воспроизведения треков компакт-диска

- 1 Нажмите **PROGRAM** во время воспроизведения.



- 2 Нажмите **ENTER**, чтобы запрограммировать порядок воспроизведения. При воспроизведении аудиодиска выберите нужный трек с помощью кнопок **▲/▼**, а затем нажмите кнопку **ENTER**. При воспроизведении диска DVD-Video выберите требуемый заголовок (отображаются с пометкой **TT**) и главу (отображаются с пометкой **CH**) вместо трека. Чтобы удалить выбранный трек из программы, выберите трек, который требуется удалить, и нажмите **CLEAR**. Чтобы отменить программное воспроизведение, нажмите **RETURN**.



- 3 Завершив программирование, нажмите **▶**, чтобы установить и запустить программное воспроизведение.
- 4 Чтобы отменить программное воспроизведение, полностью остановите воспроизведение, нажав **■**.





■ Использование поиска

BD **DVD** **CD** **VIDEO** **MUSIC** **PHOTO**



Используется для быстрого перехода к указанной точке во время воспроизведения.

- 1 Нажмите **SEARCH** во время воспроизведения. Появится строка состояния.
- 2 Нажмите **▲/▼/◀/▶**, чтобы выбрать один из перечисленных элементов, затем нажмите **ENTER**.

BD **DVD** :

- Номер заголовка (отображаются с пометкой )
- Номер главы (отображаются с пометкой )
- Прошедшее время заголовка (отображаются с пометкой )
- Прошедшее время главы (отображаются с пометкой )

CD :

- Номер трека (отображаются с пометкой )
- Прошедшее время трека (отображаются с пометкой )
- Прошедшее время диска (отображаются с пометкой )

VIDEO **MUSIC** :





- Номер файла (отображаются с пометкой )
- Номер главы (отображаются с пометкой )
- Прошедшее время файла (отображаются с пометкой )

PHOTO :

- Номер файла (отображаются с пометкой )

- 3 С помощью кнопок **▲/▼** или цифровых кнопок установите или измените значение выбранного элемента и нажмите **ENTER**, чтобы перейти к указанной точке.
- 4 Чтобы скрыть строку состояния, нажмите **STATUS**.

■ Использование функций **BONUSVIEW™** и **BD-Live™**

Этот проигрыватель поддерживает функции воспроизведения **BONUSVIEW** (стр. 47) (**BD-ROM** профиль 1 версия 1.1) и **BD-Live** (стр. 47) (**BD-ROM** профиль 2).

Примечание

- Функции и способ воспроизведения могут отличаться в зависимости от диска. См. указания на диске или в прилагаемом руководстве пользователя.

■ Использование функции “Картинка в картинке” (воспроизведение вторичного видео/аудио)

BD-Видео, которое включает в себя функцию вторичного аудио/видео, совместимую с функцией Картинка в картинке, может одновременно воспроизводить вторичное аудио и видео в виде маленького видеокна в углу экрана.

Первичное видео Вторичное видео

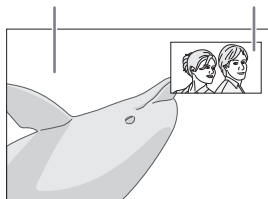

Если отображается метка PIP (PIP) или метка вторичного аудио (A2), нажмите кнопку PIP, чтобы включить или отключить функцию “Картинка в картинке”.

Примечания

- Для прослушивания вторичного аудио убедитесь, что для параметра Аудиовыход (Коаксиальный / Оптический или HDMI) установлено значение PCM или Перекодировать (стр. 38).
- В зависимости от диска для прослушивания вторичного аудио, возможно, потребуется включить вторичное аудио в главном меню диска (стр. 9).
- Вторичное аудио и видео для функции Картинка в картинке может автоматически появляться и исчезать в зависимости от содержимого. Кроме того, области воспроизведения могут быть ограничены.

■ Использование функции BD-Live™

1. Выполните настройки сети (стр. 36).

2. Подключите запоминающее устройство к проигрывателю (стр. 17).

Данные BD-Live будут сохранены на запоминающем устройстве, подключенном к проигрывателю. Для использования данных функций подсоедините запоминающее устройство USB, поддерживающее стандарт USB 2.0 High Speed (480 Мбит/с) к одному из разъемов USB (лицевой/задний) проигрывателя с целью использования данного запоминающего устройства в качестве Запоминающее устройство.

- Запоминающее устройство используется в качестве вспомогательной памяти при воспроизведении диска Blu-ray.

- Используйте запоминающее устройство USB с объемом свободного пространства не менее 2 Гб.
- При необходимости на запоминающем устройстве будет автоматически создана папка “BUDA”.
- Если на устройстве памяти будет недостаточно свободного места, данные не будут скопированы/загружены. Удалите ненужные данные или воспользуйтесь новым запоминающим устройством.
- Для загрузки данных (считывания/записи) может потребоваться некоторое время.

Примечания

- Компания Yamaha не может гарантировать, что запоминающие устройства USB всех марок будут работать с данным проигрывателем.
- Не используйте удлинительный кабель USB при подключении запоминающего устройства USB к разъему USB проигрывателя. Использование удлинительного кабеля USB может помешать правильной работе проигрывателя.

3. Воспроизведите диск.

4. Запустите BD-Live в соответствии с указаниями на диске.



Примечания

- Не извлекайте запоминающее устройство USB и не вынимайте кабель питания из проигрывателя во время использования функций BD-Live.
- Относительно сетевого способа воспроизведения содержимого BD-Live и т. д. выполняйте операции в соответствии с указаниями, приведенными в руководстве к диску Blu-ray.
- Чтобы использовать функции BD-Live, установите сетевое подключение (стр. 15) и выполните настройку сети (стр. 36).
- Для получения информации об установке ограничения доступа к содержимому BD-Live см. раздел “BD-Live соединения” (стр. 36).
- Время, необходимое для загрузки предоставляемых программ на запоминающее устройство USB, подсоединяемое к данному проигрывателю, зависит от скорости Интернет-соединения и объема данных соответствующих программ.
- Программы BD-Live могут сообщать об отсутствии подключения в зависимости от состояния (обновления) поставщика услуг. В таких случаях извлеките диск и попробуйте еще раз.
- Если экран BD-Live не отображается продолжительное время после выбора функции BD-Live в меню диска Blu-ray, возможно, на запоминающем устройстве USB недостаточно свободного места. В таких случаях извлеките диск из проигрывателя, а затем удалите данные с запоминающего устройства USB, используя меню “Форматировать” в меню “Запоминающее устройство” (стр. 34).

Меню УСТАНОВКИ

Меню УСТАНОВКИ позволяет выполнять различные аудиовизуальные установки и настройки функций с помощью пульта дистанционного управления.

Меню/подменю	Элемент	Функция	Стр.	
 Общие установки	Система			
	Авто режим ожид.	Включение или выключение функции энергосбережения.	34	
	HDMI контроль	Позволяет настроить проигрыватель для получения управляющего сигнала от пульта дистанционного управления телевизора или аудио/видео ресивера.	34	
	Загрузка исходных параметров	Сброс всех настроек к значениям по умолчанию, кроме настроек безопасности.	34	
	Обновление программного обеспечения	Выполнение обновления проигрывателя.	34	
	Обновление уведомлений	Возможность отображения сообщения на экране при обнаружении проигрывателем новой версии программного обеспечения в сети Интернет.	34	
	Сообщение о 3D воспроизведении	Отображение предупреждающего сообщения, касающегося воспроизведения видео в формате 3D, при включении проигрывателя.	34	
	Запоминающее устройство	Отображение количества свободного места на подключенном к проигрывателю запоминающем устройстве USB, а также форматирование папки "BUDA" на запоминающем устройстве.	34	
	Простая установка	Настройка языка, разрешения, соотношения сторон экрана.	34	
	Язык			
	Экранное меню	Выбор языка экранного меню.	34	
	Меню диска	Установка приоритетного языка для меню диска.	34	
	Аудио	Установка приоритетного языка для звучания.	34	
	Субтитры	Установка приоритетного языка для субтитров.	35	
	Воспроизведение			
	Автоматическое воспроизведение дисков	Проигрыватель будет автоматически запускать воспроизведение дисков.	35	
	Угловая метка	Позволяет включать и выключать режим Угловая метка при воспроизведении диска Blu-ray/DVD, записанного с разными углами зрения.	35	
	PIP метка	Позволяет включать и выключать отображение PIP метка при воспроизведении диска Blu-ray/DVD с функцией "Картинка в картинке".	35	
	Метка вторичного аудио	Позволяет включать и выключать отображение Метка вторичного аудио при воспроизведении диска Blu-ray/DVD с вторичным аудиопотоком.	35	
	Последняя память	Проигрыватель запоминает место на диске (Blu-ray или DVD-Video), где было остановлено воспроизведение при переходе в режим ожидания или в случае открытия лотка диска.	35	
	DivX (R) VOD DRM	Отображение регистрационного кода для видео DivX(R).	35	
	DivX Субтитры	Позволяет выбрать, необходимо ли отображать субтитры для видео DivX(R).	35	
	DVD-Audio	Позволяет выбрать режим воспроизведения дисков DVD-Audio.	35	
	Безопасность			
	Изменение пароля	Изменение пароля для функций "Родительский контроль" и "Код страны".	35	
	Родительский контроль	Позволяет включать функцию "Родительский контроль" в зависимости от содержания диска.	35	
	Код страны	Установка "Код страны".	35	
	Сеть			
	Тип соединения	Установка метода сетевого подключения.	36	
	Информация	Отображение экрана с информацией о сети.	36	
	Проверка соединения	Выполнение проверки соединения с сетью.	36	
	Настройка IP	Установка для параметра "Настройка IP" значения "Авто" или "Вручную".	36	
Настройки прокси-сервера	Выполнение настроек прокси-сервера.	36		
Управление по сети	Установка для режима управления устройствами, подключенными по сети Ethernet, значения "Вкл" или "Выкл".	36		
Режим Network Standby	Установка возможности включения проигрывателя с помощью другого устройства в сети.	36		
Контроль DMC	Определяет, допускается ли управление проигрывателем с помощью совместимого с DLNA устройства Digital Media Controller (DMC) (стр. 16).	36		
BD-Live соединения	Установка для параметра "BD-Live соединения" значения "Разрешенное", "Частичное Разрешенное" или "Запрещенные".	36		

Меню/подменю	Элемент	Функция	Стр.	
 Настройка дисплея	ТВ	3D Выход	Выбор видеоизображения в формате 3D или 2D.	37
		ТВ экран	Можно установить соотношение сторон экрана подключенного телевизора и отрегулировать выводимое изображение.	37
		Разрешение HDMI	Выбор разрешения для вывода видеосигнала по HDMI.	37
		ТВ система	Установка для параметра “ТВ система” значения “NTSC”, “PAL” или “Мультисистемный”.	37
		Цветовое пространство	Установка для параметра “Цветовое пространство” значения “YCbCr 4:4:4”, “YCbCr 4:2:2”, “Full RGB” или “RGB”.	37
		HDMI Deep Color	Установка для параметра “HDMI Deep Color” значения “30 bits”, “36 bits”, “48 bits”, или “Выкл”.	38
	Видео обработка	HDMI 1080p 24Hz	Установка для параметра “HDMI 1080p 24Hz” значения “Авто” или “Выкл”.	38
		Шумоподавление	Выбор уровня шумоподавления.	38
	Скрытые субтитры	Режим деинтерлейсинга	Выбор способа обнаружения видеосигнала.	38
		Настройки субтитров	Установка необходимости отображения скрытых субтитров.	38
		Цвет шрифта Размер шрифта Стиль шрифта Прозрачность шрифта Ширина линий шрифта Цвет линии шрифта Цвет фона Прозрачность фона Цвет окна Прозрачность окна	Настройка шрифта, фона и параметров окна, используемых для показа скрытых субтитров, когда для параметра “Настройки субтитров” выбрано значение “Пользовательские”.	38
		Аудиовыход	Коаксиальный / Оптический	Установка для гнезда “COAXIAL” или разъема “OPTICAL” режима вывода “Bitstream”, “PCM”, “Перекодировать” или “Выкл”.
HDMI			Установка для разъема “HDMI” режима вывода “Bitstream”, “PCM”, “Перекодировать” или “Выкл”.	38
Дискретизация			Установка для параметра частоты дискретизации цифрового аудиосигнала значения 48K/96K/192K.	38
DRC контроль динамического диапазона			Настройка параметра “DRC” (компрессия динамического диапазона).	38
SACD Выходной	Приоритетный выход		Установка приоритета вывода сигнала HDMI или “Аналог” при воспроизведении дисков SA-CD.	39
	SACD приоритет		Выбор приоритета воспроизведения для 2-канального или многоканального содержимого, если диск содержит оба типа содержимого.	39
	HDMI Выход	Выбор DSD или PCM в качестве режима вывода с разъема HDMI при воспроизведении диска SA-CD.	39	
Установки колонок	2ch Downmix	Настройка вывода аудиосигнала с гнезда “AUDIO OUT L/R”.	39	
Пост-обработки	Микширование	Разбиение 2-канального аудиосигнала на несколько каналов.	39	
 Информация о системе		Отображение версии программного обеспечения и MAC-адреса (стр. 48).	39	

■ Пример использования меню УСТАНОВКИ

Для выполнения настроек проигрывателя необходимо вывести на экран меню УСТАНОВКИ. Ниже приведены пояснения, касающиеся основных операций с меню УСТАНОВКИ.

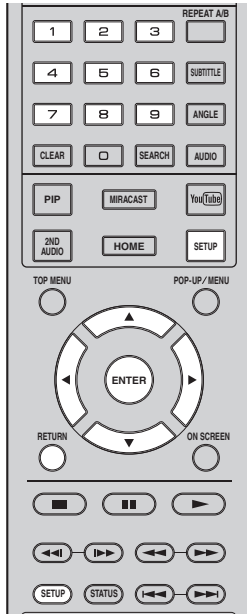

Пример. Установка автоматического воспроизведения дисков

Примечание

- Настройку некоторых элементов не удастся выполнить во время воспроизведения. В этом случае нажмите **■**, чтобы полностью остановить воспроизведение, и переходите к настройкам.

1. Отображение экрана меню УСТАНОВКИ.

Нажмите **SETUP** для отображения экрана меню УСТАНОВКИ.

С помощью кнопок **◀/▶** выберите элемент “Общие установки”, а затем нажмите кнопку **ENTER** или **▼**.

2. Выберите подменю.

С помощью кнопок **▲/▼** выберите элемент “Воспроизведение”, а затем нажмите кнопку **ENTER** или курсорную кнопку **▶**.

3. Выберите элемент меню.

С помощью кнопок **▲/▼** выберите элемент “Автоматическое воспроизведение дисков”, а затем нажмите кнопку **ENTER** или курсорную кнопку **▶**.



4. Выберите необходимое значение.

С помощью кнопок **▲/▼** выберите значение “Вкл.” или “Выкл.”, а затем нажмите кнопку **ENTER**.



Совет

- При работе с некоторыми элементами меню потребуется вводить числа (например, при вводе пароля) с помощью цифровых кнопок.

5. Закройте экран меню.

Нажмите **◀**, чтобы вернуться в предыдущее меню.

■ Общие установки



Установки по умолчанию обозначены символом “*”.

Система

Авто режим ожид.

Включение или выключение функции энергосбережения. Если эта функция включена, проигрыватель перейдет в режим сохранения экрана, если в течение 5 минут не будет выполнено ни одного действия. Если после этого в течение 15 минут не будет выполнено ни одного действия, проигрыватель перейдет в режим ожидания.

Вкл*, Выкл

HDMI контроль

Настройка проигрывателя для получения управляющего сигнала от телевизора или аудио/видео ресивера, совместимого с функцией “HDMI контроль”, по кабелю HDMI (стр. 12).

Вкл, Выкл*

Использование функции “HDMI контроль”

Используя функцию “HDMI контроль”, можно в интерактивном режиме управлять данным проигрывателем с помощью телевизора (поддерживающего функцию “HDMI контроль”). Подключив с помощью кабеля HDMI проигрыватель к телевизору, поддерживающему функцию “HDMI контроль”, и включив функцию “HDMI контроль” в меню УСТАНОВКИ (стр. 34), можно использовать перечисленные ниже функции.

- Функция автоматического выбора входного сигнала
В случае начала воспроизведения на данном проигрывателе, селектор входов телевизора (и аудио/видео ресивера, если проигрыватель подключен к телевизору через аудио/видео ресивер) автоматически переключается на проигрыватель. В зависимости от телевизора подача питания может включаться автоматически.
- Функция автоматического выключения питания
В случае выключения телевизора в то время, когда проигрыватель находится в режиме остановки и на экране не отображается меню УСТАНОВКИ, питание проигрывателя отключается автоматически.

Примечания

- В зависимости от телевизора могут наблюдаться отклонения в работе функции “HDMI контроль”.
- Работа других функций, кроме указанных, зависит от телевизора или аудио/видео ресивера.
- Чтобы сделать доступной функцию “HDMI контроль”, выполните настройку функции “HDMI контроль” на ВСЕХ компонентах (данный проигрыватель, телевизор и аудио/видео ресивер). Может потребоваться выполнить некоторые операции.
- В зависимости от телевизора, каждая функция может быть настроена на самостоятельную активацию/деактивацию.
- Для получения более подробной информации по установке обратитесь к прилагаемому руководству пользователя для телевизора и/или аудио/видео ресивера.
- При включении функции потребление питания в режиме ожидания возрастает в результате работы функции “HDMI контроль”.

Загрузка исходных параметров

Можно сбросить все настройки проигрывателя к значениям по умолчанию, кроме настроек параметров безопасности (стр. 35). Для получения дополнительной информации о настройках по умолчанию см. стр. 31–39.

Обновление программного обеспечения

Можно вручную обновить программное обеспечение с с USB устройства или с сети Network. Для получения дополнительной информации об обновлении программного обеспечения см. раздел “Обновление программного обеспечения” (стр. 42).

Обновление уведомлений

Настройка отображения сообщения на экране при обнаружении проигрывателем новой версии программного обеспечения в сети Интернет.

Вкл*, Выкл

Сообщение о 3D воспроизведении

Можно включить или отключить предупреждающее сообщение, касающееся воспроизведения видео в формате 3D, которое появляется на экране телевизора при включении проигрывателя.

Вкл*, Выкл

Запоминающее устройство

Отображение количества свободного места на подключенном к проигрывателю запоминающем устройстве USB, а также форматирование (опустошение) папки “BUDA” на запоминающем устройстве путем выбора функции “Форматировать”.

Совет

- Для использования функции BD-Live (стр. 30) подсоедините запоминающее устройство USB (имеющее до 2 Гб свободного места) к одному из разъемов USB (лицевой/задний) проигрывателя с целью использования данного запоминающего устройства в качестве локального хранилища.

Простая установка

Выполнение процедуры “Простая установка” (стр. 19).

Язык

Экранное меню

Выбор языка экранного меню, на котором будут отображаться сообщения или меню на экране, например, меню УСТАНОВКИ.

English, Franзais, Espacol, Deutsch, Italiano, Svenska, Nederlandse, Polski, Русский, 中文

Меню диска

Можно установить приоритетный язык для меню диска.

English, Franзais, 中文, Espacol, Deutsch, Italiano, Nederlandse, Португальский, Датский, Svenska, Финский, Норвежский, Polski, Русский, Корейский, Японский, Больше

Аудио

Установка приоритетного языка звучания для воспроизведения диска Blu-ray/DVD. Для получения дополнительной информации о настройке элементов меню см. раздел “Меню диска” (стр. 34).

Субтитры

Установка приоритетного языка субтитров.

English, Français, 中文, Espagnol, Deutsch, Italiano, Nederlandse, Português, Датский, Svenska, Финский, Норвежский, Polski, Русский, Корейский, Японский, Больше, Выкл

(Значение по умолчанию в меню [Язык] зависит от модели устройства.)

Воспроизведение

Автоматическое воспроизведение дисков

Включение или выключение режима “Автоматическое воспроизведение дисков”. Если эта функция включена, диск автоматически будет воспроизведен после загрузки.

Вкл*, Выкл

Угловая метка

Позволяет включать и выключать отображение Угловая метка () при воспроизведении диска Blu-ray/DVD, записанного с разными углами зрения.

Вкл*, Выкл

PIP метка

Позволяет включать и выключать отображение PIP метка () при воспроизведении диска Blu-ray с функцией “Картинка в картинке” (стр. 30).

Вкл*, Выкл

Метка вторичного аудио

Позволяет включать и выключать отображение Метка вторичного аудио () при воспроизведении диска Blu-ray, записанного с вторичным аудиопотоком.

Вкл*, Выкл

Последняя память

Проигрыватель запоминает место на диске (Blu-ray или DVD), где было остановлено воспроизведение, при переходе в режим ожидания или в случае открытия лотка диска.

Вкл*, Выкл

Примечание

- Некоторые диски не поддерживают данную функцию.

DivX (R) VOD DRM

Позволяет выбрать, необходимо ли отображать регистрационный код для видео DivX(R).

DivX Субтитры

Позволяет выбрать, необходимо ли отображать субтитры для видео DivX(R).

Вкл, Выкл*

DVD-Audio

Позволяет выбрать режим воспроизведения дисков DVD-Audio.

DVD АУДИО* Включение воспроизведения содержимого дисков DVD-Audio и DVD-Video.

DVD ВИДЕО Отключение воспроизведения содержимого дисков DVD-Audio для воспроизведения содержимого только дисков DVD-Video.

Примечания

- Выполнение данной настройки возможно только при отсутствии диска.
- Некоторые заголовки DVD-Audio включают в себя содержимое DVD-Video, которое может быть доступно только в случае, когда данный проигрыватель находится в режиме DVD-Video.

Безопасность

Изменение пароля

Установка пароля для изменения уровня параметра “Родительский контроль” и значения параметра “Код страны”. См. раздел “Родительский контроль” (стр. 35) и “Код страны” (стр. 35).

Примечания

- Паролем по умолчанию является 0000.
- Если вы забыли пароль, обратитесь к разделу “Устранение неисправностей” (стр. 43) и восстановите для параметров “Безопасность” значения по умолчанию.

Родительский контроль

На некоторых дисках Blu-ray/DVD контрольный уровень для просмотра диска устанавливается в зависимости от возраста зрителя. Установка отображения информации о параметре “Родительский контроль” в зависимости от содержимого диска. Пароль (см. раздел “Изменение пароля” на стр. 35) необходимо ввести до установки уровня родительского контроля.

После установки параметра “Родительский контроль” при воспроизведении диска, уровень параметра “Родительский контроль” для которого выше установленного, а также при попытке изменить уровень параметра “Родительский контроль” отобразится диалоговое окно с предложением ввести пароль.

Выкл*, 1–8

Код страны

Установка значения параметра “Код страны” в соответствии со страной проживания. До установки параметра “Код страны” необходимо указать пароль (см. раздел “Изменение пароля” на стр. 35). Эти настройки можно использовать для задания уровня параметра “Родительский контроль” и воспроизведения диска.

Сеть

Тип соединения

Можно выбрать способ выполнения сетевого подключения.

Проводное соединение* Подключение к сети с помощью Ethernet.

Беспроводные Подключение к сети по беспроводной связи. Выбор настроек подключения к беспроводной сети. Для продолжения следуйте инструкциям на экране.

Поиск

Поиск точки доступа. Можно подключиться к найденной точке доступа.

Вручную

Можно вручную настроить информацию о точке доступа.

Авто

Если точка доступа поддерживает функцию WPS (Wi-Fi Protected Setup), для подключения проигрывателя к точке доступа можно воспользоваться функцией автонастройки без необходимости указывать информацию вручную. Выберите PBC (настройка нажатием кнопки) или метод ввода PIN-кода.

Информация

Можно отобразить экран с информацией о сети. На этом экране можно просмотреть следующую информацию: интерфейс (Ethernet), Тип адреса, IP адрес, Маска подсети, Основной шлюз и DNS.

Проверка соединения

Выполнение проверки подключения к Интернету. В случае неудачного результата проверки см. раздел “Настройка IP” (стр. 36) и повторите проверку.

Настройка IP

Можно настроить параметры сети.

Авто* Выбор автоматической настройки параметров сети для проигрывателя с помощью сервера DHCP.

Вручную Выбор настройки параметров сети (IP адрес, Маска подсети, Основной шлюз и DNS) вручную.

Советы

- **Numeric keys** Ввод символов.
- **◀▶** Перемещение выделенного фрагмента.
- **CLEAR** Удаление символа.
- **ENTER** Сохранение настроек и выход из меню.

Настройки прокси-сервера

Настройка “Настройки прокси-сервера”. Для обычного использования выберите значение “Выключать”. Для настройки прокси-сервера установите значение “Разрешать”.

Выключать* Прокси-сервер будет выключен. Выберите этот элемент, если прокси-сервер не используется.

Разрешать Включение прокси-сервера и порта прокси-сервера.

Прокси-сервера Выполняются настройки прокси-сервера.

Порт прокси Выполнение настроек порта прокси-сервера.

Управление по сети

Установка для режима управления устройствами, подключенными по сети Ethernet, значения “Вкл” или “Выкл”. Когда выбрано значение “С фильтрацией”, можно указать MAC-адреса устройств в сети, которым будет разрешен доступ к проигрывателю. Этот проигрыватель реализует протокол Yamaha Network Control protocol (YNC).

Вкл*, С фильтрацией, Выкл

Примечания

- При включении параметра “Управление по сети” потребление питания в режиме ожидания возрастает в результате работы функции управления по сети.
- Если установлено значение “Вкл”, время запуска системы уменьшается.

Режим Network Standby

Данный проигрыватель может быть включен посредством других устройств в сети “AV CONTROLLER” (стр. 26).

Вкл, Выкл*

Примечание

- Данная настройка доступна только при включении “Управление по сети”.

Контроль DMC

Можно выбрать, допускается ли управление проигрывателем с помощью совместимого с DLNA устройства Digital Media Controller (DMC) (стр. 16).

Разрешать*, Выключать

BD-Live соединения

Установка ограничения доступа к содержимому BD-Live.

Разрешенное Разрешить подключение к сети для всех дисков с поддержкой BD-Live.

Частичное Разрешены только диски с сертификацией **Разрешенное*** владельца.

Запрещенные Запретить подключение к сети для всех дисков с поддержкой BD-Live.

■ Настройка дисплея



Установки по умолчанию обозначены символом “*”.

ТВ

3D Выход

Можно выбрать вывод видеоизображения в формате 3D или 2D с помощью проигрывателя.

Авто* Проигрыватель автоматически выбирает видеоизображения в формате 3D или 2D.

Выкл Проигрыватель всегда выбирает видеоизображения в формате 2D.

Примечание

- Даже если для параметра “3D Выход” задано значение “Авто” и воспроизводится диск Blu-ray 3D, проигрыватель выбирает изображения в формате 2D в зависимости от настройки телевизора и т.д.

ТВ экран

Можно установить соотношение сторон экрана подключенного телевизора и отрегулировать выводимое изображение.

В случае замены телевизора (например, из-за покупки нового) и изменения соотношения сторон экрана подключенного телевизора необходимо изменить настройки “ТВ экран”.



16:9 Full Выберите это значение, если проигрыватель подключен к телевизору с экраном 16:9. При воспроизведении видео с соотношением сторон экрана 4:3 видео отображается следующим образом.

16:9 Normal* Выберите это значение, если проигрыватель подключен к телевизору с экраном 16:9. При воспроизведении видео с соотношением сторон экрана 4:3 видео отображается следующим образом.

4:3 Pan Scan Выберите это значение, если проигрыватель подключен к телевизору с экраном 4:3. При воспроизведении видео с соотношением сторон экрана 16:9 видео отображается следующим образом.

4:3 Letter Box Выберите это значение, если проигрыватель подключен к телевизору с экраном 4:3. При воспроизведении видео с соотношением сторон экрана 16:9 видео отображается следующим образом.

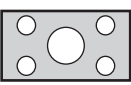
Истинный размер изображения	На телевизоре 16:9 (широкоэкранный)	
	16:9 Full	16:9 Normal
 <p>4:3</p>		

Истинный размер изображения	На телевизоре 4:3	
	4:3 Pan Scan	4:3 Letter Box
 <p>16:9</p>		

Разрешение HDMI

Выбор разрешения для вывода видеосигнала по HDMI. Для получения дополнительной информации о форматах вывода см. раздел “О форматах вывода изображения через HDMI” (стр. 41).

При выборе значения “Авто” устанавливается максимальное разрешение в соответствии с характеристиками подключенного телевизора. Если установлено значение “Исходные параметры диска”, используется исходное разрешение и видеочастота, соответствующие данным, записанным на воспроизводимом диске Blu-ray или DVD. Можно использовать функцию преобразования видео с повышением частоты внешнего устройства.

При воспроизведении диска, отличного от Blu-ray или DVD, для параметров разрешения и видеочастоты будут использоваться значения “Авто”.

При воспроизведении дисков Blu-ray или DVD, параметры разрешения и видеочастоты которых не совместимы с подключенным телевизором, изображение будет отсутствовать. В этом случае остановите воспроизведение и выберите параметр, отличный от “Исходные параметры диска”.

Авто*, Исходные параметры диска, 480i/576i, 480p/576p, 720p, 1080i, 1080p

Примечание

- Для вывода аудио в формате HD (Dolby TrueHD или DTS-HD Master Audio) посредством разъема HDMI установите для параметра “Разрешение HDMI” значение “Авто” или значение выше, чем “720p”.

ТВ система

Для параметра “ТВ система” можно установить значение “PAL”, “NTSC” и “Мультисистемный”. Выберите значение параметра “ТВ система” в соответствии с используемым телевизором. Для получения дополнительной информации о форматах вывода см. раздел “О форматах вывода изображения через HDMI” (стр. 41).

NTSC, PAL, Мультисистемный

(Значение по умолчанию зависит от модели устройства.)

Цветовое пространство

Выбор цветового пространства (стр. 48) для вывода сигнала через HDMI. Эта функция доступна, если проигрыватель подключен с помощью кабеля HDMI.

YCbCr 4:4:4* Установка для цветового пространства значения YCbCr 4:4:4.

YCbCr 4:2:2 Установка для цветового пространства значения YCbCr 4:2:2.

Full RGB Если при выборе значения “RGB” черные и белые тона на экране слишком блеклые, выберите этот элемент. Данный параметр работает, когда подключенный компонент поддерживает диапазон RGB 0–255.

RGB Видеосигнал выводится в нормальном диапазоне сигналов.

Примечание

- Эта функция доступна, только если телевизор поддерживает эту функцию.

HDMI Deep Color

Если телевизор и/или аудио/видео ресивер совместим с функцией “Deep Color” (стр. 47), установите этот параметр в соответствии с характеристиками телевизора или аудио/видео ресивера. Эта функция доступна, если проигрыватель подключен с помощью кабеля HDMI.

30 bits, 36 bits, 48 bits, Выкл*

HDMI 1080p 24Hz

При этом сигнал BD-Video будет выводиться с частотой кадров 24 Гц в режиме HDMI 1080p 24Hz. С помощью этой функции воспроизведение видео будет более сглаженным. Эта функция доступна, только если ее поддерживает телевизор или аудио/видео ресивер. Для получения дополнительной информации о форматах вывода см. раздел “О форматах вывода изображения через HDMI” (стр. 41).

Авто*, Выкл

Примечание

- Если установлено другое разрешение, кроме 1080p, этот параметр будет отключен.

Видео обработка

Шумоподавление

Для параметра “Шумоподавление” можно установить уровень от 0 до 3. 0 соответствует значению “выключено”, а 3 – максимальному уровню.

0, 1, 2*, 3

Режим деинтерлейсинга

Выбор способа обнаружения видеосигнала. Для обычного использования выберите значение “Авто”. Если на экране появляются помехи в виде горизонтальных полос, установите для данного параметра значение “Пленка” или “ВИДЕО”.

Авто*, Пленка, ВИДЕО

Скрытые субтитры

Настройки субтитров

Установка необходимости отображения скрытых субтитров. Если выбрано значение Авто, цифровые скрытые субтитры будут отображаться с настройками по умолчанию. Если выбрано значение Пользовательские, пользователь может настроить отображение скрытых субтитров (Цвет шрифта, Размер шрифта и т. д.) вручную.

Авто, Пользовательские

Цвет шрифта, Размер шрифта, Стиль шрифта, Прозрачность шрифта, Ширина линий шрифта, Цвет линии шрифта, Цвет фона, Прозрачность фона, Цвет окна, Прозрачность окна

Настройка шрифта, фона и параметров окна, используемых для показа скрытых субтитров, когда для параметра “Настройки субтитров” выбрано значение “Пользовательские”.

Настройка звука



Установки по умолчанию обозначены символом “*”.

Аудиовыход

Коаксиальный / Оптический

Можно выбрать режим вывода для гнезда COAXIAL и разъема OPTICAL. Для получения дополнительной информации о форматах вывода см. раздел “Форматы аудиовыходов” (стр. 40).

Bitstream Вывод необработанного цифрового сигнала. Вторичное аудио не выводится.

PCM Вывод 2-канального звука в формате PCM.

Перекодировать* Вывод потока данных вторичного аудио.

Выкл Приглушение звука.

HDMI

Можно выбрать режим вывода разъема HDMI. Для получения дополнительной информации о настройке элементов меню см. раздел “Коаксиальный / Оптический” (стр. 38). Для получения дополнительной информации о форматах вывода см. раздел “Форматы аудиовыходов” (стр. 40).

Bitstream*, PCM, Перекодировать, Выкл

Примечание

- Для вывода аудио в формате HD (Dolby TrueHD или DTS-HD Master Audio) посредством разъема HDMI, установите для параметра “Разрешение HDMI” значение “Авто” или значение выше, чем “720p”. (стр. 37)

Дискретизация

Можно выбрать частоту дискретизации цифрового аудиосигнала. Эта функция действует при выводе аудиосигнала с гнезда COAXIAL или разъема OPTICAL.

48K* Максимальная частота дискретизации при выводе цифрового PCM-сигнала составляет 48 кГц.

96K Максимальная частота дискретизации при выводе цифрового PCM-сигнала составляет 96 кГц.

192K Максимальная частота дискретизации при выводе цифрового PCM-сигнала составляет 192 кГц.

DRC контроль динамического диапазона

Установка для параметра DRC (компрессия динамического диапазона) (стр. 47) значения “Вкл.”, “Выкл.” или “Авто”. При установке значения “Авто” параметр DRC включается автоматически для источника с информацией DRC в формате Dolby TrueHD. Параметр DRC уменьшает громкость чрезмерно громких звуков, таких как взрывы, и повышает громкость диалогов. Это удобно при просмотре фильмов в ночное время.

Выкл, Вкл, Авто*

■ Информация о системе



Отображение версии программного обеспечения и MAC-адреса (стр. 48).

SACD Выходной

Приоритетный выход

Можно установить приоритет вывода сигнала HDMI или “Аналог” при воспроизведении дисков SA-CD.

HDMI*	Настройки применяются для параметров “SACD приоритет” и “HDMI Выход”.
Аналог	Воспроизведение исключительно слоя диска SA-CD с высококачественным 2-канальным звуком. Сигнал полностью оптимизирован для вывода аналогового 2-канального звука с наивысшим качеством.

Примечание

- Выбор значения “Аналог” отключает выход HDMI при воспроизведении диска SA-CD. Подробнее см. в разделе “Выходные форматы диска SA-CD” (стр. 41).

SACD приоритет

Выбор приоритета воспроизведения для 2-канального или многоканального содержимого, если диск содержит оба типа содержимого.

Multi-CH*, 2-CH

HDMI Выход

Вывод сигнала с разъема HDMI можно выбрать во время воспроизведения диска SA-CD.

DSD*	Вывод необработанного сигнала DSD. Если проигрыватель подключен к аудио/видео ресиверу с поддержкой DSD, рекомендуется выбрать это значение.
PCM	Вывод сигнала PCM, декодированного данным проигрывателем.

Установки колонок

2ch Downmix

Можно выбрать способ микширования до аналогового 2-канального сигнала из сигнала “Стерео” или “Lt/Rt”.

Стерео*	Установка вывода канала в стереофоническом режиме, что обеспечивает вывод звука только из двух фронтальных динамиков.
Lt/Rt	Выберите это значение, если данный аппарат подключен к декодеру Dolby Pro Logic. Звук задних динамиков микшируется в 2-канальный стереофонический звук.

Пост-обработки

Микширование

Разбиение 2-канального аудиосигнала на несколько каналов. Для разбиения на несколько каналов выберите значение DTS NEO:6, затем выберите режим “Кинотеатр” или “Музыка”.

Выкл*, DTS NEO:6

■ Форматы аудиовыходов

Формат источника		HDMI			COAXIAL / OPTICAL			MIXED 2CH
		Bitstream	PCM	Перекодировать	Bitstream	PCM	Перекодировать	–
PCM 2-канальный	с поддержкой ВА или ЗНК*1	PCM 2-канальный		Dolby Digital	PCM 2-канальный		Dolby Digital	2-канальный
	без поддержки ВА или ЗНК*1	PCM 2-канальный			PCM 2-канальный			2-канальный
PCM 5.1-канальный	с поддержкой ВА или ЗНК*1	PCM 5.1-канальный		Dolby Digital	PCM 2-канальный		Dolby Digital	2-канальный
	без поддержки ВА или ЗНК*1	PCM 5.1-канальный			PCM 2-канальный			2-канальный
PCM 7.1-канальный	с поддержкой ВА или ЗНК*1	PCM 7.1-канальный		Dolby Digital	PCM 2-канальный		Dolby Digital	2-канальный
	без поддержки ВА или ЗНК*1	PCM 7.1-канальный			PCM 2-канальный			2-канальный
Dolby Digital	с поддержкой ВА или ЗНК*1	Dolby Digital	PCM до 5.1-канального	Dolby Digital	Dolby Digital	PCM 2-канальный	Dolby Digital	2-канальный
	без поддержки ВА или ЗНК*1							
Dolby Digital Plus	с поддержкой ВА или ЗНК*1	Dolby Digital Plus	PCM до 7.1-канального	Dolby Digital	Dolby Digital	PCM 2-канальный	Dolby Digital	2-канальный
	без поддержки ВА или ЗНК*1			Dolby Digital Plus				
Dolby TrueHD	с поддержкой ВА или ЗНК*1	Dolby TrueHD	PCM до 7.1-канального	Dolby Digital	Dolby Digital	PCM 2-канальный	Dolby Digital	2-канальный
	без поддержки ВА или ЗНК*1			Dolby TrueHD				
DTS	с поддержкой ВА или ЗНК*1	DTS	PCM до 5.1-канального*2	DTS*3	DTS	PCM 2-канальный*2	DTS*3	2-канальный*2
	без поддержки ВА или ЗНК*1							
DTS HD High Resolution	с поддержкой ВА или ЗНК*1	DTS-HD High Resolution	PCM до 7.1-канального*2	DTS*3	DTS	PCM 2-канальный*2	DTS*3	2-канальный*2
	без поддержки ВА или ЗНК*1			DTS HD High Resolution*3				
DTS-HD Master Audio	с поддержкой ВА или ЗНК*1	DTS-HD Master Audio	PCM до 7.1-канального*2	DTS*3	DTS	PCM 2-канальный*2	DTS*3	2-канальный*2
	без поддержки ВА или ЗНК*1			DTS-HD Master Audio*3				

*1 “ВА” обозначает “вторичное аудио”. “ЗНК” обозначает “звук нажатия кнопки”, т.е. звуковой эффект для всплывающих окон и т.д.

*2 Для USB, DLNA и сетевых служб не поддерживается вывод 2-канального микшированного звука и звука в формате PCM (звук будет отсутствовать).

*3 Для USB, DLNA и сетевых служб недоступен вариант “Перекодировать” (выходной аудиопоток будет иметь тот же формат, что и поток данных).

Примечания

- При установке для параметра “Коаксиальный / Оптический” или “HDMI” значения “Bitstream” вторичная звуковая дорожка не воспроизводится. (стр. 38)
- Для вывода аудиоформата HD (например, Dolby TrueHD или DTS-HD Master Audio) с разъема HDMI установите для параметра “Разрешение HDMI” значение “Авто” или значение выше, чем 720p. (стр. 37)

Выходные форматы диска SA-CD

Настройки вывода сигнала для дисков SA-CD (стр. 39)			HDMI	КОАКСИАЛЬНЫЙ / ОПТИЧЕСКИЙ	MIXED 2CH
Приоритет вывода сигнала	SACD приоритет	HDMI Выход			
HDMI	Multi-CH	DSD	DSD до 5.1-канального	Не выводится	2-канальный
		PCM	PCM до 5.1-канального	Не выводится	2-канальный
	2-CH	DSD	DSD 2-канальный	Не выводится	2-канальный
		PCM	PCM 2-канальный	Не выводится	2-канальный
Аналог	Multi-CH	DSD	Не выводится	Не выводится	2-канальный
		PCM	Не выводится	Не выводится	2-канальный
	2-CH	DSD	Не выводится	Не выводится	2-канальный
		PCM	Не выводится	Не выводится	2-канальный

■ О форматах вывода изображения через HDMI

При установке для параметра “ТВ система” значения “NTSC”

Содержание	Разрешение HDMI						
	Авто	Исходные параметры диска	1080p	1080i	720p	480p/576p	480i/576i
BD-Video с изображением 1080p/24 Гц	*1	1080p 24 Гц	1080p 24 Гц/ 60 Гц *3	1080i 60 Гц	720p 60 Гц	480p	480i
BD-Video с изображением, отличным от 1080p/24 Гц	*1	*2	1080p 60 Гц	1080i 60 Гц	720p 60 Гц	480p	480i
DVD-Video	*1	*2	1080p 60 Гц	1080i 60 Гц	720p 60 Гц	480p	480i
Прочее	*1	*1	1080p 60 Гц	1080i 60 Гц	720p 60 Гц	480p	480i

При установке для параметра “ТВ система” значения “PAL”

Содержание	Разрешение HDMI						
	Авто	Исходные параметры диска	1080p	1080i	720p	480p/576p	480i/576i
BD-Video с изображением 1080p/24 Гц	*1	1080p 24 Гц	1080p 24 Гц/ 50 Гц *3	1080i 50 Гц	720p 50 Гц	576p	576i
BD-Video с изображением, отличным от 1080p/24 Гц	*1	*2	1080p 50 Гц	1080i 50 Гц	720p 50 Гц	576p	576i
DVD-Video	*1	*2	1080p 50 Гц	1080i 50 Гц	720p 50 Гц	576p	576i
Прочее	*1	*1	1080p 50 Гц	1080i 50 Гц	720p 50 Гц	576p	576i

*1 Будет установлено максимальное разрешение, поддерживаемое подключенным телевизором.

Например, если максимальное разрешение, поддерживаемое подключенным телевизором, составляет 1080p, будет установлено разрешение 1080p.

*2 Разрешение и частота будут соответствовать таковым для исходного диска.

*3 Если для параметра “Авто” выбрано значение “HDMI 1080p 24 Гц” и подключенный телевизор поддерживает вывод изображения в формате 1080p 24 Гц, то содержимое будет выводиться в формате 1080p 24 Гц, а не 1080p 50/60 Гц.

При установке для параметра “ТВ система” значения “Мультисистемный”

При установке для параметра “ТВ система” значения “Мультисистемный” видеосигнал выводится с частотой сигнала источника. Для получения дополнительной информации о параметрах частоты телевизора и разрешения выходного видеосигнала см. таблицу выше.

Примечания

- Если разрешение выходного видеосигнала отлично от 1080p, значение “HDMI 1080p 24Hz” недоступно.
- Если для параметра “ТВ система” установлено значение “NTSC”, но частота источника видео не соответствует значению 60 Гц, видеосигнал на выходе будет преобразован в сигнал с частотой 60 Гц.
- Если для параметра “ТВ система” установлено значение “PAL”, но частота источника видео не соответствует значению 50 Гц, видеосигнал на выходе будет преобразован в сигнал с частотой 50 Гц.

Обновление программного обеспечения

По мере необходимости будет выпускаться программное обеспечение с новыми функциями и улучшениями. Рекомендуется регулярно обновлять программное обеспечение проигрывателя до последней версии.

Проверить наличие обновления программного обеспечения можно по адресу:
<http://download.yamaha.com/>

Примечание

- Не извлекайте запоминающее устройство USB, не переводите проигрыватель в режим ожидания и не отсоединяйте кабель питания/сетевой кабель во время обновления программного обеспечения.

■ Обновление программного обеспечения

1. Выполните подготовку к обновлению программного обеспечения.

При обновлении программного обеспечения с запоминающего устройства USB:

- ① Сохраните файл с пакетом обновления в соответствующую папку на запоминающем устройстве USB. Для получения дополнительной информации см. инструкцию, прилагаемую к файлу с пакетом обновления.
- ② Подключите запоминающее устройство USB.

При обновлении программного обеспечения по сети:

Убедитесь, что проигрыватель подключен к сети.

2. Выберите способ обновления и запустите обновление в меню УСТАНОВКИ.

- ① Нажмите **SETUP** для отображения экрана меню УСТАНОВКИ.
- ② Выберите Общие установки → Система → ОБНОВИТЬ.
- ③ Выберите, где содержится файл с пакетом обновления, с USB устройства или с сети Network.

3. Выполните обновление программного обеспечения, следуя указаниям на экране.

Обновление завершено. Система будет перезапущена.



Система выполнит поиск файла с пакетом обновления.





Устранение неисправностей

Если проигрыватель функционирует неправильно, обратитесь к приведенной ниже таблице. В случае, если проблема не указана в таблице или проблему не удалось устранить, выключите проигрыватель, отсоедините кабель питания и обратитесь к ближайшему авторизованному дилеру или в сервисный центр Yamaha.

■ Питание

Неисправность	Вероятная причина и методы устранения
Нет питания.	<ul style="list-style-type: none"> – Правильно подсоедините прилагаемый кабель питания переменного тока. – Нажмите кнопку  на передней панели, чтобы включить питание.
Питание проигрывателя выключается.	<ul style="list-style-type: none"> – Проигрыватель автоматически отключается через 20 минут бездействия (отсутствие воспроизведения), когда включена функция автоматического режима ожидания (стр. 34).

■ Основные операции

Неисправность	Вероятная причина и методы устранения
Пульт дистанционного управления не работает.	<ul style="list-style-type: none"> – Используйте пульт дистанционного управления в пределах его рабочего диапазона. (стр. 11) – Замените батарейки. (стр. 11) – Проверьте настройки идентификационного кода основного аппарата и пульта дистанционного управления. Идентификатор пульта дистанционного управления основного устройства можно изменить после сброса основного устройства. В этом случае проверьте идентификатор пульта дистанционного управления на основном устройстве и при необходимости установите снова. (стр. 11)
Кнопки не работают.	<ul style="list-style-type: none"> – Чтобы сбросить настройки проигрывателя, нажмите и удерживайте кнопку  на передней панели более 5 секунд, а затем отпустите ее. – Для полной перезагрузки проигрывателя отсоедините кабель питания от сети переменного тока на 30 секунд или более, затем снова подсоедините его и включите проигрыватель.
Пароль забыт.	<ul style="list-style-type: none"> – Одновременно нажмите и удерживайте кнопки ,  и  на передней панели, если диск не вставлен и воспроизведение остановлено, чтобы сбросить все настройки проигрывателя, в том числе настройки безопасности (стр. 35), и восстановить значения по умолчанию. После автоматического выключения питания нажмите кнопку  для его повторного включения.

■ Воспроизведение диска

Неисправность	Вероятная причина и методы устранения
Лоток для дисков не открывается или не закрывается.	<ul style="list-style-type: none"> – Лоток для дисков блокируется, когда выбрана любая сетевая служба. Нажмите HOME для выхода из режима работы с сетевой службой (стр. 22). – Лоток для дисков блокируется, когда проигрыватель находится в режиме приема данных <i>Bluetooth</i> или <i>Miracast</i>. Нажмите <i>Bluetooth</i> для выхода из режима <i>Bluetooth</i> (стр. 25) или <i>Miracast</i> для выхода из режима <i>Miracast</i> (стр. 26).
Диск не воспроизводится в проигрывателе.	<ul style="list-style-type: none"> – Извлеките диск и очистите его. (стр. 5) – Убедитесь, что диск правильно введен (ровно лежит в лотке, этикеткой вверх). (стр. 5) – Используйте диск, поддерживаемый проигрывателем. (стр. 3) – Извлеките диск и проверьте, поддерживаются ли такие диски проигрывателем. (стр. 3) – Проверьте региональный код. (стр. 3) – Проверьте диск на предмет дефектов, установив другой диск. – Диски CD-R/RW, DVD+R/RW/R DL и DVD-R/RW/R DL должны записываться с закрытием последней сессии. (стр. 3)
Видео останавливается.	<ul style="list-style-type: none"> – Проигрыватель прекращает воспроизведение в случае толчка или вибрации.
Проигрыватель издает щелчок в момент начала воспроизведения или загрузки диска.	<ul style="list-style-type: none"> – Данные звуки не указывают на неисправность проигрывателя и являются обычными условиями работы.
Для начала воспроизведения диска Blu-ray требуется некоторое время.	<ul style="list-style-type: none"> – При загрузке диска Blu-ray проигрыватель осуществляет поиск запоминающего устройства USB, используемого в качестве запоминающего устройства для функции BD-Live (стр. 30). Для уменьшения времени ожидания оставляйте запоминающее устройство USB присоединенным к одному из разъемов (лицевому/заднему) проигрывателя (стр. 17).

■ Изображение

Неисправность	Вероятная причина и методы устранения
Отсутствует изображение.	<ul style="list-style-type: none"> – Убедитесь, что кабели правильно подключены. (стр. 12) – Убедитесь, что для подключаемого телевизора или аудио/видео ресивера установлен правильный вход. – Извлеките диск или остановите воспроизведение, затем одновременно нажмите и удерживайте кнопки ► и ■ на передней панели, чтобы восстановить значения разрешения видео по умолчанию. Если изображение по-прежнему отсутствует, нажмите и удерживайте кнопку ■ на передней панели в течение приблизительно 5 секунд, чтобы переключиться в режим NTSC/PAL. – Если установлено значение “Исходные параметры диска”, выводится сигнал, несовместимый с подключенным телевизором. Измените настройки для вывода сигнала, совместимого с подключенным телевизором. (стр. 37) – Убедитесь в том, что воспроизводимый диск или файл совместимы с данным проигрывателем (стр. 3).
Изображение на экране застыло и кнопки управления не функционируют.	<ul style="list-style-type: none"> – Нажмите ■, затем повторите запуск воспроизведения. – Выключите питание и снова включите его. – Чтобы сбросить настройки проигрывателя, нажмите и удерживайте кнопку ⏻ на передней панели более 5 секунд, а затем отпустите ее.
Разрешение выводимого видео не соответствует требуемому.	<ul style="list-style-type: none"> – Установите требуемое разрешение. (стр. 37)
Широкоэкранный образ растянут по вертикали, либо на экране присутствуют черные полосы сверху и снизу. Либо видео с соотношением 4:3 вытянуто по горизонтали.	<ul style="list-style-type: none"> – Измените соотношение сторон экрана телевизора. (стр. 37)
На экране появляются помехи в виде квадратов (мозаика).	<ul style="list-style-type: none"> – Блоки в изображениях могут быть видны в эпизодах с быстрым движением из-за характеристик технологии сжатия цифрового изображения.

■ Звук

Неисправность	Вероятная причина и методы устранения
Звук отсутствует или искажен.	<ul style="list-style-type: none"> – Убедитесь, что аудиокабель подключен правильно. (стр. 12) – Увеличьте уровень громкости телевизора или аудио/видео ресивера. – Звук будет отсутствовать в режиме стоп-кадра и ускоренного перехода вперед и назад. (стр. 9) – Звук может не выводиться в зависимости от состояния записи, например в случае записи сигнала, отличного от звукового, или нестандартного сигнала в качестве звукового сопровождения диска. (стр. 3) – Убедитесь в том, что воспроизводимый диск или файл совместимы с данным проигрывателем (стр. 3).
Левый и правый каналы звука заменены местами, либо звук воспроизводится только с одной стороны.	<ul style="list-style-type: none"> – Проверьте аудиоподключения. (стр. 14)
Не слышен желаемый тип аудио и/или количество каналов.	<ul style="list-style-type: none"> – См. параметр “Аудиовыход” и раздел “Форматы аудиовыходов”. (стр. 38, стр. 40)
Не слышен звук при использовании функции PIP (вторичное аудио).	<ul style="list-style-type: none"> – Установите для параметра Коаксиальный / Оптический значение HDMI или PCM/Перекодировать. (стр. 38) – Для прослушивания вторичного аудио нажмите кнопку 2ND AUDIO. (стр. 9) – В зависимости от диска, возможно, потребуются включить параметр вторичного аудио в главном меню диска (стр. 9).

■ Сеть

Неисправность	Вероятная причина и методы устранения
<p>Не устанавливается соединение с Интернетом.</p>	<ul style="list-style-type: none"> – При подключении к Интернету путем выбора Проводное соединение в меню “Тип соединения” подключите сетевой кабель надлежащим образом. (стр. 36) – Включите подсоединенное оборудование, например, широкополосный маршрутизатор или модем. – Правильно подключите широкополосный маршрутизатор и/или модем. – Если для параметра “Беспроводные” выбрано значение “Тип соединения”, но требуется подключиться к Интернету посредством сети Ethernet, выберите значение “Проводное соединение”. (стр. 36) – Выберите значение “Беспроводные” в меню “Тип соединения”, если необходимо подключиться к Интернету с помощью беспроводной сети. (стр. 36)
<p>Не удается загрузить содержимое BD-Live.</p>	<ul style="list-style-type: none"> – Убедитесь, что проигрыватель подключается к Интернету. См. “Проверка соединения” (стр. 36) – Подсоедините запоминающее устройство USB соответствующим образом. Убедитесь, что запоминающее устройство USB подключено к разъему USB проигрывателя. (стр. 17) – Убедитесь, что диск Blu-ray поддерживает BD-Live. – Подсоедините запоминающее устройство USB с файловой системой FAT16, FAT32 или NTFS. – Рекомендуется подключать запоминающее устройство USB с объемом свободного пространства не менее 2 Гб. Если свободного пространства недостаточно, выполните форматирование запоминающего устройства USB. (стр. 34) – Обратитесь к руководству пользователя, прилагаемому к диску, или проконсультируйтесь с производителем диска.
<p>Не удается обнаружить сервер DLNA.</p>	<ul style="list-style-type: none"> – Убедитесь, что проигрыватель подключается к сети. См. “Проверка соединения” (стр. 36) – Включите подсоединенное оборудование, например, широкополосный маршрутизатор или сервер. – Убедитесь, что проигрыватель и сервер подключены к одному маршрутизатору (или точке доступа). – В зависимости от сервера DLNA, может потребоваться разрешить на сервере доступ проигрывателю. – В зависимости от сервера DLNA, может потребоваться изменение настройки межсетевое экрана.
<p>Не удается воспроизвести файл, находящийся на сервере DLNA.</p>	<ul style="list-style-type: none"> – Убедитесь, что файл можно воспроизвести. (стр. 3) – Проверьте настройки сервера DLNA. – Качество воспроизведения и работы может зависеть от условий домашней сети.
<p>Не удается подключиться к Интернету по беспроводной сети.</p>	<ul style="list-style-type: none"> – Убедитесь, что беспроводной маршрутизатор включен. – Расстояние приема сигнала может уменьшаться в зависимости от окружающих условий, например материала стен, условий приема радиоволн и наличия препятствий между проигрывателем и маршрутизатором. Расположите проигрыватель и беспроводной маршрутизатор ближе друг к другу. – Устройства, использующие частотный диапазон 2,4 ГГц, например микроволновая печь, устройство Bluetooth или цифровое беспроводное устройство, могут вызывать помехи для связи. Расположите проигрыватель вдали от таких устройств или выключите эти устройства. – Если подключение к Интернету по беспроводной сети все еще невозможно после выполнения двух вышеупомянутых решений, попробуйте выполнить подключение по Ethernet, выбрав значение Проводное соединение в меню “Тип соединения”. (стр. 36)
<p>Не удается найти беспроводную сеть или связь прерывается.</p>	<ul style="list-style-type: none"> – Убедитесь, что беспроводной маршрутизатор включен. – Переместите проигрыватель ближе к маршрутизатору или измените ориентацию проигрывателя или антенны маршрутизатора. – Если не удастся настроить беспроводное подключение с помощью функции WPS, выберите другой вариант (Поиск или Вручную) (стр. 19). – Убедитесь, что на работу беспроводной связи не оказывают влияние микроволновые печи, беспроводные радиотелефоны или другие расположенные рядом устройства Wi-Fi. – Микроволновые печи, беспроводные радиотелефоны и другие расположенные рядом устройства беспроводной связи могут создавать помехи в работе беспроводной сети. Выключите подобные устройства. – Убедитесь, что межсетевые экраны в сети не запрещают установку беспроводного соединения для проигрывателя. – Если беспроводная сеть не работает должным образом у вас дома, попробуйте установить проводное подключение.

Bluetooth

Неисправность	Вероятная причина и методы устранения
Не удается выполнить сопряжение между проигрывателем и устройством Bluetooth.	<ul style="list-style-type: none"> – Проверьте, что нажата кнопка Bluetooth, а затем кнопка RED, чтобы переключить проигрыватель в режим сопряжения. – Выполните сопряжение с устройством, которое поддерживает A2DP. – Используйте устройство <i>Bluetooth</i> с паролем 0000. – Расположите проигрыватель и устройство <i>Bluetooth</i> ближе друг к другу. – Устройства, использующие частотный диапазон 2,4 ГГц, например микроволновая печь, беспроводная сеть LAN или цифровое беспроводное устройство, могут препятствовать работе соединения. Расположите проигрыватель вдали от таких устройств или выключите эти устройства. – Другое устройство <i>Bluetooth</i> в данный момент подключено. Отключите текущее соединение <i>Bluetooth</i> и выполните сопряжение с новым устройством (стр. 24)
Не удается установить соединение Bluetooth.	<ul style="list-style-type: none"> – Другое устройство <i>Bluetooth</i> в данный момент подключено. Отключите текущее соединение <i>Bluetooth</i> и установите соединение с новым устройством. – Выполнено сопряжение более девяти устройств и информация о самом давнем сопряжении удалена. Выполните сопряжение еще раз (стр. 24).
При воспроизведении звук отсутствует или прерывается.	<ul style="list-style-type: none"> – Соединение <i>Bluetooth</i> между проигрывателем и устройством <i>Bluetooth</i> отключено. Установите соединение повторно (стр. 25). – Расположите проигрыватель и устройство <i>Bluetooth</i> ближе друг к другу. – Устройства, использующие частотный диапазон 2,4 ГГц, например микроволновая печь, беспроводная сеть LAN или цифровое беспроводное устройство, могут препятствовать работе соединения. Расположите проигрыватель вдали от таких устройств или выключите эти устройства. – Убедитесь, что функция <i>Bluetooth</i> включена и настроена на передачу аудиосигналов <i>Bluetooth</i> на устройстве <i>Bluetooth</i>. – Увеличьте уровень громкости на устройстве <i>Bluetooth</i>.

Сообщения на экране

- При воспроизведении неподходящего диска или при возникновении ошибки во время работы на экране телевизора будут появляться следующие сообщения.

Сообщение об ошибке	Вероятная причина и методы устранения
Неподдерживаемый файл	– Файл не поддерживается проигрывателем. См. раздел “Типы дисков/файлов, которые можно использовать с этим проигрывателем” (стр. 3).
Неправильный код региона!	– Несовместимый региональный код диска. См. раздел “Информация об управлении регионами видеофрагментов Blu-ray/DVD” (стр. 3).
Ошибка сети.	– Не удается подключить проигрыватель к сети. Проверьте подключение (стр. 15) и настройку Сеть (стр. 36).
Сеть ОК, ошибка прокси сервера.	– Не удается подключить проигрыватель к прокси-серверу. См. раздел “Настройки прокси-сервера” (стр. 36).
Подключение BD-live запрещено в меню УСТАНОВКИ.	– Подключение BD-Live запрещено. См. раздел “BD-Live соединения” (стр. 36).
Обновление не удалось по ряду причин!	– Ошибка обновления. Убедитесь, что файл обновления не поврежден и доступен для чтения.
IP адрес введен неверно! Пожалуйста попробуйте снова.	– Введенное значение параметра “Настройка IP” неверно. Введите верное значение.

AVCHD

AVCHD — это новый формат (стандарт) для видеокамер высокого разрешения, которые могут быть использованы для записи и воспроизведения изображения HD с высоким разрешением.

BD-Live™

BD-Live является стандартом Blu-ray, использующим сетевое подключение, и позволяет выходить в сеть с помощью проигрывателя и загружать рекламные видеоролики и другие данные.

BDMV

BDMV (Blu-ray Disc Movie, диск с фильмом) представляет собой один из прикладных форматов, используемых для дисков BD-ROM, и является одним из форматов, доступных для дисков Blu-ray. BDMV является форматом записи, эквивалентным формату DVD-Video в соответствии со стандартом DVD.

Blu-ray 3D™

Функция Blu-ray 3D позволяет просматривать полноразмерные изображения высокой четкости в формате 3D.

BONUSVIEW™

При использовании дисков с поддержкой BONUSVIEW можно одновременно воспроизводить дополнительный видеоканал для двух экранов, дополнительный аудиоканал и субтитры. Во время воспроизведения на основном экране отображается небольшой дополнительный экран (картинка в картинке).

Deep Color

Функция Deep Color предполагает использование различной глубины цвета на дисплеях по сравнению с глубиной в 24 бита в предыдущих версиях стандарта HDMI. Дополнительная битовая глубина позволяет телевизорам высокой четкости и другим дисплеям отображать не миллионы, а миллиарды цветов, а также устранять цветовые полосы на экране и обеспечивать плавные тональные переходы и тонкие градации цветов. Увеличенная контрастность позволяет отобразить гораздо больше оттенков серого в переходе от черного цвета к белому. Кроме того, Deep Color увеличивает число возможных цветов в пределах границ, определяемых цветовым пространством RGB или YCbCr.

DivX®

DivX® представляет собой цифровой формат видеоданных, созданный DivX, LLC, подразделением Rovi Corporation. Данное устройство является официальным устройством с сертификацией DivX Certified®, способным воспроизводить видео в формате DivX. На сайте divx.com представлена более подробная информация и программное обеспечение для преобразования файлов в видео в формате DivX.

DLNA

Стандарт DLNA (Digital Living Network Alliance) предназначен для удобной передачи цифрового медиасодержимого по домашней сети, и с помощью этого проигрывателя на телевизоре можно воспроизводить цифровое содержимое, хранящееся на компьютере с установленным программным обеспечением сервера DLNA или другом устройстве, поддерживающим DLNA. Чтобы подключить проигрыватель к серверу DLNA, необходимо выполнить ряд настроек на сервере DLNA или устройстве. Для получения дополнительной информации см. документацию программного обеспечения сервера DLNA или устройства с поддержкой DLNA.

Dolby Digital

Система звука, разработанная компанией Dolby Laboratories Inc., которая придает атмосферу кинотеатра при просмотре фильмов, в случае, если данный аппарат подключен к процессору или усилителю системы Dolby Digital.

Dolby Digital Plus

Система звука, разработанная в качестве расширения к Dolby Digital. Эта технология кодирования аудио поддерживает 7.1 многоканальный объемный звук.

Dolby TrueHD

Dolby TrueHD представляет собой технологию кодирования без потерь, поддерживающую до 8 каналов многоканального объемного звука для оптических дисков нового поколения. Воспроизводимый звук с точностью до бита повторяет оригинальный источник.

DRC (Управление динамическим диапазоном)

DRC позволяет регулировать диапазон между наиболее громкими и тихими звуками (динамический диапазон) для воспроизведения со средней громкостью. Используйте эту функцию, если трудно различить диалог или если при воспроизведении можно потревожить соседей.

DTS

Представляет собой систему цифрового звука, разработанную компанией DTS, Inc. для использования в кинотеатрах.

DTS-HD High Resolution Audio

DTS-HD High Resolution Audio — это новая технология, разработанная для формата нового поколения оптических дисков с данными высокой четкости.

DTS-HD Master Audio

DTS-HD Master Audio — это технология сжатия аудиосигнала без потерь, разработанная для формата нового поколения оптических дисков с данными высокой четкости.

FLAC

FLAC (Free Lossless Audio Codec) — это открытый формат файлов для сжатия аудиоданных без потерь. Несмотря на то, что по степени сжатия он уступает другим форматам сжатия аудиосигналов, качество звука при этом зачастую выше.

HDMI

HDMI (Мультимедийный интерфейс высокой четкости) представляет собой интерфейс, который позволяет осуществлять передачу видеосигнала и аудиосигнала через общее цифровое подключение. Подключение HDMI используется для вывода в цифровой форме без ухудшения качества стандартных видеосигналов и видеосигналов высокого разрешения, а также многоканальных аудиосигналов на аудио/видео устройства, такие как телевизоры, оснащенные разъемом HDMI.

Letterbox (LB 4:3)

Формат экрана с черными полосами в верхней и нижней частях изображения, позволяющий просмотр широкоэкранный материала (16:9) на подключенном телевизоре формата 4:3.

Mac-адрес

Mac-адрес – это уникальное значение, присваиваемое сетевому устройству для его идентификации.

Pan Scan (PS 4:3)

Формат экрана, который отрезает боковые стороны изображения и позволяет просмотр широкоэкранный материала (16:9) на подключенном телевизоре формата 4:3.

x.v.Color

Функция x.v.Color позволяет воспроизводить большую цветовую гамму, чем ранее, выводя практически все цвета, воспринимаемые человеческим глазом.

Звук в формате Linear PCM

Linear PCM представляет собой формат записи сигнала, используемый для аудиодисков CD, а также некоторых дисков DVD и Blu-ray. Звук на аудиодисках CD записывается с частотой дискретизации 44,1 кГц и разрядностью 16 бит. (Звук записывается в диапазоне частот от 48 кГц с разрядностью 16-бит до 96 кГц с разрядностью 24 бита на дисках DVD и в диапазоне от 48 кГц с разрядностью 16 бит до 192 кГц с разрядностью 24 бит на дисках Blu-ray.)

Скрытые субтитры

Скрытые субтитры являются разновидностью субтитров, и разница между субтитрами и заголовками заключается в том, что субтитры предназначены для слышащих людей, а скрытые субтитры — для людей с нарушениями слуха. В субтитрах нечасто отображается все звучание. Например, субтитры показывают звуковые эффекты (например, телефонный звонок и шаги), в то время как они не отображены в субтитрах. Перед выбором данной настройки убедитесь, что на диске содержится информация закрытого заголовка.

Субтитры

Представляют собой строки текста, появляющиеся в нижней части экрана, которые используются для перевода или расшифровки диалога. Они записаны на многих дисках DVD и Blu-ray.

Цветовое пространство

Цветовое пространство — это воспроизводимый цветовой диапазон. RGB – это цветовое пространство на основе цветовой модели RGB (красный, зеленый и синий), которое обычно используется в компьютерных мониторах. YCbCr – это цветовое пространство на основе сигнала яркости (Y) и двух сигналов различия цвета (Cb и Cr).

Технические характеристики

■ Общая часть

Источник питания

[Модели для США и Канады]	120 В переменного тока, 60 Гц
[Модели для Европы, России и Австралии] 110–240 В переменного тока, 50 Гц
[Модель для Азии, Центральной и Южной Америки] 110–240 В переменного тока, 50/60 Гц
[Другие модели].....	110–240 В переменного тока, 60 Гц

Потребляемая мощность 19 Вт

Потребление электроэнергии в режиме ожидания

HDMI контроль Выкл, Режим Network Standby Выкл.....	0,2 Вт
HDMI контроль Вкл, Режим Network Standby Выкл.....	0,3 Вт
HDMI контроль Выкл, Режим Network Standby Вкл 5,3 Вт
Проводное соединение	5,0 Вт
Беспроводные.....	5,0 Вт
HDMI контроль Вкл, Режим Network Standby Вкл.....	5,3 Вт
Размеры (Ш Ч В Ч Г, включая выступы)	435 Ч 86 Ч 258 мм
Вес	2,9 кг

■ Аудиохарактеристики

Уровень выходного аудиосигнала (1 кГц, 0 дБ)

Blu-ray Disc/DVD/CD-DA..... 2 ± 0,3 В

Соотношение «сигнал/шум»

Blu-ray Disc/DVD/CD-DA..... 115 дБ

Динамический диапазон

Blu-ray Disc/DVD..... 110 дБ

CD-DA..... 100 дБ

Гармонические искажения (1 кГц)

Blu-ray Disc/DVD/CD-DA..... 0,002%

Частотная характеристика

Blu-ray Disc/DVD от 4 Гц до 22 кГц (частота дискретизации 48 кГц)
	4 Гц – 44 кГц (при частоте вывода сигнала 96 кГц)
CD-DA.....	от 4 Гц до 20 кГц

■ Входные/выходные терминалы

HDMI Выход.....Разъем типа А Ч 1
480i/576i/480p/576p/720p/1080i/1080p/1080p при 24 Гц,
Deep Color, поддержка x.v.

Цифровой выход..... Оптический Ч 1, коаксиальный Ч 1

Аналоговый аудиовыход..... Микшированный 2-канальный Ч 1

USB.....Разъем типа А Ч 2

Беспроводная сеть LAN.....Стандарт: IEEE 802.11 b/g/n

Частотный диапазон: 2,4 ГГц

Прочее оборудование Дистанционное управление IN/OUT Ч 1

RS-232 Ч 1 (для возможного использования)

Ethernet Ч 1

Технические характеристики могут изменяться без уведомления.

■ Авторское право

Примечание

– Аудиовизуальный материал может содержать работы, защищенные авторским правом, которые не должны записываться без разрешения владельца авторского права. Обратитесь к соответствующим законам вашей страны.



“Blu-ray Disc™”, “Blu-ray™”, “Blu-ray 3D™”, “BD-Live™”, “BONUSVIEW™” и

соответствующие логотипы являются товарными знаками Blu-ray Disc Association.



DVD является товарным знаком DVD Format/Logo Licensing Corporation.



Произведено по лицензии Dolby Laboratories. Dolby и символ в виде двух букв D являются торговыми марками Dolby Laboratories.



Произведено по лицензии по Патентам США №: 5,956,674; 5,974,380; 6,226,616; 6,487,535; 7,212,872; 7,333,929; 7,392,195; 7,272,567 и другим, выпущенным или ожидающим подтверждения патентам США и мировым патентам. DTS-HD, соответствующий символ, а также сочетание надписи DTS-HD и символа являются зарегистрированными товарными знаками, а DTS-HD Master Audio является товарным знаком DTS, Inc. Изделие включает программное обеспечение. © Корпорация DTS. Все права защищены.



“HDMI”, логотип “HDMI” и словосочетание High-Definition Multimedia Interface являются товарными знаками или зарегистрированными товарными знаками HDMI Licensing LLC в США и других странах.

x.v.Color™

“x.v.Color” и логотип “x.v.Color” являются товарными знаками Sony Corporation.



“AVCHD” и логотип “AVCHD” являются товарными Panasonic Corporation и Sony Corporation.

Продолжение на следующей странице. ➔

5

Дополнительная информация

Русский



Java является зарегистрированным товарным знаком компании Oracle и/или ее филиалов.



Bluetooth является зарегистрированным товарным знаком Bluetooth SIG.



DLNA™ и DLNA CERTIFIED™ являются товарными знаками или зарегистрированными товарными знаками Digital Living Network Alliance. Все права защищены. Несанкционированное использование строго запрещено.



Логотип Wi-Fi CERTIFIED является сертификационным знаком Wi-Fi Alliance. Идентификационный знак Wi-Fi Protected Setup принадлежит Wi-Fi Alliance. “Wi-Fi”, “Wi-Fi Protected Setup”, “Wi-Fi Direct” и “Miracast” являются знаками или зарегистрированными знаками Wi-Fi Alliance.

Данный продукт лицензирован по лицензии на пакет патентных лицензий AVC и пакета патентных лицензий VC-1 для личного некоммерческого пользования потребителем (i) кодирования видео в соответствии со стандартом AVC и стандартом VC-1 (“AVC/VC-1 Video”), и/или (ii) декодирования AVC/VC-1 Video, которое были закодировано потребителем, занимающимся личной некоммерческой деятельностью, и/или было приобретено у поставщика видеопродукции, имеющего лицензию на предоставление AVC/VC-1 Video. На использование в иных целях лицензия не предоставляется и не распространяется. Для получения дополнительных сведений обращайтесь в MPEG LA, LLC. См. <http://www.mpegla.com>.

Данный продукт лицензирован согласно одной из лицензий, входящих в портфолио MVC, для личного использования потребителем и других видов использования, при которых потребитель не получает оплату за выполнение следующих операций: (i) кодирование видеосигнала в соответствии со стандартом MVC (“видео в формате MVC”); (ii) декодирование видео в формате MVC, закодированного потребителем с целью личного использования и/или полученного от поставщика видеосодержимого, имеющего лицензию на предоставление видео в формате MVC. На использование в иных целях лицензия не предоставляется и не распространяется. Для получения дополнительных сведений обращайтесь в MPEG LA, LLC. См. <http://www.mpegla.com>

Windows Media Player является зарегистрированным товарным знаком корпорации Microsoft в США и/или других странах

© 2004–2012 гг. Verance Corporation. Cinavia® является товарным знаком Verance Corporation. Защищено патентом США 7369677 и другими выпущенными или ожидающими подтверждения мировыми патентами по лицензии компании Verance Corporation. Все права защищены.



DivX®, DivX Certified®, DivX Plus® HD и соответствующие логотипы являются товарными знаками Rovi Corporation или ее дочерних компаний и используются по лицензии. Проигрыватель имеет сертификацию DivX Certified® и позволяет воспроизводить видео в форматах DivX® и DivX Plus® HD (H.264/MKV) до 1080p HD, включая платное содержимое.

О ВИДЕОФОРМАТЕ DIVX: DivX® представляет собой цифровой формат видеоданных, созданный DivX, LLC, подразделением Rovi Corporation. Это устройство имеет маркировку DivX Certified®, что говорит о том, что оно прошло строгую проверку и должным образом воспроизводит видео формата DivX. На сайте divx.com представлена более подробная информация и программное обеспечение для преобразования файлов в видео формате DivX. О DIVX VIDEO-ON-DEMAND (ВИДЕО ПО ЗАПРОСУ): данное устройство DivX Certified® необходимо зарегистрировать, чтобы воспроизводить приобретенные видеоматериалы DivX Video-on-Demand (VOD). Для получения регистрационного кода найдите раздел “DivX VOD” в меню установок устройства. Перейдите на сайт vod.divx.com для получения более подробной информации о выполнении регистрации.

Указатель

■ ЧИСЛЕННЫЕ ЗНАЧЕНИЯ

2ch Downmix, меню SETUP	39
2ND AUDIO, пульт дистанционного управления	9
3D Выход, меню SETUP	37
■ А	
ANGLE, пульт дистанционного управления	9
AUDIO, пульт дистанционного управления	9
AV CONTROLLER	26
A/V, пульт дистанционного управления	9
■ В	
BD-Live	30
BD-Live соединения, меню SETUP	36
Bluetooth	24
■ С	
CLEAR, пульт дистанционного управления	8
Code Page, экранное меню	27
■ D	
Digital Media Controller (DMC)	16
DivX (R) VOD DRM, меню SETUP	35
DLNA	16
DRC контроль динамического диапазона, меню SETUP	38
Dropbox	23
■ E	
ENTER, пульт дистанционного управления	9
■ H	
HDMI 1080p 24Hz, меню SETUP	38
HDMI Deep Color, меню SETUP	38
HDMI Выход	39
HDMI контроль, меню SETUP	34
HDMI, меню SETUP	38
HOME, пульт дистанционного управления	9
■ M	
Miracast	26
■ O	
ON SCREEN, пульт дистанционного управления	10
■ P	
PBC (настройка нажатием кнопки)	36
Picasa Веб-альбомы	23
PIN-код (WPS)	36
PIP метка, меню SETUP	35
PIP, пульт дистанционного управления	8
POP UP/MENU, пульт дистанционного управления	10
PROGRAM, пульт дистанционного управления	8
PURE DIRECT	10
■ R	
REPEAT, пульт дистанционного управления	8
RETURN, пульт дистанционного управления	9
■ S	
SACD Выходной, меню SETUP	39
SEARCH, пульт дистанционного управления	9
SETUP, пульт дистанционного управления	9
SHUFFLE, пульт дистанционного управления	8
STATUS, пульт дистанционного управления	9

SUBTITLE, пульт дистанционного управления	9
■ T	
TOP MENU, пульт дистанционного управления	9
■ W	
WPS (Настройка защиты Wi-Fi)	36
■ Y	
YouTube	23
■ Z	
ZOOM, пульт дистанционного управления	8
■ А	
Авто режим ожид., меню SETUP	34
Автоматическое воспроизведение дисков, меню SETUP	35
Аудиовыход, меню SETUP	38
Аудио, меню SETUP	34
Аудио, экранное меню	27
■ Б	
Безопасность, меню SETUP	35
Битрейт, экранное меню	27
■ В	
Видео обработка, меню SETUP	38
Воспроизведение диска с данными	20
Воспроизведение содержимого носителя USB	20
Воспроизведение, меню SETUP	35
Время, экранное меню	27
Вторичное аудио, экранное меню	27
Вторичное видео, экранное меню	27
Выполнение операций с помощью меню SETUP	33
■ Г	
Глава, экранное меню	27
■ Д	
Дискретизация, меню SETUP	38
Дистанционное управление	8
Другие подключения	18
■ З	
Заголовков, экранное меню	27
Загрузка исходных параметров, меню SETUP	34
Запоминающее устройство, меню SETUP	34
■ И	
Изменение пароля, меню SETUP	35
Информация о системе, меню SETUP	39
Информация, меню SETUP	36
■ К	
Кнопки управления курсором, пульт дистанционного управления	9
Кнопки управления, пульт дистанционного управления	9
Коаксиальный / Оптический, меню SETUP	38
Код страны, меню SETUP	35
■ M	
Мгновенный Повтор, экранное меню	27
Мгновенный Поиск, экранное меню	27
Меню SETUP	31
Меню диска, меню SETUP	34
Меню состояния	28
Метка вторичного аудио, меню SETUP	35
Микширование, меню SETUP	39
■ H	
Настройка IP, меню SETUP	36

Настройка дисплея, меню SETUP	37
Настройка звука, меню SETUP	38
Настройка соединения, меню SETUP	36
Настройки прокси-сервера, меню SETUP	36
■ O	
Обновление программного обеспечения	42
Обновление программного обеспечения, меню SETUP	34
Обновление уведомлений	34
Общие установки, меню SETUP	34
■ П	
Перемещение, экранное меню	27
Последняя память, меню SETUP	35
Пост-обработки, меню SETUP	39
Приоритет вывода сигнала	39
Проверка соединения, меню УСТАНОВКИ	36
Программное воспроизведение	29
Простая установка, меню SETUP	34
■ P	
Режим деинтерлейсинга, меню SETUP	38
Режим/Режим воспроизведения, экранное меню	27
Родительский контроль, меню SETUP	35
■ С	
Сеть, меню SETUP	36
Система, меню SETUP	34
Скрытые субтитры, меню SETUP	38
Слайд-шоу, экранное меню	27
Сообщение о 3D воспроизведении, меню SETUP	34
Стиль субтитров, экранное меню	27
Субтитры, меню SETUP	35
Субтитры, экранное меню	27
■ T	
ТВ система, меню SETUP	37
ТВ экран, меню SETUP	37
ТВ, меню SETUP	37
Трек/Файл, экранное меню	27
■ У	
Угловая метка, меню SETUP	35
Угол обзора, экранное меню	27
Управление по сети, меню SETUP	36
Установки колонок, меню SETUP	39
■ Ф	
Форматы аудиовыходов	40
Форматы видеовыходов	41
Функция поиска	29
Функция "HDMI контроль"	34
Функция "Картинка в картинке"	30
■ Ц	
Цветные кнопки, пульт дистанционного управления	8
Цветовое пространство, меню SETUP	37
Цифровые кнопки, пульт дистанционного управления	8
■ Ш	
Шумоподавление, меню SETUP	38
■ Э	
Экранное меню	27
Экранное меню, меню SETUP	34
■ Я	
Язык, меню SETUP	34

Caution: Read this before operating your unit.

- 1 To assure the finest performance, please read this manual carefully. Keep it in a safe place for future reference.
- 2 Install this sound system in a well ventilated, cool, dry, clean place-away from direct sunlight, heat sources, vibration, dust, moisture, and/or cold. For proper ventilation, allow the following minimum clearances.
Top : 10 cm (4 in)
Rear: 10 cm (4 in)
Side: 10 cm (4 in)
- 3 Locate this unit away from other electrical appliances, motors, or transformers to avoid humming sounds.
- 4 Do not expose this unit to sudden temperature changes from cold to hot, and do not locate this unit in an environment with high humidity (i.e. a room with a humidifier) to prevent condensation inside this unit, which may cause an electrical shock, fire, damage to this unit, and/or personal injury.
- 5 Avoid installing this unit where foreign object may fall onto this unit and/or this unit may be exposed to liquid dripping or splashing. On the top of this unit, do not place:
 - Other components, as they may cause damage and/or discoloration on the surface of this unit.
 - Burning objects (i.e. candles), as they may cause fire, damage to this unit, and/or personal injury.
 - Containers with liquid in them, as they may fall and liquid may cause electrical shock to the user and/or damage to this unit.
- 6 Do not cover this unit with a newspaper, tablecloth, curtain, etc. in order not to obstruct heat radiation. If the temperature inside this unit rises, it may cause fire, damage to this unit, and/or personal injury.
- 7 Do not plug in this unit to a wall outlet until all connections are complete.
- 8 Do not operate this unit upside-down. It may overheat, possibly causing damage.
- 9 Do not use force on switches, knobs and/or cords.
- 10 When disconnecting the power cable from the wall outlet, grasp the plug; do not pull the cable.
- 11 Do not clean this unit with chemical solvents; this might damage the finish. Use a clean, dry cloth.
- 12 Only voltage specified on this unit must be used. Using this unit with a higher voltage than specified is dangerous and may cause fire, damage to this unit, and/or personal injury. Yamaha will not be held responsible for any damage resulting from use of this unit with a voltage other than specified.
- 13 To prevent damage by lightning, keep the power cable disconnected from a wall outlet or this unit during a lightning storm.
- 14 Do not attempt to modify or fix this unit. Contact qualified Yamaha service personnel when any service is needed. The cabinet should never be opened for any reasons.
- 15 When not planning to use this unit for long periods of time (i.e. vacation), disconnect the AC power plug from the wall outlet.
- 16 Be sure to read the “Troubleshooting” section on common operating errors before concluding that this unit is faulty.
- 17 Before moving this unit, press  to set this unit to the standby mode, and disconnect the AC power plug from the wall outlet.
- 18 Condensation will form when the surrounding temperature changes suddenly. Disconnect the power cable from the outlet, then leave this unit alone.
- 19 When using this unit for a long time, this unit may become warm. Turn the power off, then leave this unit alone for cooling.
- 20 Install this unit near the AC outlet and where the AC power plug can be reached easily.
- 21 The batteries shall not be exposed to excessive heat such as sunshine, fire or the like.

Do not use this unit within 22 cm (9 inches) of persons with a heart pacemaker implant or defibrillator implant.

This unit is not disconnected from the AC power source as long as it is connected to the wall outlet, even if this unit itself is turned off by . This state is called the standby mode. In this state, this unit is designed to consume a very small quantity of power.

Where the mains plug or an appliance coupler is used as the disconnect device, the disconnect device shall remain readily operable.

WARNING
TO REDUCE THE RISK OF FIRE OR ELECTRIC SHOCK, DO NOT EXPOSE THIS UNIT TO RAIN OR MOISTURE.

The laser component in this product is capable of emitting radiation exceeding the limit for Class 1.

1. Introduction

What you can do with this Player	2
Wide variety of supported discs and file formats	2
Enhanced network features	2
Easy setup and operations	2
High-quality audio features	2
Supplied parts	2
About discs and files	3
Types of discs/files that can be used with this Player	3
Loading a disc	4
Disc precautions	5
Notice for watching 3D video images	5
Cinavia technology	5
Controls and functions	6
Front panel	6
Rear panel	7
Remote control	8

2. Connection

Video/audio connections	12
Connecting to a TV via an AV receiver	13
Connecting to a TV directly	13
Connecting to a TV and audio equipment	14
Network connection	15
Wireless connection	15
Wired connection	15
DLNA server setup	16
USB connection	17
Other connections	18
Connecting to the REMOTE CONTROL jacks	18
Connecting the power cable	18

3. Playback

Initial settings	19
Setting with the Easy Setup	19
Wireless connection setting	19
HOME menu	20
Playing back photo/music/video	20
Using network services	22
About Dropbox™	23
About Picasa™ Web Albums	23
About YouTube™	23
Enjoying music via Bluetooth®	24
Pairing a Bluetooth device with this Player	24
Playing back Bluetooth device contents	25
Enjoying smartphone pictures and videos on the TV screen (Miracast™)	26
Operating this Player from mobile devices (AV CONTROLLER)	26
Advanced playback operation	27
On Screen menu	27
Status menu	28
Program play	29
Using Search	29
Enjoying BONUSVIEW™ and BD-Live™	29
Using Picture in Picture function (secondary audio/video playback)	30
Using the feature of BD-Live™	30

4. Settings

SETUP menu	31
Example of SETUP menu operation	33
General Setting	34
Display Setting	37
Audio Setting	38
System Information	39

About the audio output formats	40
About the HDMI video output formats	41
Software upgrade	42
Upgrading the software	42

5. Additional information

Troubleshooting	43
Power	43
Basic operation	43
Disc playback	43
Picture	44
Sound	44
Network	45
Bluetooth	46
Messages on the screen	46
Glossary	47
Specifications	49
General	49
Audio performance	49
Input/output	49
Copyright	49
Index	51

(at the end of this manual)

Information about third party software licenses...

New software that provides additional features or product improvements will be released as needed. We recommend upgrading the software of this Player to the latest version periodically. For details, refer to “Software upgrade” (p. 42).

■ About this manual

- This manual describes how to operate this Player using a remote control except when it is not available. Some of these operations are also available using the front panel buttons.
- Notes contain important information about safety and operating instructions. Hint(s) indicates a tip for your operation.
- This manual is printed prior to production. Design and specifications are subject to change in part as a result of improvements, etc. In case of differences between the manual and the product, the product has priority.

The icons used in this manual

Icons are used to indicate available buttons/functions for a particular format. For details on playable discs and formats, see page 3.

BD : BD-Video

DVD : DVD-Video, DVD-VR, DVD+VR, DVD-Audio

CD : Audio CD, Super Audio CD

VIDEO : Video files

MUSIC : Audio files

PHOTO : Photo files

What you can do with this Player

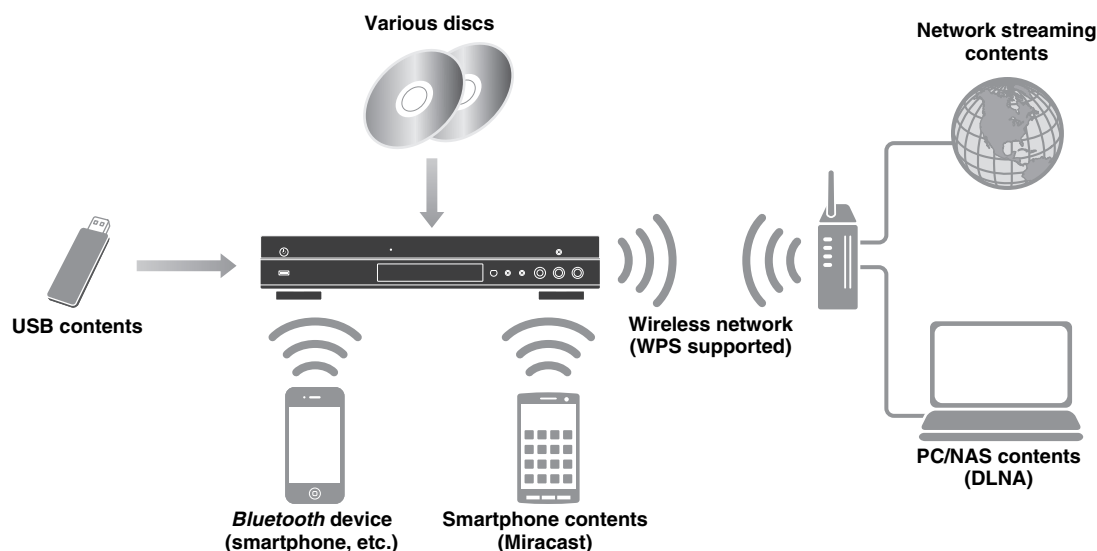

■ Wide variety of supported discs and file formats

- Blu-ray Disc™, DVDs, SA-CDs and CDs (p. 27)
- Blu-ray 3D™ (p. 12), BONUSVIEW™ and BD-Live™ (p. 29)
- Video, music and photo files on DVD-R/RW discs, CD-R/RW discs and USB memory devices (p. 20)

■ Enhanced network features

- Enjoying DLNA server (PC or NAS) contents (p. 20)
- Enjoying streaming contents on the network services (p. 22)
- Enjoying music via *Bluetooth*® (p. 24)
- Operating this player from mobile devices (AV CONTROLLER) via network (p. 26)
- Enjoying smartphone pictures and videos on the TV screen (Miracast™) (p. 26)

■ Easy setup and operations

- Quick and easy initial setup (p. 19)
- Automatic wireless setup with the WPS (Wi-Fi Protected Setup) (p. 19)
- Software upgrade via network or USB (p. 42)
- Sequential operations of the TV, AV receiver and this Player (HDMI Control) (p. 34)

■ High-quality audio features

- Up to 192-kHz/24-bit audio supported (p. 3)
- DSD and PCM output for SA-CD playback (p. 4)
- DVD-Audio supported (p. 3)

Supplied parts

Make sure the following accessories are provided with the product.

Remote control



Batteries (x2)
(AAA, R03, UM-4)

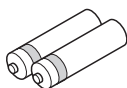

Power cable

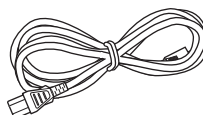

Types of discs/files that can be used with this Player

- 12 cm (5") and 8 cm (3") discs can be played back in this Player. Do not use an 8 cm (3") to 12 cm (5") adapter.
- Use discs that conform to compatible standards as indicated by the presence of official logos on the disc label. Playback of discs not complying with these standards is not guaranteed. In addition, the image quality or sound quality is not guaranteed even if the discs can be played back.

Media Type	Recording Format
BD-ROM/BD-R/ BD-RE	BD-Video/Data files
DVD-ROM	DVD-Video/DVD-Audio
DVD-R/DVD-R DL/DVD-RW	DVD-Video/DVD-VR/AVCHD/Data files
DVD+R/DVD+R DL/DVD+RW	DVD-Video/DVD+VR/AVCHD/Data files
CD-ROM	CDDA/HDCD
CD-R/CD-RW	CDDA/Data files
SA-CD	SA-CD
USB*	Data files
DLNA	Data files

* This Player is compatible with a USB memory device formatted with FAT 16/32 and NTFS.

Playable audio file formats MUSIC	Playable video file formats VIDEO	Playable photo file formats PHOTO
MP3 (.mp3) *1 WMA (.wma) *2 AAC (.aac/m4a) WAV (.wav) *3 FLAC (.flac) *3 ALAC (.m4a) *3	DivX (.divx) MKV with DivX format (.mkv) MKV with H.264 (.mkv) MPEG PS (.mpeg/.mpg) MPEG TS (.ts) MPEG-4 (.mp4) VOB (.vob) AVI (.avi) ASF (.asf) WMV (.wmv) *4	JPEG (.jpeg/.jpg) GIF (.gif) PNG (.png)

*1 Sampling frequency within 32-48 kHz (Stereo) and bitrate within 8-320 kbps

*2 Sampling frequency within 32-48 kHz (Stereo) and bitrate within 32-192 kbps

*3 Sampling frequency of up to 192 kHz/24 bit (LPCM/ Stereo)











*4 WMV9 (maximum resolution: 1,920 x 1,080)







Notes

- Playback of a file listed in the chart above is not guaranteed depending on methods of file creation or codecs used.
- Playback of all files on the disc, USB memory device and network is not guaranteed.
- A copyright protected file cannot be played back.
- When using DLNA, a file needs to meet the DLNA sever requirement.

Region management information for Blu-ray Disc/DVD videos

- Blu-ray Disc/DVD video players and discs have region codes, which dictate the regions in which a disc can be played. Verify the region code mark on the rear panel of this Player.
- For a Blu-ray Disc, the disc can be played back on this Player with the same region code mark, or the region code "ABC" mark.
- For a DVD disc, the disc can be played back on this Player with the same region code mark, or the region code "ALL" mark.

Region management information		
Destination	BD-Video	DVD-Video
U.S.A. and Canada	Region code "A" or "ABC" 	Region number "1" or "ALL" 
Europe	Region code "B" or "ABC" 	Region number "2" or "ALL" 
Asia and Taiwan	Region code "A" or "ABC" 	Region number "3" or "ALL" 
Central and South America	Region code "A" or "ABC" 	Region number "4" or "ALL" 
Australia	Region code "B" or "ABC" 	Region number "4" or "ALL" 

Region management information		
Destination	BD-Video	DVD-Video
Russia	Region code "C" or "ABC"    	Region number "5" or "ALL"  

Notes

- Blu-ray Disc/DVD video operations and functions may be different from the explanations in this manual and some operations may be prohibited due to disc manufacturer's settings.
- If a menu screen or operating instructions are displayed during playback of a disc, follow the operating procedure displayed.
- Playback for some of the discs may not be possible depending on the disc.
- Finalize all recording media that is played back in this Player.
- "Finalize" refers to a recorder processing a recorded disc so that it will play in other players/recorders as well as this Player. Only finalized discs can be played back in this Player. (This Player does not have a function to finalize discs.)

About Super Audio CD (SA-CD)

- Audio format based upon the current CD standards but includes a greater amount of information that provides higher quality sound. There are three types of discs: single layer, dual layer and hybrid discs. The hybrid disc can be played on existing CD players as well as Super Audio CD players since it contains both standard audio CD and Super Audio CD information.

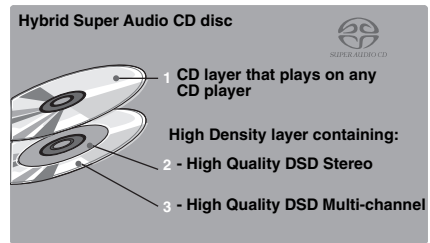
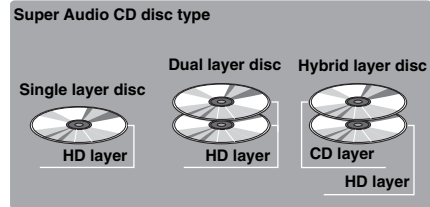

Hint

- You can select the output audio signals from DSD or PCM (p. 39).

Note

- This unit does not show the text data included in the discs on the front panel display.

Loading a disc

- Insert the disc with the label facing up.
- In case of the disc recorded on both sides, face down the side to play back.

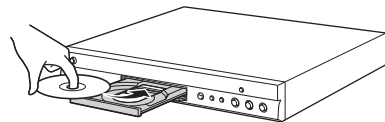

Notes





- Playback may begin automatically, depending on the disc and setting of this Player.
- The menu may be displayed first, depending on the disc.
- The disc load time may vary depending on the disc.

■ Disc precautions

Be careful of scratches and dust

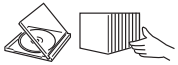
- Blu-ray Disc, DVD and CD discs are sensitive to dust, fingerprints and especially scratches. A scratched disc may not be able to be played back. Handle discs with care and store them in a safe place.

Proper disc storage

Place the disc in the center of the disc case and store the case and disc upright.	
Avoid storing discs in locations subject to direct sunlight, close to heating appliances or in locations of high humidity.	
Do not drop discs or subject them to strong vibrations or impacts.	
Avoid storing discs in locations where there are large amounts of dust or moisture.	

Handling precautions



- If the surface is soiled, wipe gently with a soft, damp (water only) cloth. When wiping discs, always move the cloth from the center hole toward the outer edge.
- Do not use record cleaning sprays, benzene, thinner, static electricity prevention liquids or any other solvent.
- Do not touch the surface.
- Do not stick paper or adhesive labels to the disc.
- If the playing surface of a disc is soiled or scratched, the Player may decide that the disc is incompatible and eject the disc tray, or it may fail to play the disc correctly. Wipe any dirt off the playing surface with a soft cloth.

Cleaning the pick up lens

- Never use commercially available cleaning discs. The use of these discs can damage the lens.
- Request the nearest service center approved by Yamaha to clean the lens.

■ Notice for watching 3D video images

- Some people may experience discomfort (such as eye strain, fatigue, or nausea) while watching 3D video images. We recommend that all viewers take regular breaks while watching 3D video images.
- If you experience any discomfort, stop watching the 3D video images until the discomfort subsides. Consult a doctor if you experience severe discomfort.
- Read the owner's manuals (Blu-ray Disc and TV) and/or the caution messages that appear on the TV carefully.
- The vision of young children (especially those under six years old) is still under development. Consult your doctor (such as a pediatrician or eye doctor) before allowing young children to watch 3D video images.
- Adults should supervise young children to ensure they follow the recommendations described above.

■ Cinavia technology

- Cinavia technology is a part of the content protection system included in your Blu-ray Disc Player.

Note

- The following messages may be displayed and playback stopped or audio outputs temporarily muted by your Blu-ray Disc player if you are playing an unauthorized copy of content that is protected by Cinavia technology.

These messages are displayed in English only.

Playback stopped. The content being played is protected by Cinavia® and is not authorized for playback on this device.
For more information, see <http://www.cinavia.com>.
Message Code 1.

Audio outputs temporarily muted. Do not adjust the playback volume. The content being played is protected by Cinavia® and is not authorized for playback on this device.
For more information, see <http://www.cinavia.com>.
Message Code 3.

Cinavia Notice

This product uses Cinavia technology to limit the use of unauthorized copies of some commercially-produced film and videos and their soundtracks. When a prohibited use of an unauthorized copy is detected, a message will be displayed and playback or copying will be interrupted. More information about Cinavia technology is provided at the Cinavia Online Consumer Information Center at <http://www.cinavia.com>. To request additional information about Cinavia by mail, send a postcard with your mailing address to: Cinavia Consumer Information Center, P.O. Box 86851, San Diego, CA, 92138, USA.

Controls and functions

■ Front panel

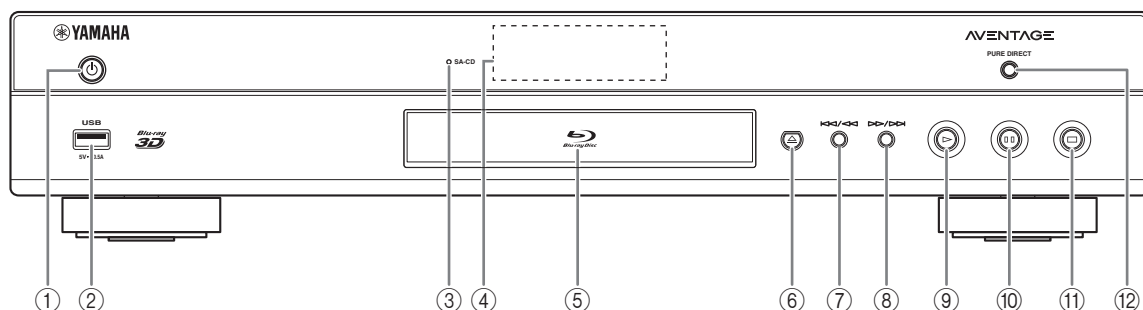

- ① **⏻ (On/Standby)**
Turns this Player on/Sets to standby mode.
Press and hold **⏻** on the front panel for more than 5 seconds to reset this Player (system reset).
- ② **USB connector (p. 17)**
- ③ **SA-CD indicator**
Lights up when an SA-CD is loaded and the SA-CD layer (p. 4) is selected.
- ④ **Front panel display**
Displays various information for operational status.
- ⑤ **Disc tray door**
- ⑥ **▲ (Eject)**
Opens/Closes the disc tray.
- ⑦ **⏮/⏪ (Search backward/Skip backward)**
Press to skip backward, and press and hold to search backward.
- ⑧ **⏩/⏭ (Search forward/Skip forward)**
Press to skip forward, and press and hold to search forward.
- ⑨ **▶ (Play)**
Starts a playback.
- ⏸ **(Pause)**
Pauses a playback.
- ⏹ **(Stop)**
Stops a playback.
- ⑫ **PURE DIRECT**
Press to change the Pure Direct mode (p. 10).
This button lights up when Pure Direct is enabled.

Note

- Remove the protective film from the front panel before operating the Player.

■ Rear panel

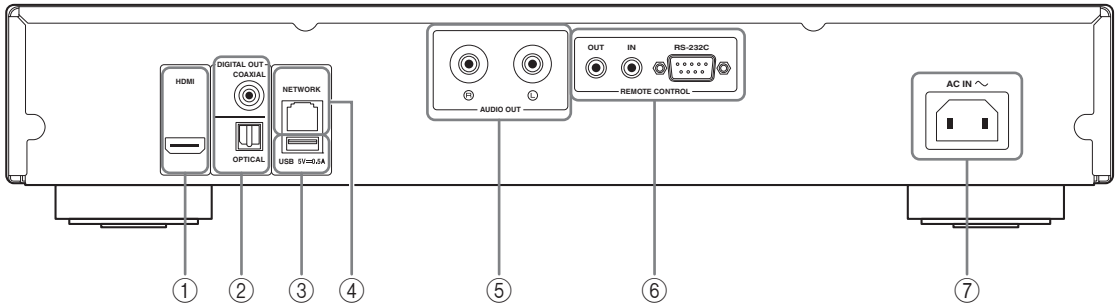





- ① **HDMI** (p. 12)
- ② **DIGITAL OUT (COAXIAL/OPTICAL)** (p. 14)
- ③ **USB** (p. 17)
- ④ **NETWORK** (p. 15)
- ⑤ **AUDIO OUT (L/R)** (p. 14)
- ⑥ **REMOTE CONTROL (OUT/IN/RS-232C)** (p. 18)
- ⑦ **AC IN** (p. 18)

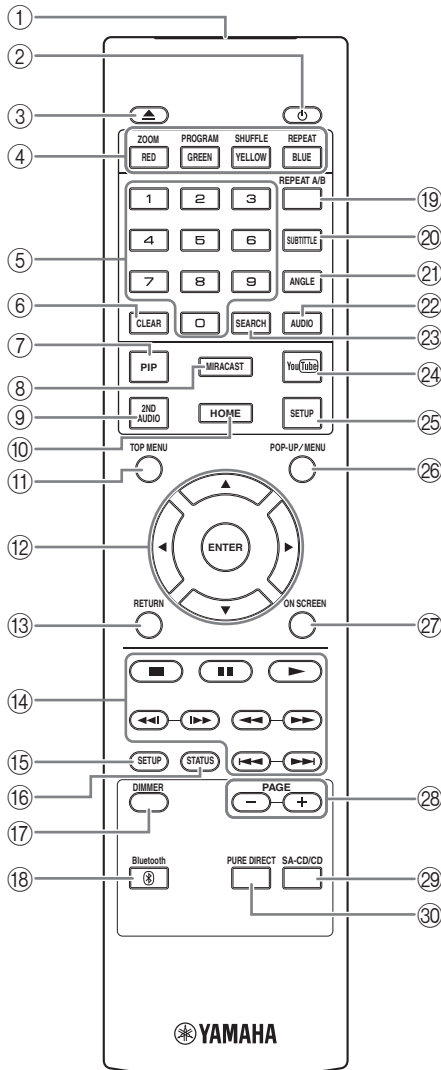

Remote control



Note





-  will appear on the top left corner of the screen when the pressed button is not available.



- ① **Infrared signal transmitter:** Outputs infrared signal. Aim this window to the remote control sensor (p. 11).
- ② : Turns this Player on or sets it to standby mode.
- ③ : Opens/closes the disc tray.
- ④ **Color buttons **: Use these buttons according to on-screen instructions.

ZOOM   : Zooms in/out. The size of the screen will change each time you press the button (zoom in/out: 3 steps each).

PROGRAM  : Sets the order of playback (p. 29). You can set up to 15 tracks (for an audio disc) or titles/chapters (DVD-Video).

SHUFFLE     : Selects shuffle play mode (p. 27).

REPEAT     

: Changes repeat mode. Repeat mode shown below will change each time you press the button.



: Repeats the title being played back.

: Repeats the chapter being played back.

: Repeats the folder being played back.

: Repeats all tracks/files on the disc.

: Repeats the track/file being played back.

- ⑤ **Number buttons:** Enters numbers, or during playback, jumps to the track/chapter corresponding to the number you input. These buttons may not be available depending on the disc type and playback condition.
- ⑥ **CLEAR:** Clears entered number/set item.
- ⑦ **PIP **: Turns on/off the Picture in Picture (p. 30). PIP Mark () is displayed on the screen when this function is available. You can also select this item from On Screen menu (p. 27).

Note





- PIP Mark is displayed only when the PIP Mark is set to on (p. 35).

- ⑧ **MIRACAST:** Starts Miracast (p. 26).

- ⑨ **2ND AUDIO** **BD**: Selects the secondary audio of the Picture in Picture (p. 30) or audio commentaries. The Secondary Audio Mark () is displayed on the screen when this function is available (p. 38). You can also select this item from On Screen menu (p. 27).

Note

- Secondary Audio Mark is displayed only when Secondary Audio Mark is set to on (p. 35).

- ⑩ **HOME**: Displays the HOME menu screen (p. 20).
- ⑪ **TOP MENU** **BD** **DVD**: Displays the top menu screen if the disc contains a menu. Select the desired item using /// and **ENTER**.

Note

- Specific operations may be different depending on the disc. Follow the instructions of each menu screen.

- ⑫ **Cursor buttons** (///): Moves the focus in the menu screen.

ENTER: Selects the focused menu/item.

- ⑬ **RETURN**: Returns to the previous menu or screen, etc.



- ⑭ **Control buttons**

BD **DVD** **CD** **VIDEO** **MUSIC** **PHOTO**

: Stops playback.

: Pauses playback.

: Plays back contents.

/: Skips backward/forward.

/

BD **DVD** **CD** **VIDEO** **MUSIC**:

Searches backward/forward. The search speed will change each time you press the button (search backward/forward: 5 steps each). Press  to resume normal playback.

PHOTO: Changes the speed of a slide show (slower/faster: 3 steps).

/

BD **DVD** **CD** **VIDEO** **MUSIC**:

Press for instant search/replay. Instant search skips the content 30 seconds. Instant replay replays the content from 10 seconds before.

- ⑮ **SETUP**: Displays SETUP menu screen (p. 31).

- ⑯ **STATUS**: Displays the playback information (p. 28).

- ⑰ **DIMMER**: Changes the brightness of the front panel display in four steps.

- ⑱ **Bluetooth**: Starts *Bluetooth* (p. 24).

- ⑲ **REPEAT A/B** **BD** **DVD** **CD** **VIDEO** **MUSIC**: Plays back a specific part you want to repeat.

1 Press **REPEAT A/B** at the scene where you want to set the start point. “A-” is displayed on the screen.

2 Press **REPEAT A/B** again at the scene where you want to set the end point. “A-B” is displayed on the screen. Repeat playback starts.

3 To cancel the repeat playback, press **REPEAT A/B**. “A-B” disappears and the repeat playback is finished.

Note

- This function cannot be performed depending on the specifications of the disc.

- ⑳ **SUBTITLE** **BD** **DVD** **VIDEO**: Changes subtitle languages (p. 48) if available. You can also select this item from On Screen menu (p. 27).

- ㉑ **ANGLE** **BD** **DVD**: Changes the camera angle if video is recorded with multiple angles. The Angle Mark () is displayed on the screen when this function is available. You can also select this item from On Screen menu (p. 27).

Note

- Angle Mark is displayed only when the Angle Mark is set to on (p. 35).

- ㉒ **AUDIO** **BD** **DVD** **VIDEO**: Changes the audio language or format. You can also select this item from On Screen menu (p. 27).

- ㉓ **SEARCH** **BD** **DVD** **CD** **VIDEO** **MUSIC**: Jumps to a specified point during playback. For details on this function, refer to “Using Search” (p. 29). You can also select this item from status menu (p. 28).

- ㉔ **YouTube**: Starts YouTube (p. 23).

- ㉕ **SETUP**: Displays SETUP menu screen (p. 31).

Continued to the next page. →

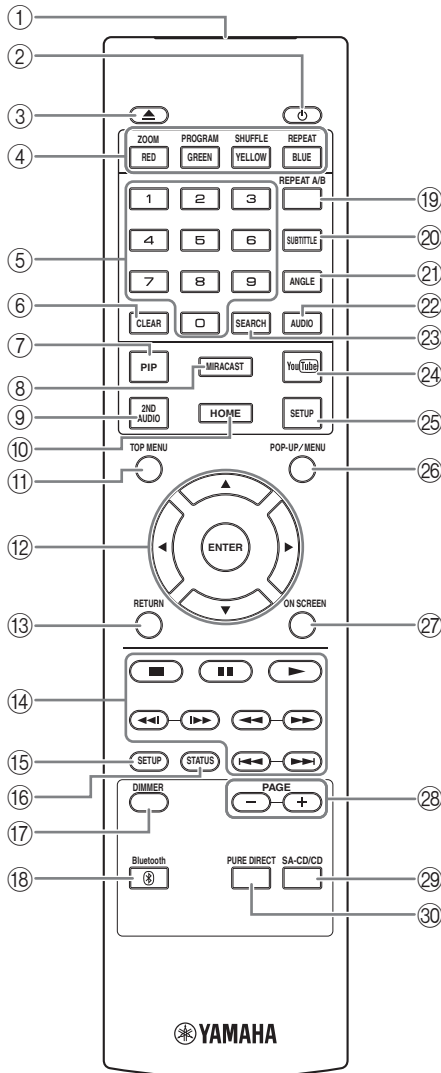

②⑥ **POP-UP/MENU** **BD** **DVD** : Displays pop-up menu. The menu contents displayed vary depending on the disc. For details on how to see and operate the pop-up menu, refer to the manual for the disc. The top menu screen may be displayed by pressing **POP-UP/MENU** depending on the DVD.

②⑦ **ON SCREEN**: Displays On Screen menu (p. 27).

②⑧ **PAGE (+/-)** **DVD** : Moves to a previous/next page when a DVD-Audio disc including the slide show or page turn feature is played.

Note

– This function may not be performed depending on the content of the disc.

②⑨ **SA-CD/CD**: Selects the layer to be played when an SA-CD/CD hybrid disc (p. 4) is played back.

Hint

– The SA-CD indicator (p. 6) on the front panel lights up when an SA-CD is loaded and the SA-CD layer is selected.

Notes

– This operation is available only when no disc is loaded.

– Audio signals are not output from the COAXIAL or OPTICAL jack when the SA-CD layer is selected.

③⑩ **PURE DIRECT**: Switches between the following Pure Direct modes.

Mode 1: Enables Pure Direct with turning off the front panel display and disabling HDMI video outputs. This mode is suitable for listening audio with high quality sound.

Mode 2: Enables Pure Direct with turning off the front panel display. This mode is suitable for watching movies with high quality sound.

Off: Disables Pure Direct.

Hint

– The PURE DIRECT button (p. 6) on the front panel lights up when Pure Direct is enabled.

Loading the batteries in the remote control

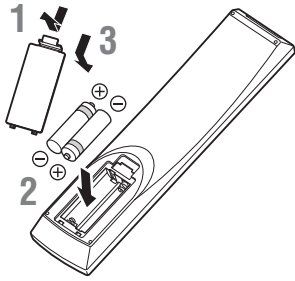

Notes

- Change both batteries when the operation range of the remote control decreases.
- Use AAA, R03, UM-4 batteries.
- Make sure that the polarities are correct. Refer to the illustration inside the battery compartment.
- Remove the batteries if the remote control is not to be used for an extended period of time.
- Do not use old batteries together with new ones.
- Do not use different types of batteries (such as alkaline and manganese batteries) together. Read the packaging carefully as these different types of batteries may have the same shape and color.
- If the batteries have leaked, dispose of them immediately. Avoid touching the leaked material or letting it come into contact with clothing, etc. Clean the battery compartment thoroughly before installing new batteries.
- Do not throw away batteries with general house waste; dispose of them correctly in accordance with your local regulations.
- Keep batteries away from children. If a battery is accidentally swallowed, contact your doctor immediately.
- When not planning to use the remote control for long periods of time, remove the batteries from the remote control.
- Do not charge or disassemble the supplied batteries.

Approximate operating range of remote control

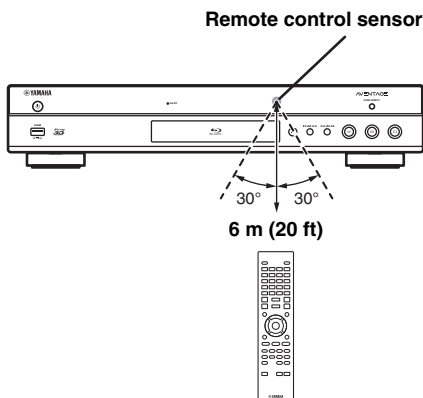

ID function

When using multiple Yamaha products, the remote control may work on another Yamaha product or another remote control may work on this Player. In this case, change the remote control ID to prevent unwanted operation. If you have changed the remote control ID, make sure that you select the same ID for the main unit. The default setting is ID1.

1 Remote control setting

To change the ID from ID1 to ID2, press and hold the red color button and **2** of number button simultaneously for 7 seconds. To change the ID from ID2 to ID1, press and hold the red color button and **1** of number button simultaneously for 7 seconds.

2 Main unit setting

Press and hold **◀◀/◀◀** and **▶▶/▶▶** on the front panel simultaneously for 2 seconds to display current ID when:

- No disc is inserted in this Player.
- The disc tray is closed.
- Playback is stopped.
- “NO DISC” is displayed on the front panel display.

Keep pressing and holding the keys for another 2 seconds to change the ID between ID1 and ID2.

Notes

- If the remote control is without batteries for a few minutes or if exhausted batteries remain in the remote control, the remote control ID is automatically set to ID1. If you want to use the remote control in ID2 setting, install new batteries and set the remote control ID again.
- When this Player is reset, its remote control ID will be ID1.

Video/audio connections

Make the corresponding video/audio cable connections depending on the equipment you want to use.

Hints

- See page 40 for information on the audio/video output formats.
- Prepare commercially available cables required for connections. The type and number of cables you need vary depending on the equipment to be connected.

Enjoying video/audio using a TV and an AV receiver

Refer to “Connecting to a TV via an AV receiver” (p. 13).

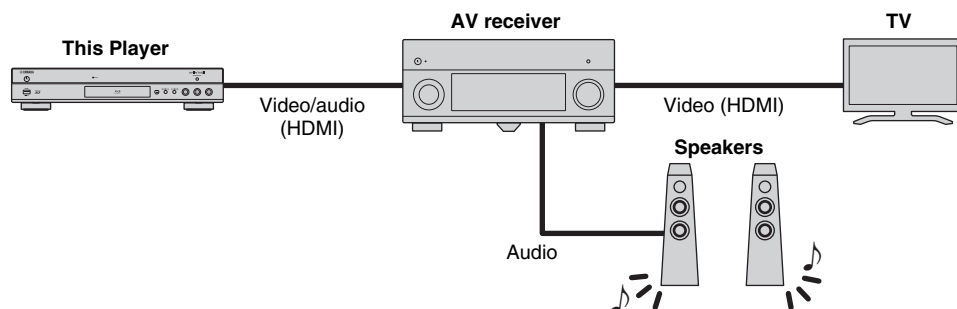

Enjoying video/audio using only a TV

Refer to “Connecting to a TV directly” (p. 13).



Enjoying video/audio using a TV and audio equipment

Refer to “Connecting to a TV and audio equipment” (p. 14).

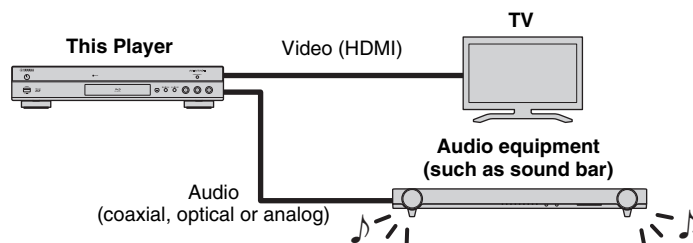

About HDMI

To enjoy high quality video and digital sound through the HDMI terminal, use commercially available HIGH SPEED HDMI cables that have the HDMI logo (as shown on the back cover).

Hints

- For information on the HDMI Control function, refer to “HDMI Control” (p. 34).
- To change the output mode of HDMI terminal, configure “HDMI” (p. 38) in Audio Setting.

Connection for the playback of Blu-ray 3D Discs

To enjoy Blu-ray 3D Discs on this Player, your system must meet the following conditions.

- Your TV and AV receiver (if available) must support the 3D feature.
- 3D Output in Display Setting (p. 37) is set to “Auto”.

■ Connecting to a TV via an AV receiver

Connect this Player to the AV receiver and the AV receiver to the TV with HDMI cables. For details on speaker connections, refer to the owner's manuals of the AV receiver and speakers.

Caution!

Do not connect the power cable of this Player until all connections are completed.

This Player

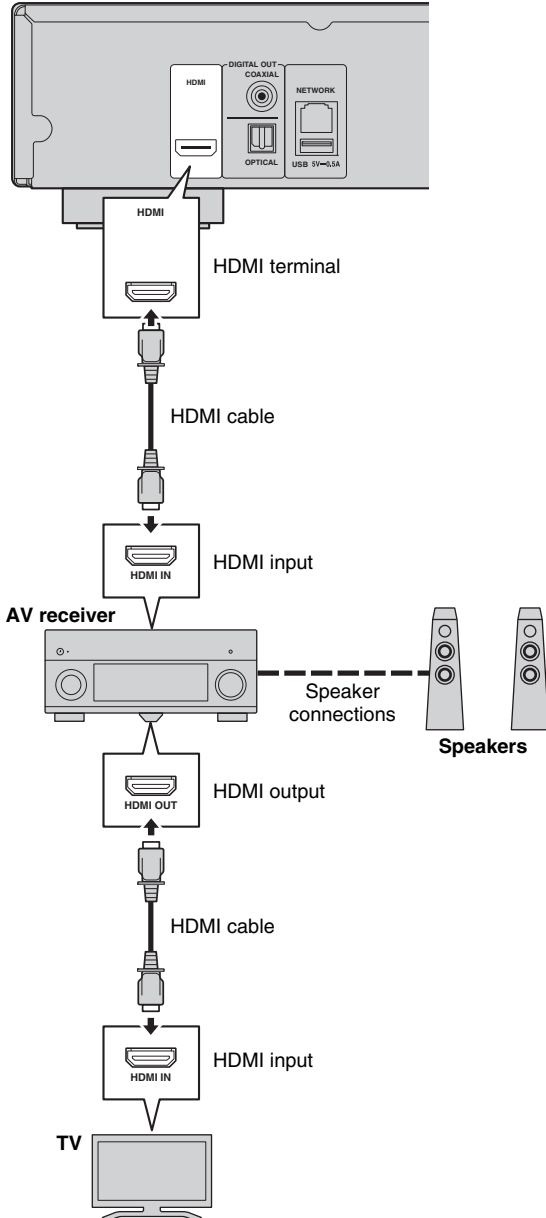

■ Connecting to a TV directly

Connect this Player to the TV with an HDMI cable.

Caution!

Do not connect the power cable of this Player until all connections are completed.

This Player

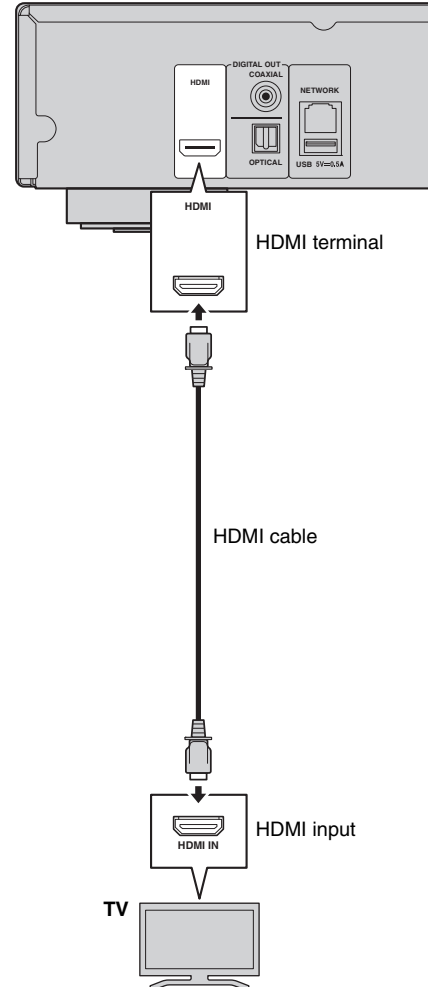

■ Connecting to a TV and audio equipment

Connect this Player to the TV with an HDMI cable, and this Player to the audio equipment with an audio cable (digital optical, digital coaxial or stereo pin cable).

Caution!

Do not connect the power cable of this Player until all connections are completed.

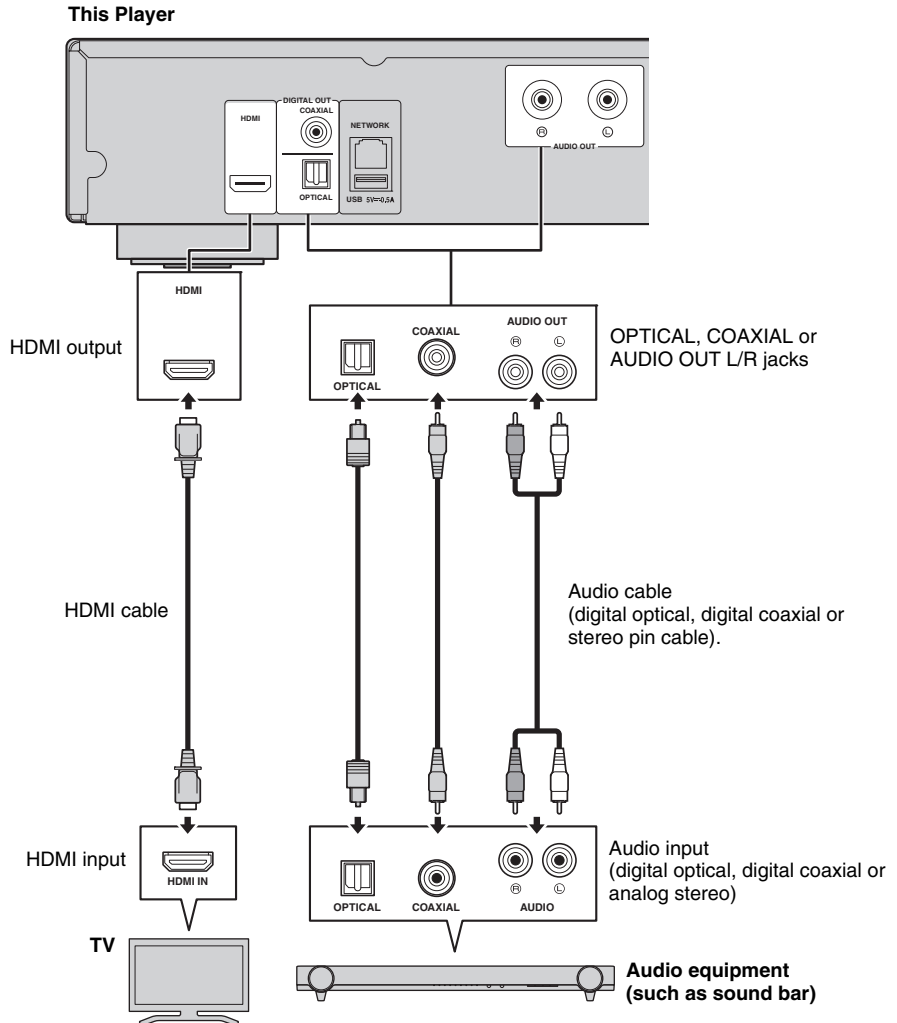

Hints

- To change the output mode of COAXIAL/OPTICAL jacks, configure “Coaxial / Optical” (p. 38) in Audio Setting.
- If the playback audio is output from both the TV speakers and audio equipment, set HDMI in Audio Setting to Off to disable the audio output to the TV.
- Audio signals of SACDs cannot be output from the COAXIAL or OPTICAL jack (p. 41).

Network connection

By connecting this Player to the network (wireless or wired), you can use the following features.

- Playing back DLNA server (PC or NAS) contents (p. 20)
- Playing back various network service contents (p. 22)
- Playing BD-Live compatible discs (p. 29)
- Operating this Player from mobile devices (AV CONTROLLER) (p. 26)

Notes

- To use the network services or BD-Live feature, a broadband internet connection is required.
- Refer to the operation manual of the equipment you have as the connected equipment and connection method may differ depending on your network environment.
- Use a network cable/router supporting 10BASE-T/100BASE-TX.

Hint

- If you are using a router that supports DHCP, you do not need to configure any network settings for this Player, as the network parameters (such as the IP address) will be assigned automatically to it. You only need to configure the network settings if your router does not support DHCP or if you want to configure the network parameters manually (p. 36).

■ Wireless connection

By using the Wi-Fi feature of this Player, you can connect this Player to your network (router) wirelessly. To use the Wi-Fi feature, refer to “Wireless connection setting” (p. 19) and configure the wireless connection setting.

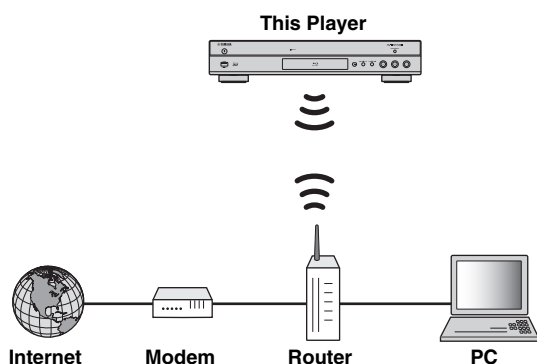

■ Wired connection

Connect this Player to your network (router) with a commercially available Shielded Twisted Pair (STP) network cable.

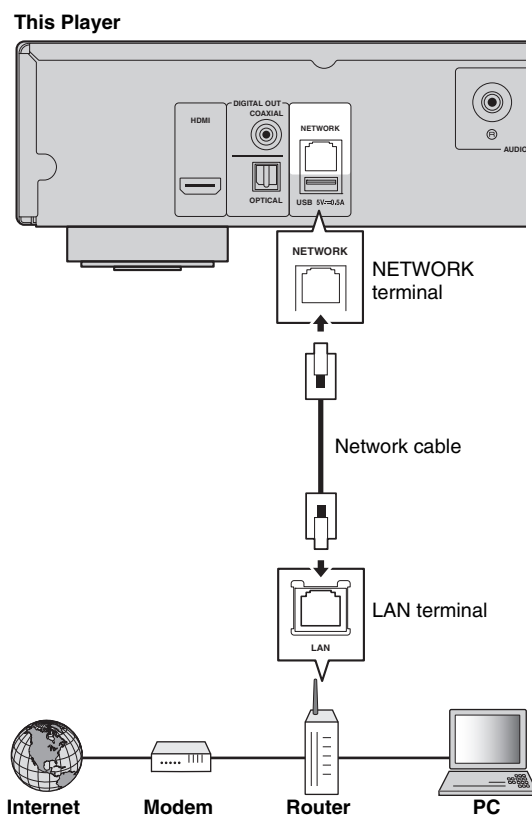

DLNA server setup

By using DLNA, you can share multimedia contents (such as videos, music and photos) stored on your DLNA server (PC or NAS) connected to your network, and enjoy those contents with this Player. In addition, you can use your mobile device (such as a smartphone and a tablet) as a wireless controller to operate this Player through the network.

To use the DLNA features, perform the following DLNA server setup after making the network connection (p. 15).

Notes

- To use DLNA features, all the devices must be connected to the same network.
- To use a NAS as a DLNA server, the NAS must be compatible with DLNA.

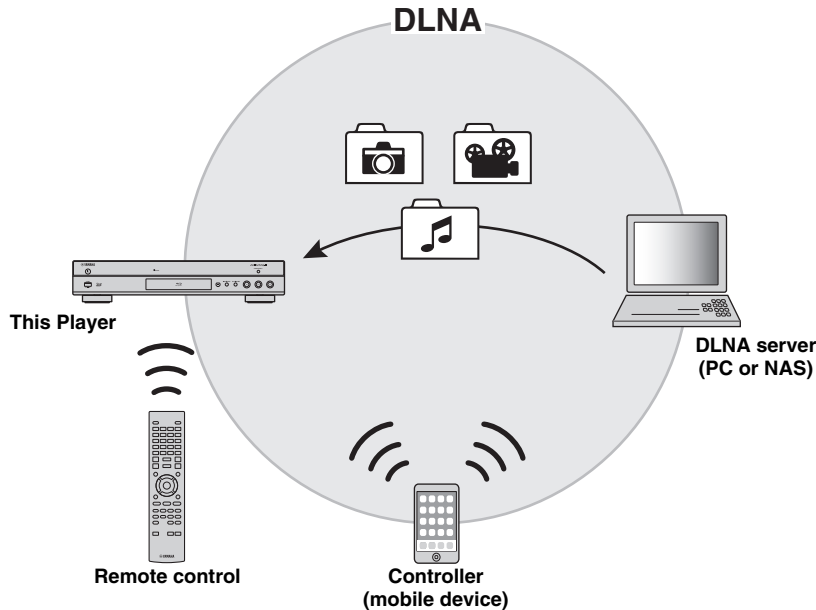

Media sharing setting on DLNA server

To play back multimedia contents stored on your DLNA server (PC or NAS), first you need to configure the media sharing setting on the DLNA server software installed on the DLNA server.

Hint

- For information about DLNA server setting or file formats supported by DLNA server, refer to the owner's manuals of your DLNA server and its software.

- 1 Turn on your DLNA server (PC or NAS) and this Player.
- 2 If you are using a PC as a DLNA server, check that DLNA server software (such as Windows Media Player 12) is installed on your PC.
- 3 On your DLNA server, enable media sharing and allow media to be shared with this Player.
Now the DLNA server setting is complete. To enjoy the DLNA server contents on this Player, select a DLNA server and multimedia file from the HOME menu (p. 20).

Using a mobile device as a media controller

If you have a mobile device (such as smartphone and tablet) that supports the Digital Media Controller (DMC) feature, you can operate this Player from your smart phone or tablet through the network.

Hints

- To allow the mobile device to control this Player, set DMC Control (p. 36) in the SETUP menu to Enable (default).
- To check that your mobile device supports the DMC feature, refer to the owner's manuals of your mobile device and its software.

USB connection

By connecting a USB memory device to the USB connector on the front or the rear panel of this Player, you can play multi-media files stored on the USB memory device (p. 20).

Notes

- Yamaha cannot guarantee that all brands' USB memory devices will operate with this Player.
- Connect a USB memory device to one of the USB connectors (front/rear) of this Player when using BD-Live feature (p. 30).

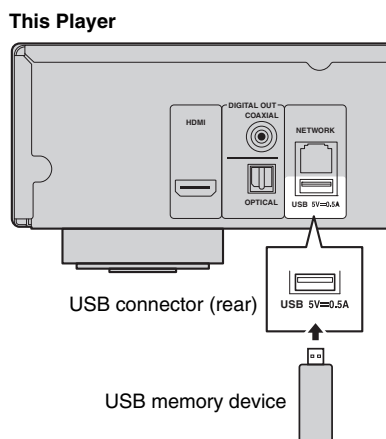
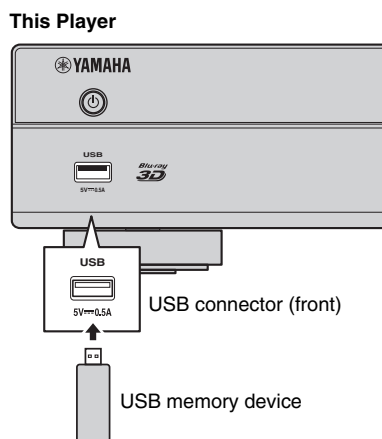

Other connections

■ Connecting to the REMOTE CONTROL jacks

- You can transmit and receive the remote control signals by connecting to the REMOTE CONTROL (OUT/IN) jacks.
- Firmly connect monaural 3.5 mm mini plug cables (commercially available) to the REMOTE CONTROL (OUT/IN) jacks.

Caution!

Do not connect the power cable of this Player until all connections are completed.

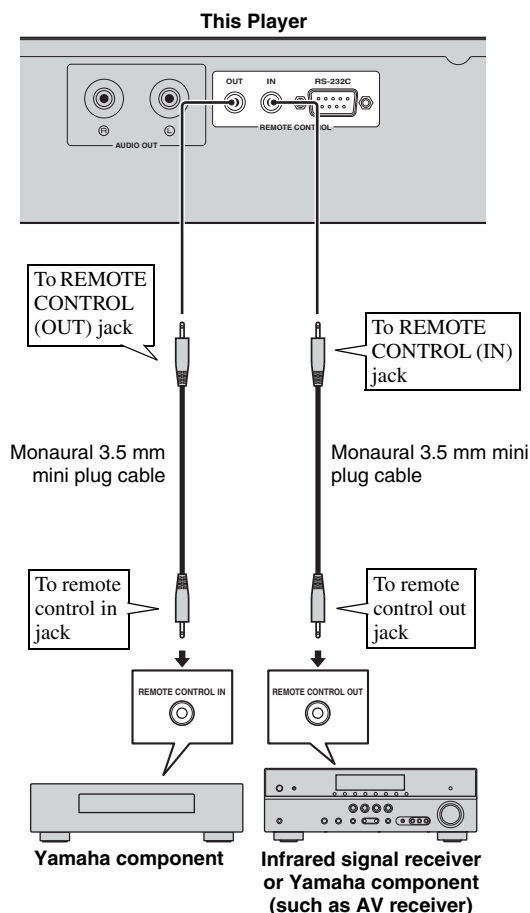

Hints

- If your AV receiver is a Yamaha product and has the capability to transmit SCENE control signals from the REMOTE OUT jack, you can control the Player with the SCENE function. For details about the SCENE function, refer to the owner's manual supplied with your Yamaha AV receiver.
- You can connect a Yamaha component (such as CD player) supports the SCENE function to the REMOTE CONTROL (OUT) jack of this Player.
- The RS-232C terminal is a control expansion terminal for commercial use. Consult your dealer for details.

■ Connecting the power cable

- After all connections are completed, plug the supplied power cable into the AC IN on the rear of the Player. Then plug into AC outlet.

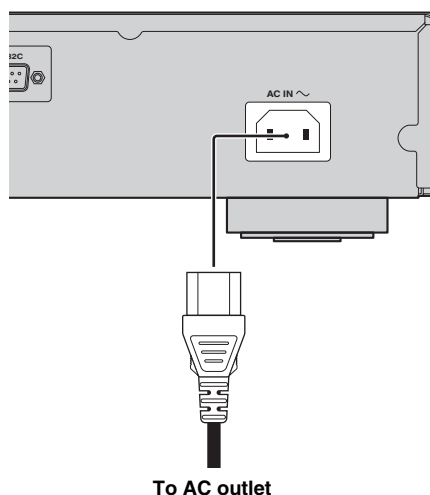

Initial settings

■ Setting with the Easy Setup

Easy Setup allows you to set language, resolution, and screen aspect ratio easily. Easy Setup screen is displayed when you turn this Player on for the first time after purchase. Same setting can be performed from SETUP menu → System → Easy Setup.

- 1 When Easy Setup screen is displayed, press **ENTER** to start Easy Setup.

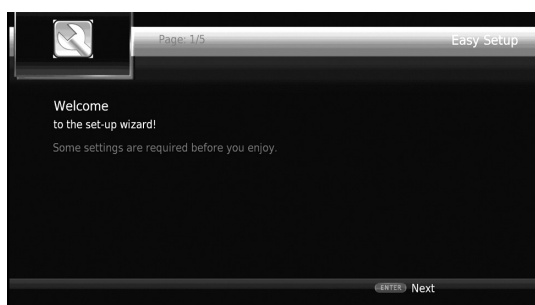

- 2 Set the language, resolution, and screen aspect ratio by following the on-screen messages.

Notes

- When no picture is displayed after Easy Setup is completed, refer to “Troubleshooting” (p. 44).
- A warning message concerning 3D video playback appears when this Player is turned on. Press **ENTER** to dismiss the message or **CLEAR** to disable it (p. 34).

■ Wireless connection setting

To connect this Player to your network (router) wirelessly, follow the procedure below to configure the wireless connection setting.

If your router (access point) supports the WPS (Wi-Fi Protected Setup) function, you can use the auto setup method to connect this Player to the router without entering network information (such as SSID) manually.

- 1 Press **SETUP** to display the SETUP menu screen.
- 2 Select General Setting → Network → Connection setting → Wireless.

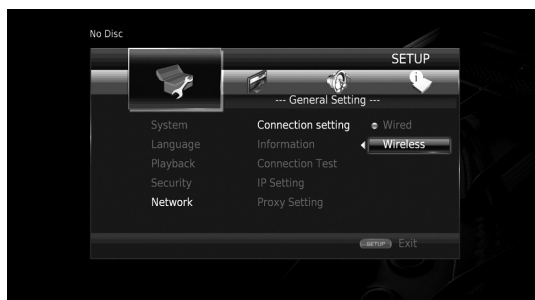

- 3 Press **◀▶** to select Yes, then press **ENTER**.



- 4 Press **◀▶** to select one of the following setup methods, then press **ENTER**.



Scan: Select this option to search for available wireless networks. When the network list is displayed, select the SSID to be connected and enter the password.

Manual: Select this option to enter the network information (such as SSID) manually.

Auto: Select this option to use the WPS function. Select PBC (Push Button Configuration) or PIN code method, then follow the on-screen messages.

Notes

- For details on operations of your router (access point), refer to the owner’s manual of it.
- When the WPS function does not work, select “Scan” or “Manual” to configure the wireless connection settings.
- Devices that use a 2.4 GHz frequency band, such as a microwave, *Bluetooth*, or digital cordless device, may interrupt the wireless communication. Move this Player away from such devices, or turn off such devices.
- The speed of a wireless network connection depends on your network environment (router type, distance between the router and this Player, installation places, etc.). In case the sound or video is interrupted during playback, move this Player closer to the router or change the orientation of this Player or the antenna of the router.

HOME menu

The HOME menu allows you to perform the following basic operations of this Player.

- Browsing and playing multi-media files on various discs, USB memory devices and your DLNA servers (PC or NAS)
- Accessing to various network services (p. 22)
- Displaying the SETUP menu (p. 31)

Hints

- For details on playable discs and formats, see page 3.
- To play DLNA server contents on this Player, the media sharing setting (p. 16) on the DLNA server should be configured.

■ Playing back photo/music/video

Basic operation

◀/▶/▲/▼: Moves the focus.

◀: Returns to the parent folder.

HOME: Moves to/exits HOME menu screen.

ENTER: Confirms the folder/file.

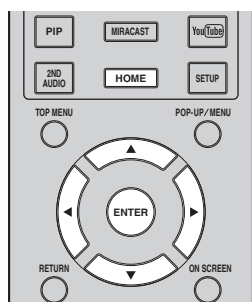

Common operations for playing back files in a selected folder

Example: Selecting a movie file on a USB memory device

Note

- Stop the playback of the video before you move to HOME menu screen.

1 Press **HOME** to move to HOME menu screen.

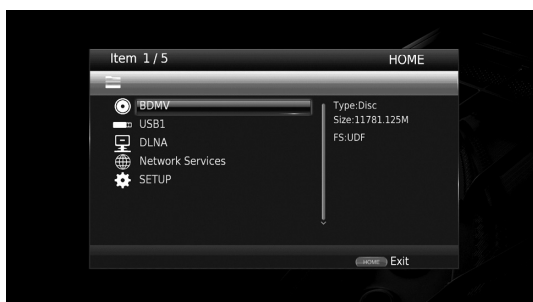

2 Press ▲/▼ to select the item which contains the file you want to play back, then press **ENTER**.

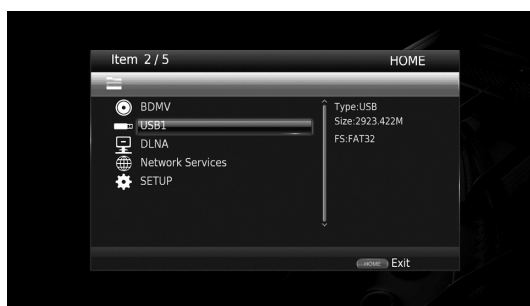

Note

- If your DLNA server is not listed, check that the DLNA server is turned on and select DLNA Search to update the list.

3 Select the Photo, Music, Video or AVCHD folder you want to play back, then press **ENTER**.

To return to the parent folder, press **RETURN** or select .

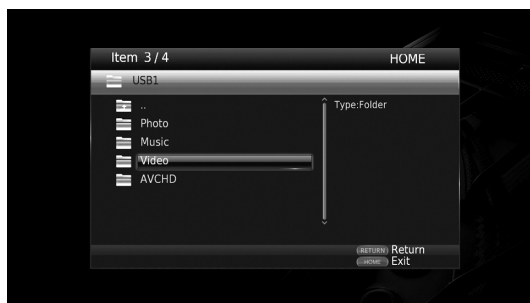

Note

- Note that the only the file type selected on this step will be displayed in the following step. For example, if you selected Photo folder in this step, only photo files are displayed after this step.

- 4 Select the folder containing the file you want to play back.



- 5 Select the file you want to play back, then press **ENTER**.

When a video file is selected, playback starts.

When a music file is selected, status screen is displayed and playback starts.

When a photo file is selected, slide show starts.

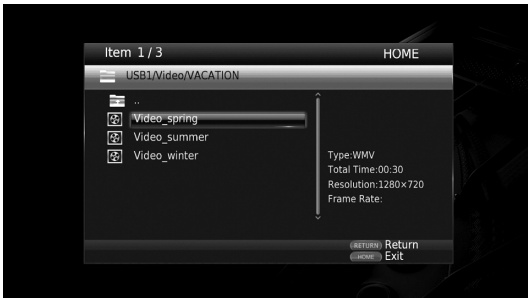
**Hint**

- To enjoy slide show with music, press **HOME** to return to the HOME menu screen while music is played back, and select photo file.

Note

- The displayed file may not be played back depending on the content.

Operations for viewing photos

While viewing photos, the buttons on the remote control work as shown below.

■: Stops slide show and returns to the file browser.

■: Pauses a slide show.

▶: Plays a slide show.

▶▶: Moves to a next photo.

◀◀: Moves to a previous photo.

▶▶▶: Makes a slide show faster in 3 steps.

◀◀◀: Makes a slide show slower in 3 steps.

▲: Inverts a photo.

▼: Reflects a photo.

◀: Rotates a photo counterclockwise.

▶: Rotates a photo clockwise.

ZOOM: Zooms in/out a photo (zoom in/out: 3 steps each).

▲/▼/◀/▶: Pans in zoom mode when a photo is larger than the screen.

Using network services

You can enjoy multimedia contents (such as photos and videos) using the following network services.

- Dropbox
- Picasa Web Albums
- YouTube

Notes

- Access to content provided by third parties requires a high speed internet connection and may also require account registration and a paid subscription.
- Third party content services may be changed, suspended, interrupted, or discontinued at any time without notice, and Yamaha disclaims any liability in connection with such occurrences.
- Some content may only be available for specific countries and may be presented in specific languages.
- Yamaha does not represent or warrant that content services will continue to be provided or available for a particular period of time, and any such warranty, express or implied, is disclaimed.

1 Press **HOME** to move to HOME menu screen.

Hint

- To directly move to the YouTube menu screen, press **YouTube**.

2 Press **▲/▼** to select Network Services, then press **ENTER**.

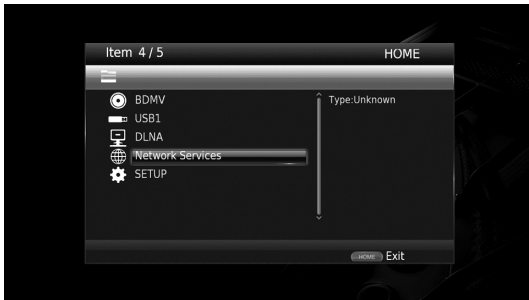

3 Press **◀/▶/▲/▼** to select the desired network service, then press **ENTER**.



4 Press **◀/▶/▲/▼** to select an item, then press **ENTER** to confirm the selection (or start playback).

Hint

- To exit from each network service, press **HOME**.

Note

- Operation procedures after step 4 vary depending on the menu items provided by each service.

■ About Dropbox™

Dropbox is a network service that allows you to put your stuff in Dropbox and get it from your computers, phones, or tablets. Automatically add photos and show off video from anywhere.

More information at www.dropbox.com



Dropbox is a trademark of Dropbox Inc.

■ About Picasa™ Web Albums

Picasa Web Albums is a network service that allows users to share photos with friends and family, or explorer public photos.

More information at picasaweb.google.com



Picasa and the Picasa logo are trademarks of Google. Inc.

■ About YouTube™

YouTube is a network service that allows users to discover, watch and share originally-created videos over the Internet.

More information at www.youtube.com



YouTube and the YouTube logo are trademarks of Google. Inc.

Enjoying music via *Bluetooth*®

You can enjoy music played on a *Bluetooth* device (smartphone, etc.) on this Player.

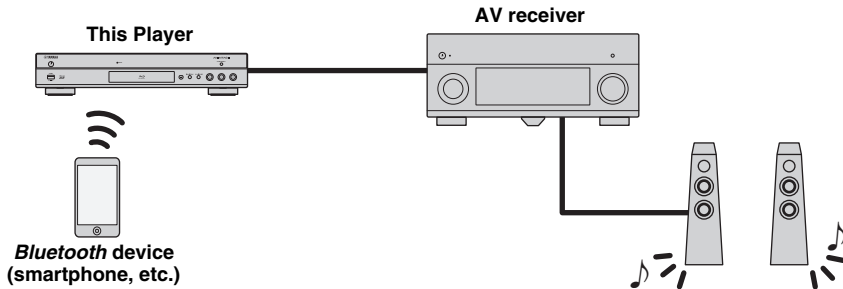

Hints

- “Pairing” is necessary for each *Bluetooth* device you use.
- Use a *Bluetooth* device within 10 meters (33 ft) of this Player.
- See also the owner’s manual of your *Bluetooth* device.

Bluetooth

- *Bluetooth* is a technology for wireless communication between devices within an area of about 10 meters (33 ft) employing the 2.4 GHz frequency band, a band which can be used without a license.

Handling Bluetooth communications

- The 2.4 GHz band used by *Bluetooth* compatible devices is a radio band shared by many types of equipment. While *Bluetooth* compatible devices use a technology minimizing the influence of other components using the same radio band, such influence may reduce the speed or distance of communications and in some cases interrupt communications.
- The speed of signal transfer and the distance at which communications is possible differs according to the distance between the communicating devices, the presence of obstacles, radio wave conditions and type of equipment.
- Yamaha does not guarantee all wireless connections between this unit and devices compatible with *Bluetooth* function.

■ Pairing a Bluetooth device with this Player

When establishing a connecting between a *Bluetooth* device and this Player for the first time, follow the procedure below to perform “pairing”.

Notes

- Up to eight *Bluetooth* devices can be pairing with this Player. If the ninth device is paired, the oldest pairing information is deleted.
- If any *Bluetooth* device is already connected to this Player, terminate the *Bluetooth* connection before performing pairing with a new device.
- When using *Bluetooth*, you cannot operate the disc tray or playback of other sources.

- 1 If playback of other source is ongoing, stop the playback.
- 2 Press **Bluetooth** to select *Bluetooth* as the input source.
- 3 Press **RED** to switch this Player to the pairing mode.
- 4 Turn on your *Bluetooth* device to be paired, then perform the pairing operation.
For details on pairing operation, refer to the owner’s manual of your *Bluetooth* device.
- 5 In the device list on your *Bluetooth* device, select “BD-A1040 Yamaha”.
If pass key (PIN) is required, enter the number “0000”.

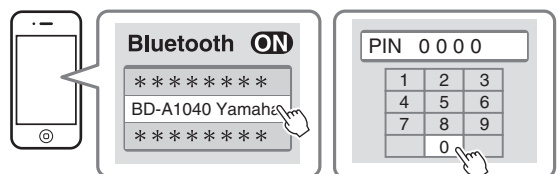

When pairing is completed successfully, “SUCCESS” appears on the front panel display (“Pairing Success” appears on the TV screen).

If pairing failed, “FAILED” appears on the front panel display (“Pairing Failed” appears on the TV screen).

■ Playing back *Bluetooth* device contents

Notes

- If any *Bluetooth* device is already connected to this Player, terminate the *Bluetooth* connection before connecting to another *Bluetooth* device.
 - When using *Bluetooth*, you cannot operate the disc tray or playback of other sources.
- 1 If playback of other source is ongoing, stop the playback.
 - 2 Press **Bluetooth** to select *Bluetooth* as the input source, then turn on your *Bluetooth* device.
A connection between the *Bluetooth* device and this Player will be made.
 - 3 On the *Bluetooth* device, start playback of the desired content.
As necessary, adjust the volume level of the *Bluetooth* device.
 - 4 To terminate the *Bluetooth* connection, press **Bluetooth**.

Hint

- You can also exit from *Bluetooth* by pressing **HOME** or **RETURN**.
- In case a connection between your *Bluetooth* device and this Player cannot be made, select “BD-A1040 Yamaha” in the device list on your *Bluetooth* device.
- The *Bluetooth* connection is automatically terminated if the *Bluetooth* device or this Player is turned off.

Enjoying smartphone pictures and videos on the TV screen (Miracast™)

Miracast is a solution for seamlessly displaying video between devices, without cables or a network connection via an access point (Wi-Fi Direct). You can do things like view pictures from a Miracast-compatible device (smartphone, etc.) on the screen of the TV connected to this Player.

Notes

- To check if your device is Miracast compliant, refer to the owner's manual of the device.
- When Miracast is enabled on this Player, other network functions (such as DLNA) are not available.
- When using Miracast, you cannot operate the disc tray or playback of other sources.

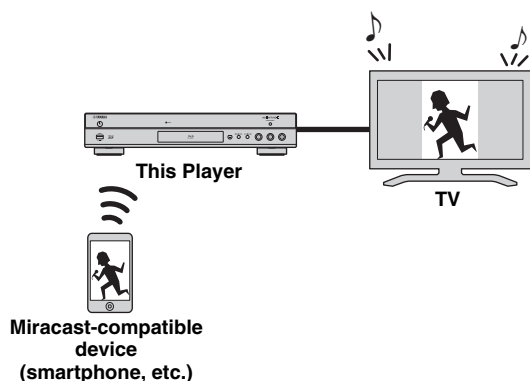

- 1 If playback of other source is ongoing, stop the playback.
- 2 Press **MIRACAST**.
- 3 Within 60 seconds, operate your smartphone to enable Miracast and select this Player as the device to be connected.
For details on operations of your smartphone, refer to the owner's manual of it.
- 4 To exit from Miracast, press **MIRACAST**.

Hint

- You can also exit from Miracast by pressing **HOME** or **RETURN**.

Depending on the environment, audio/video may be interrupted or noise may appear on the TV screen. In this case, try the following solutions.

- Move the Miracast device closer to this Player.
- Turn off other wireless devices not in use.
- Move the Miracast device and this Player away from microwave ovens, *Bluetooth* devices or other wireless devices.

Operating this Player from mobile devices (AV CONTROLLER)

By using the application “AV CONTROLLER” on your mobile device, you can use the mobile device as a remote control and operate this Player from it.



AV CONTROLLER

- You can control the basic functions of Yamaha Blu-ray Disc™ players such as Play, Pause, Skip, Power and cursor navigations.
- The application “AV CONTROLLER” is available in many languages.
- For more information about “AV CONTROLLER”, visit the Yamaha website.

Advanced playback operation

This chapter explains playback of commercially available Blu-ray Discs, DVDs, SA-CDs, CDs, and recorded DVD-RW/R discs.

Note

- For the basic playback operation, see page 8.

■ On Screen menu

To display On Screen menu, press **ON SCREEN**. After that, press **▲/▼/◀/▶** to select an item, then press **ENTER** to operate the desired function.

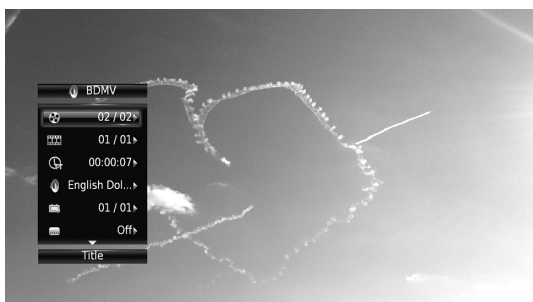

On Screen menu contains following items.

Title **BD** **DVD** **VIDEO** : Shows the title number being played back. You can skip to the desired title by selecting it from this item.

Chapter **BD** **DVD** **VIDEO** : Shows the chapter number being played back. You can skip to the desired chapter by selecting it from this item.

Track/File **CD** **VIDEO** **MUSIC** **PHOTO** : Shows track/file number being played back. You can skip to the desired track/file by selecting it from this item.

Time **BD** **DVD** **CD** **VIDEO** **MUSIC** : Shows the playback time. Select display type from the following:

- Elapsed playback time of the title, chapter, disc, track or file
- Remaining playback time of the title, chapter, disc, track or file

Mode/Play Mode

DVD **CD** **VIDEO** **MUSIC** **PHOTO** : Shows current playback mode. You can select playback mode from the following:

CD

- Normal: Normal playback.
- Shuffle: Random playback without repetition.
- Random: Random playback with repetition.

DVD

- Normal
- Shuffle CH (chapter)
- Shuffle TT (title)
- Shuffle All
- Random CH (chapter)
- Random TT (title)
- Random All

VIDEO MUSIC PHOTO

- Normal
- Shuffle F (folder)
- Random F (folder)

Audio **BD** **DVD** **VIDEO** : Shows audio language/signal of a Blu-ray Disc/DVD currently selected. You can select the desired type of audio.

Angle **BD** **DVD** : Shows the currently-selected angle number. If the video is recorded with multiple angles, you can change the angle.

Subtitle **BD** **DVD** **VIDEO** : Shows the currently-selected subtitle language when the subtitle is provided.

Subtitle Style **BD** : Shows the currently-selected subtitle style. This function is available only for Video-file external subtitle. You can select the desired text style of subtitle.

Bitrate **BD** **DVD** **CD** **VIDEO** **MUSIC** : Shows bitrate of the audio/video signal.

Second Video **BD** : Turns the PIP on/off (p. 8).

Second Audio **BD** : Turns the secondary audio on/off (p. 9).

Ins Search

BD **DVD** **CD** **VIDEO** **MUSIC** : Skips 30 seconds.

Ins Replay

BD **DVD** **CD** **VIDEO** **MUSIC** : Replays the content from 10 seconds before.

CC Select

BD **DVD** **VIDEO** : Sets the displayed closed caption.

Slide Show PHOTO :

Shows slide show speed. You can select the slide show speed from Slow/Medium/Fast.

Transition **PHOTO** : Shows how photo appears on the screen. You can select the transition type.

Code Page **VIDEO** : Selects character code of subtitle you added to DivX video (p. 47).

■ Status menu

This shows various settings, such as subtitles, angle settings and the title/chapter/track number currently played back. To display status menu, press **STATUS**. Status menu contains following menus.

BD DVD VIDEO

Example: Icons when playing a Blu-ray Disc

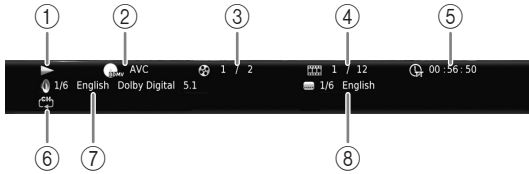

- ① **(Playback status)**
- ② **(Disc type/video file icon)**
- ③ **(Title number being played):** You can jump to specified title with **SEARCH** button (p. 9).
- ④ **(Chapter number being played) **BD DVD**:** You can jump to specified chapter with **SEARCH** button (p. 9).
- ⑤ **(Track/file number being played) **VIDEO**:** You can jump to specified track with **SEARCH** button (p. 9).
- ⑥ **(Elapsed playback time):** You can jump to specified point with **SEARCH** button (p. 9).
- ⑦ **(Repeat mode):** Shows current repeat mode (p. 8).
- ⑧ **(Audio currently selected):** You can change the audio language or format with **AUDIO** button.
- ⑨ **(Subtitle currently selected):** You can change the subtitle language with **SUBTITLE** button.

DVD CD MUSIC

Example: Icons when playing a music file

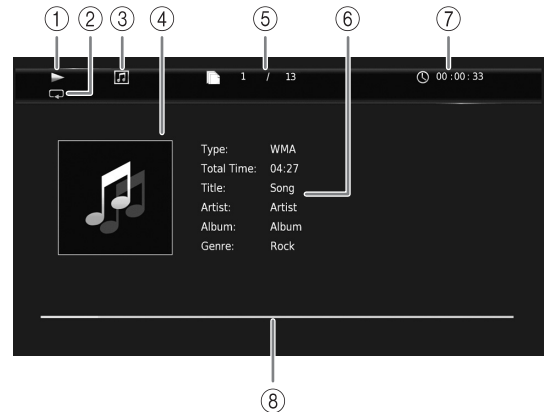

- ① **(Playback status)**
- ② **(Repeat mode):** Shows current repeat mode (p. 8).
- ③ **(Disc type/music file icon)**
- ④ **(Artwork) **MUSIC**:** Displays artwork if the file contains it.
- ⑤ **(Track/file number being played):** You can jump to specified track with **SEARCH** button (p. 9).
- ⑥ **(Information) **MUSIC**:** Displays music information if the file contains them.
- ⑦ **(Elapsed playback time):** You can jump to specified point with **SEARCH** button (p. 9).
- ⑧ **(Progress bar) **MUSIC**:** Shows progress status of current song.

PHOTO

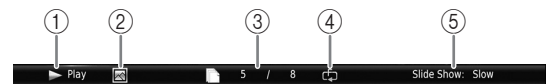

- ① **(Playback status)**
- ② **(Photo file icon)**
- ③ **(File number being displayed)**
- ④ **(Repeat mode):** Shows current repeat mode (p. 8).
- ⑤ **(Slide show speed)**

■ Program play **DVD** **CD**

This allows you to program playback order of audio disc tracks or DVD chapters.

Press **PROGRAM** during playback to display the **PROGRAM** window to program playback order. You can program up to 15 tracks/chapters.

Example: Programming the playback order of CD tracks

- 1 Press **PROGRAM** during playback.



- 2 Press **ENTER** to program playback order. For audio disc, press **▲/▼** to select a desired track then press **ENTER**. For DVD-Video disc, select a desired title (shown as **TT**) and chapter (shown as **CH**) instead of a track. To clear a set track, select the track you want to clear, then press **CLEAR**. Press **RETURN** to cancel the Program play.



- 3 After programming is finished, press **▶** to set and start program playback.
- 4 To cancel program play, stop playback completely by pressing **■**.





■ Using Search

BD **DVD** **CD** **VIDEO** **MUSIC** **PHOTO**



This allows you to jump to the specified point during playback.

- 1 Press **SEARCH** during playback. Status bar appears.
- 2 Press **▲/▼/◀/▶** to select one of the item below, then press **ENTER**.

BD **DVD** :

- Title number (shown as )
- Chapter number (shown as )
- Elapsed title time (shown as )
- Elapsed chapter time (shown as )

CD :

- Track number (shown as )
- Elapsed track time (shown as )
- Elapsed disc time (shown as )

VIDEO **MUSIC** :





- File number (shown as )
- Chapter number (shown as )
- Elapsed file time (shown as )

PHOTO :

- File number (shown as )

- 3 Press **▲/▼** or number buttons to set/adjust the value of the focused item, and press **ENTER** to jump to the specified point.
- 4 To close the status bar, press **STATUS**.

■ Enjoying BONUSVIEW™ and BD-Live™

This Player supports BONUSVIEW (p. 47) (BD-ROM Profile 1 Version 1.1) and BD-Live (p. 47) (BD-ROM Profile 2) playback functions.



Note

- Functions and playback method vary depending on the disc. See the guidance on the disc or the supplied user's manual.

■ Using Picture in Picture function (secondary audio/video playback)

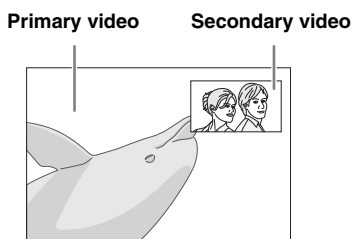
BD-Video that includes secondary audio and video compatible with Picture in Picture can be played back with secondary audio and video simultaneously as a small video in the corner.



While PIP Mark () or Secondary Audio Mark () is displayed, press PIP to turn the Picture in Picture function on/off.

Notes

- To listen to secondary audio, make sure that the Audio Output setting (Coaxial / Optical or HDMI) is set to PCM or Reencode (p. 38).
- Depending on the disc, to listen to secondary audio, you may need to set secondary audio to on from the top menu of the disc (p. 9).
- The secondary audio and video for Picture in Picture may automatically play back and be removed depending on the content. Also, playable areas may be restricted.

■ Using the feature of BD-Live™

1. Set the Network setting (p. 36).

2. Connect the USB memory device to this Player (p. 17).

BD-Live data is saved in a USB memory device connected to this Player. To enjoy these functions, connect a USB memory device supporting USB 2.0 High Speed (480 Mbit/s) to one of the USB connectors (front/rear) of this Player to use the USB memory device as Local Storage.

- Local Storage is used as an auxiliary memory when Blu-ray Disc is played back.
- Use a USB memory device with at least 2GB of free space.
- BUDA folder is created automatically in the USB memory device when necessary.
- If there is insufficient storage space, the data will not be copied/downloaded. Delete unneeded data or use a new USB memory device.
- Some time may be required for the data to load (read/write).

Notes

- Yamaha cannot guarantee that all brands' USB memory devices will operate with this Player.
- Do not use a USB extension cable when connecting a USB memory device to the USB connector of the Player. Using a USB extension cable may prevent the Player from performing correctly.

3. Play back the disc.

4. Run BD-Live according to the instructions on the disc.



Notes

- Do not remove the USB memory device or disconnect unplug the power cable during BD-Live operations.
- Regarding playback method of BD-Live contents, etc., perform the operations in accordance with the instructions in the Blu-ray Disc manual.
- To enjoy BD-Live functions, perform the network connection (p. 15) and Network settings (p. 36).
- Refer to "BD-Live Connection" (p. 36) regarding the setup to restrict access to BD-Live contents.
- The time required to download the provided programs into the USB memory device connected to this Player varies depending on the internet connection speeds and the data volume of the programs.
- BD-Live programs provided through the internet may not be able to display the connection depending on the status (upgrading) of the provider. In such cases, take out the disc and try again.
- If the BD-Live screen does not appear for a while after you select the BD-Live function in the Blu-ray Disc menu, the USB memory device may not have enough free space. In such cases, eject the disc from the Player, and then erase the data in the USB memory device using the "Format" menu in the "Local Storage" (p. 34).

SETUP menu

The SETUP menu enables various audio/visual settings and adjustments for functions using the remote control unit.

Menu/Submenu	Item	Function	Page	
 General Setting	System			
	Auto Power Standby	Sets the power-saving function to on/off.	34	
	HDMI Control	Sets this Player to receive control signal from the remote control of your TV/AV receiver.	34	
	Load Default	Resets all settings to the default setting except Security setting.	34	
	Upgrade	Performs upgrade of this Player.	34	
	Upgrade Notification	Selects whether to display the message on the screen when this Player detects newer software over the Internet.	34	
	3D Playback Message	Displays a warning message concerning 3D video playback when this Player is turned on.	34	
	Local Storage	Displays the free space of USB memory device connected to this Player, or formats the "BUDA" folder in the USB memory device.	34	
	Easy Setup	Sets language, resolution, screen aspect ratio.	34	
	Language			
	OSD	Selects the language for On Screen Display.	34	
	Menu	Prioritizes the language for disc menu.	34	
	Audio	Prioritizes the language for audio.	34	
	Subtitle	Prioritizes the language for subtitle.	35	
	Playback			
	Disc Auto Playback	Sets this Player to start disc playback automatically.	35	
	Angle Mark	Sets to display the Angle Mark when Blu-ray Disc/DVD with multiple angles is played back.	35	
	PIP Mark	Sets to display the PIP Mark when Blu-ray Disc/DVD with Picture in Picture is played back.	35	
	Secondary Audio Mark	Sets to display the Secondary Audio Mark when Blu-ray Disc/DVD with secondary audio is played back.	35	
	Last Memory	Sets this Player to remember the last playback position of a disc (Blu-ray or DVD video) when it is set to standby mode or the disc tray is opened.	35	
	DivX(R) VOD DRM	Displays registration code for DivX(R) video.	35	
	DivX Subtitle	Selects whether to display a subtitle for DivX(R) video.	35	
	DVD-Audio Mode	Selects the playback mode for DVD-Audio discs.	35	
	Security			
	Change Password	Changes password for Parental Control and Country Code.	35	
	Parental Control	Sets the Parental Control depending on the disc content.	35	
	Country Code	Sets your Country Code.	35	
	Network			
	Connection setting	Sets a network connection method.	36	
	Information	Displays network information screen.	36	
	Connection Test	Performs the network connection test.	36	
	IP Setting	Sets the IP setting to Auto/Manual.	36	
	Proxy Setting	Sets the proxy setting.	36	
	Network Control	Sets the control for devices, which are connected via Ethernet, to On/Off.	36	
	Network Standby	Selects whether this Player can be turned on from other network devices.	36	
	DMC Control	Selects whether to allow DLNA-compatible Digital Media Controller (DMC) (p. 16) to control this Player.	36	
	BD-Live Connection	Sets the BD-Live connection to Permitted/Partial Permitted/Prohibited.	36	

Menu/Submenu	Item	Function	Page		
 Display Setting	TV	3D Output	Selects 3D or 2D videos.	37	
		TV Screen	Sets the screen aspect ratio of the connected TV, and adjust the video output.	37	
		HDMI Resolution	Selects the HDMI video output resolution.	37	
		TV System	Selects the TV System from NTSC/PAL/Multi.	37	
		Color Space	Selects Color Space from YCbCr 4:4:4/YCbCr 4:2:2/Full RGB/RGB.	37	
		HDMI Deep Color	Selects HDMI Deep Color from 30 bits/36 bits/48 bits/Off.	37	
		HDMI 1080p 24Hz	Sets HDMI 1080p 24Hz to auto/off.	38	
	Video Process	Noise Reduction	Sets the level of Noise Reduction.	38	
		De-interlacing Mode	Sets how to detect the video signal.	38	
	Closed Caption	CC Attribute	Sets the appearance of closed captions.	38	
		Font color Font size Font style Font opacity Font edge Font edge color BG color BG opacity Window color Window opacity	Customize the font, background and window used for closed captions when CC Attribute is set to Custom.	38	
		Audio Output	Coaxial / Optical	Selects the output mode of COAXIAL jack/OPTICAL terminal from Bitstream/PCM/Reencode/Off.	38
			HDMI	Selects the output mode of HDMI terminal from Bitstream/PCM/Reencode/Off.	38
Downsampling			Selects the digital audio signal down sampling frequency from 48K/96K/192K.	38	
DRC			Sets the DRC (Dynamic Range Compression).	38	
SACD Output		Output Priority	Selects output priority for playing back SA-CDs from HDMI or Analog.	39	
		SACD Priority	Selects the playing back priority for 2-channel contents or multi-channel contents, when the disc contains both types of contents.	39	
		HDMI Output	Selects the output mode of HDMI terminal from DSD or PCM when SA-CD is played back.	39	
Speaker Setting		2ch Downmix	Sets the audio output from AUDIO OUT L/R jack.	39	
Post Process	UpMix	Multi-channelizes the 2-channel audio signal.	39		
 System Information		Displays software version and MAC address (p. 48).	39		

■ Example of SETUP menu operation

You need to call up the SETUP menu screen to perform settings for this Player. The following is the explanation for basic operations of the SETUP menu.

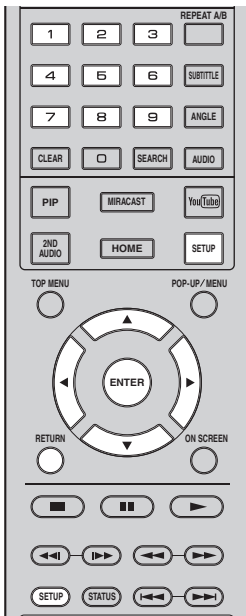



Example: Setting Disc Auto Playback



Note

- Some items cannot be set during playback. In this case, press  to stop playback completely before setting.



1. Display the SETUP menu screen.

Press **SETUP** to display the SETUP menu screen. Press   to select General Setting, then press **ENTER** or .

2. Select a Submenu.



Press   to select Playback, then press **ENTER** or cursor .

3. Select a menu item.

Press   to select Disc Auto Playback, then press **ENTER** or cursor .



4. Select a desired setting.

Press   to select On or Off, then press **ENTER**.



Hint

- You need to use the number buttons to enter numbers (such as password) for some menu items.

5. Exit the menu screen.

Press  to return to the previous menu.

■ General Setting



The default settings are marked with “*”.

System

Auto Power Standby

Sets the power-saving function to on/off.

When set to on, this Player will switch to screen saver mode if there is no operation for 5 minutes. After that, this Player will turn to standby mode when there is no operation for 15 minutes.

On*, Off

HDMI Control

You can set the Player to receive control signal from a TV/AV receiver compatible with the HDMI Control function via an HDMI cable (p. 12).

On, Off*

Using HDMI Control function

Using the HDMI Control function, you can interactively operate this Player with your TV (HDMI Control function supported).

When you connect this Player to the TV compatible with the HDMI Control function using an HDMI cable and set HDMI Control in the SETUP menu to on (p. 34), you can perform the function listed below.

- Automatic input select function
When you start playback of this Player, the input selector of the TV (and an AV receiver if this Player is connected to the TV via the AV receiver) is switched to this Player automatically. TV Power is turned on automatically depending on the TV.
- Automatic power off function
When you turn off the TV while this Player is in stop mode and the SETUP menu screen is not displayed, the power of this Player is also turned off automatically.

Notes

- HDMI Control function may not work properly depending on the TV.
- Functions other than ones shown above may work depending on the TV or AV receiver.
- In order to make the HDMI Control function available, set up settings for the HDMI Control function on ALL components (this Player, TV, and AV receiver). Certain operation may also be required.
- Each function may be set independently to activate/deactivate depending on the TV.
- Refer to the operation manuals supplied with the TV and/or AV receiver for details regarding setup.
- When set to on, power consumption during standby mode increases due to HDMI Control function.

Load Default

You can reset all settings of this Player to default setting except Security setting (p. 35). For details on default settings, see pages 31–39.

Upgrade

You can upgrade the software manually from USB Storage or Network. For details on software upgrade, refer to “Software upgrade” (p. 42).

Upgrade Notification

You can select whether to display the message on the screen when this Player detects newer software over the Internet.

On*, Off

3D Playback Message

You can turn on or off a warning message concerning 3D video playback that appears on the TV when this Player is turned on.

On*, Off

Local Storage

You can check the free space of USB memory device connected to this Player, or format (empty) the “BUDA” folder in the USB memory device connected to this Player by selecting Format.

Hint

- To enjoy the BD-Live feature (p. 30), you need to connect a USB memory device (with at least 2GB of free space) to one of the USB connectors (front/rear) of this Player to use the USB memory device as Local Storage.

Easy Setup

You can perform Easy Setup (p. 19).

Language

OSD

You can select the language for On Screen Display which is the messages or menu displayed on the screen such as SETUP menu.

English, Français, Español, Deutsch, Italiano, Svenska, Nederlandse, Polski, Русский, 中文

Menu

You can prioritize the language for disc menu.

English, Français, 中文, Español, Deutsch, Italiano, Nederlandse, Portuguese, Danish, Svenska, Finnish, Norwegian, Polski, Русский, Korean, Japanese, More

Audio

You can prioritize the audio language for Blu-ray Disc/DVD playback. For details on setting items, see “Menu” (p. 34).

Subtitle

You can prioritize the language for Subtitle.

English, Français, 中文, Español, Deutsch, Italiano, Nederlandse, Portuguese, Danish, Svenska, Finnish, Norwegian, Polski, Русский, Korean, Japanese, More, Off

(The default settings in [Language] differ depending on your model.)

Playback

Disc Auto Playback

You can set Disc Auto Playback to on/off. When set to on, a disc will play back automatically after loading.

On*, Off

Angle Mark

You can set to display the Angle Mark () when Blu-ray Disc/DVD with multiple angles is played back.

On*, Off

PIP Mark

You can set to display the PIP Mark () when Blu-ray Disc with picture in picture (p. 30) is played back.

On*, Off

Secondary Audio Mark

You can set to display the Secondary Audio Mark () when Blu-ray Disc with secondary audio is played back.

On*, Off

Last Memory

You can set whether this Player remembers the last playback position of a disc (Blu-ray or DVD video) when it is set to standby mode or the disc tray is opened.

On*, Off

Note

- Some discs are not compatible with this function.

DivX(R) VOD DRM

You can display registration code for DivX(R) video.

DivX Subtitle

You can select whether to display a subtitle for DivX(R) video.

On, Off*

DVD-Audio Mode

You can select the playback mode for DVD-Audio discs.

DVD-AUDIO* Enables playback of DVD-Audio contents as well as DVD-Video contents.

DVD-VIDEO Disables playback of DVD-Audio contents so that only DVD-Video contents can be played back.

Notes

- This setting is only available when no disc is loaded.
- Some DVD-Audio titles contain DVD-Video contents which can be accessible only when this Player is in the DVD-Video mode.

Security

Change Password

You can set the password for changing the Parental Control Level and Country Code. Refer to “Parental Control” (p. 35) and “Country Code” (p. 35).

Notes

- The default password is 0000.
- If you forget the password, refer to “Troubleshooting” (p. 43) and set all the Security settings to their default settings.

Parental Control

In some Blu-ray Discs/DVDs, a control level for disc viewing is set depending on the age of the viewer. You can set the Parental Control shown on the screen depending on the disc content.

The password (see “Change Password” on p. 35) needs to be entered before the Parental Control Levels is set. After you set the Parental Control, when you play back a disc with level higher than current Parental Control Level, or you want to change the Parental Control Level, a dialog box will pop up to ask you to enter the password.

Off*, 1–8

Country Code

You can set the Country Code you live in. The password (see “Change Password” on p. 35) needs to be entered before the Country Code is set. This setting may be used for rating of Parental Control and disc playback.

Network

Connection setting

You can select a network connection method.

- Wired*** Connects the network using Ethernet.
- Wireless** Connects the network using a wireless LAN. You can select settings for a wireless LAN connection. Follow the on-screen instructions to proceed.

Scan

Searches for an access point. You can connect the access point that is found.

Manual

You can manually set information for an access point.

Auto

If your access point supports the WPS (Wi-Fi Protected Setup) function, you can use the auto setup method to connect this Player to the access point without entering information manually. Select PBC (Push Button Configuration) or PIN code method.

Information

You can display network information screen. On this screen, you can view the information of Interface (Ethernet), Address Type, IP Address, Subnet Mask, Default Gateway, and DNS.

Connection Test

You can perform an internet connection test. If the test is failed, please check "IP Setting" (p. 36) and perform the test again.

IP Setting

You can configure the network settings.

- Auto*** Select to automatically configure the network settings of this Player with the DHCP server.
- Manual** Select to configure the network settings (IP Address, Subnet Mask, Default Gateway, and DNS) manually.

Hints

- **Numeric keys** Enters characters.
- **◀▶** Moves the highlight.
- **CLEAR** Deletes a character.
- **ENTER** Saves the settings and exits from the menu.

Proxy Setting

You can set Proxy Setting. Set to Disable for normal use. Set to Enable to set the proxy setting.

- Disable*** Sets proxy server to disable. Select this item when proxy server is not used.
- Enable** Enables proxy host and proxy port setting.
- Proxy Host** Sets proxy host.
- Proxy Port** Sets proxy port.

Network Control

Sets the control for devices, which are connected via Ethernet, to On/Off. When On with filter is selected, you can specify the MAC addresses of the network devices that will be permitted access to this Player. This Player employs Yamaha Network Control protocol (YNC).

On*, On with filter, Off

Notes

- When Network Control is enable, power consumption during standby mode increases due to network control function.
- When set to On, the system startup time is decreased.

Network Standby

You can select whether this Player can be turned on from other network devices such as "AV CONTROLLER" (p. 26).

On, Off*

Note

- This setting is available only when Network Control is enabled.

DMC Control

You can select whether to allow DLNA-compatible Digital Media Controller (DMC) (p. 16) to control this Player.

Enable*, Disable

BD-Live Connection

You can set access restriction to BD-Live contents.

- Permitted** Allows all BD-Live discs to connect the network.
- Partial Permitted*** Allows only discs with owner certification.
- Prohibited** Prohibits all BD-Live discs to connect the network.

■ Display Setting



The default settings are marked with “*”.

TV

3D Output

You can select 3D or 2D video output from this Player.

- Auto*** This Player automatically selects 3D or 2D videos.
- Off** This Player always selects 2D videos.

Note

- Even if you set “3D Output” to “Auto” and play back a Blu-ray 3D Disc, this Player selects 2D images depending on the setting of TV, etc.



TV Screen

You can set the screen aspect ratio of the connected TV, and adjust the video output.

If you switch your TV (i.e. because you have bought a new one) and the screen aspect ratio of the connected TV changes, you will have to change the TV Screen setting.

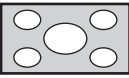
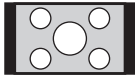
- 16:9 Full** Select this when this Player is connected to a TV with a 16:9 screen. When a 4:3 aspect ratio video is played back, the video is displayed as shown below.
- 16:9 Normal*** Select this when this Player is connected to a TV with a 16:9 screen. When a 4:3 aspect ratio video is played back, the video is displayed as shown below.
- 4:3 Pan Scan** Select this when this Player is connected to a TV with a 4:3 screen. When a 16:9 aspect ratio video is played back, the video is displayed as shown below.
- 4:3 Letter Box** Select this when this Player is connected to a TV with a 4:3 screen. When a 16:9 aspect ratio video is played back, the video is displayed as shown below.

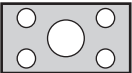
Original image size	On 16:9 (wide screen) TV	
	16:9 Full	16:9 Normal
 4:3		

Original image size	On 4:3 TV	
	4:3 Pan Scan	4:3 Letter Box
 16:9		

HDMI Resolution

You can select the HDMI video output resolution. For more details on output formats, refer to “About the HDMI video output formats” (p. 41).

When set to Auto, resolution is set to the maximum resolution according to the connected TV.

When set to Disc Native, the original resolution and video frequency, recorded in the Blu-ray Disc or DVD that is played back, are used. You can use a video up-converter function of an external device.

When other than a Blu-ray Disc or DVD is played back, the resolution and video frequency will work as Auto. If a Blu-ray Disc or DVD whose resolution and video frequency are not compatible with the connected TV, no image will be output. In this case, stop playback, and select an option other than Disc Native.

Auto*, Disc Native, 480i/576i, 480p/576p, 720p, 1080i, 1080p

Note

- To output HD audio (Dolby TrueHD or DTS-HD Master Audio) from HDMI terminal, set HDMI Resolution to Auto or more than 720p.

TV System

You can select TV System from PAL, NTSC and Multi. Set the same TV System as your TV set. For more details on output formats, refer to “About the HDMI video output formats” (p. 41).

NTSC, PAL, Multi

(The default setting differs depending on your model.)

Color Space

You can select the Color Space (p. 47) output from HDMI. This function is available when this Player is connected with an HDMI cable.

YCbCr 4:4:4* Sets Color Space to YCbCr 4:4:4.

YCbCr 4:2:2 Sets Color Space to YCbCr 4:2:2.

Full RGB When RGB is set and white and black on the screen are too faint, select this item. This setting is effective when a connected component supports RGB 0–255 range.

RGB Outputs video signal at normal signal range.

Note

- This function is only available on TVs that support this function.

HDMI Deep Color

When your TV and/or AV receiver is compatible with Deep Color (p. 47), set this item according to your TV/AV receiver. This function is available when this Player is connected with an HDMI cable.

30 bits, 36 bits, 48 bits, Off*

HDMI 1080p 24Hz

This outputs the BD-Video encoded in 24Hz frame rate in HDMI 1080p 24Hz. Smoother video playback may be available with this function. This function is available when your TV/AV receiver support this function. For more details on output formats, refer to “About the HDMI video output formats” (p. 41).

Auto*, Off

Note

- This setting is disabled when output resolution is other than 1080p.

Video Process

Noise Reduction

You can set the Noise Reduction to a level of 0 to 3. 0 is off, and 3 is the maximum level.

0, 1, 2*, 3

De-interlacing Mode

You can select how to detect the video signal. Set to Auto for normal use. When horizontal stripping noise appears on the screen, set this to Film/Video to remove the noise.

Auto*, Film, Video

Closed Caption

CC Attribute

You can set the appearance of closed captions. When Auto is selected, digital closed captions will be displayed in default settings. When Custom is selected, you can customize the appearance of closed captions (Font color, Font size, etc.) manually.

Auto, Custom

Font color, Font size, Font style, Font opacity, Font edge, Font edge color, BG color, BG opacity, Window color, Window opacity

Customize the font, background and window used for closed captions when CC Attribute is set to Custom.

Audio Setting



The default settings are marked with “*”.

Audio Output

Coaxial / Optical

You can select the output mode of COAXIAL jack and OPTICAL terminal. For more details on output formats, refer to “About the audio output formats” (p. 40).

Bitstream Outputs digital signal without any processing. Secondary Audio is not output.

PCM Outputs 2-channel PCM.

Reencode* Outputs Bitstream with Secondary Audio.

Off Mutes sound.

HDMI

You can select the output mode of HDMI terminal. For details on setting items, see “Coaxial / Optical” (p. 38). For more details on output formats, refer to “About the audio output formats” (p. 40).

Bitstream*, PCM, Reencode, Off

Note

- To output HD audio (Dolby TrueHD or DTS-HD Master Audio) from HDMI terminal, set HDMI Resolution to Auto or more than 720p (p. 37).

Downsampling

You can select digital audio signal down-sample frequency. This function is effective for the audio signal output from the COAXIAL jack/OPTICAL terminal.

48K* The highest sampling rate of digital PCM output is 48 kHz.

96K The highest sampling rate of digital PCM output is 96 kHz.

192K The highest sampling rate of digital PCM output is 192 kHz.

DRC

You can set the DRC (Dynamic Range Compression) (p. 47) to on/off/Auto. When set to Auto, DRC is automatically turned on for a source with DRC information in Dolby TrueHD format. DRC makes the strong sound such as plusive sound lower, and conversations more audible. It is useful when you watch movies in the night.

Off, On, Auto*

SACD Output

Output Priority

You can select the output priority from HDMI or Analog for playing back SA-CDs.

- HDMI*** The settings for SACD Priority and HDMI Output are applied.
- Analog** Always plays back the SA-CD's high quality 2-channel area. The signal is fully optimized for analog 2-channel outputs to be best quality.

Note

- Selecting Analog mutes the HDMI output when SA-CD is played back. For details, see "SA-CD output formats" (p. 41).

SACD Priority

Selects the playing back priority for 2-channel contents or multi-channel contents, when the disc contains both types of contents.

Multi-ch*, 2-ch

HDMI Output

You can select audio signal output from HDMI terminal when SA-CD is played back.

- DSD*** Outputs DSD raw signal. When this Player is connected to DSD compatible AV receiver, this item is recommended.
- PCM** Outputs PCM signal decoded by this Player.

Speaker Setting

2ch Downmix

You can select down mix method to analog 2-ch from Stereo or Lt/Rt.

- Stereo*** Changes channel output to stereo, which only delivers sound from the two front speakers.
- Lt/Rt** Select this item if this unit is connected to a Dolby Pro Logic decoder. Sound from rear speakers is mixed to the 2-ch stereo sound.

Post Process

UpMix

You can multi-channelize the 2-channel audio signal. To multi-channelize, select DTS NEO:6, then select Cinema or Music mode.

Off*, DTS NEO:6

System Information



Software version and MAC address (p. 48) are displayed.

About the audio output formats

Source format		HDMI			COAXIAL / OPTICAL			MIXED 2CH
		Bitstream	PCM	Reencode	Bitstream	PCM	Reencode	–
PCM 2ch	with SA or BCS*1	PCM 2ch		Dolby Digital	PCM 2ch		Dolby Digital	2ch
	without SA or BCS*1	PCM 2ch			PCM 2ch			2ch
PCM 5.1ch	with SA or BCS*1	PCM 5.1ch		Dolby Digital	PCM 2ch		Dolby Digital	2ch
	without SA or BCS*1	PCM 5.1ch			PCM 2ch			2ch
PCM 7.1ch	with SA or BCS*1	PCM 7.1ch		Dolby Digital	PCM 2ch		Dolby Digital	2ch
	without SA or BCS*1	PCM 7.1ch			PCM 2ch			2ch
Dolby Digital	with SA or BCS*1	Dolby Digital	PCM up to 5.1ch	Dolby Digital	Dolby Digital	PCM 2ch	Dolby Digital	2ch
	without SA or BCS*1							
Dolby Digital Plus	with SA or BCS*1	Dolby Digital Plus	PCM up to 7.1ch	Dolby Digital	Dolby Digital	PCM 2ch	Dolby Digital	2ch
	without SA or BCS*1							
Dolby TrueHD	with SA or BCS*1	Dolby TrueHD	PCM up to 7.1ch	Dolby Digital	Dolby Digital	PCM 2ch	Dolby Digital	2ch
	without SA or BCS*1							
DTS	with SA or BCS*1	DTS	PCM up to 5.1ch*2	DTS*3	DTS	PCM 2ch*2	DTS*3	2ch*2
	without SA or BCS*1							
DTS HD High Resolution	with SA or BCS*1	DTS-HD High Resolution	PCM up to 7.1ch*2	DTS*3	DTS	PCM 2ch*2	DTS*3	2ch*2
	without SA or BCS*1							
DTS-HD Master Audio	with SA or BCS*1	DTS-HD Master Audio	PCM up to 7.1ch*2	DTS*3	DTS	PCM 2ch*2	DTS*3	2ch*2
	without SA or BCS*1							

*1 “SA” is a Secondary Audio. “BCS” is a button click sound, the sound effect for pop-up menus, etc.

*2 For USB, DLNA and network services, PCM and mixed 2ch are not available (muted).

*3 For USB, DLNA and network services, Reencode is not available (output audio will be same format as bitstream).

Notes

- When Coaxial / Optical or HDMI is set to Bitstream, secondary audio is not output. (p. 38)
- To output HD audio (Dolby TrueHD or DTS-HD Master Audio) from HDMI terminal, set HDMI Resolution to Auto or more than 720p (p. 37).

SA-CD output formats

SACD Output settings (p. 39)			HDMI	COAXIAL/OPTICAL	MIXED 2CH
Output Priority	SACD Priority	HDMI Output			
HDMI	Multi-ch	DSD	DSD up to 5.1ch	No output	2ch
		PCM	PCM up to 5.1ch	No output	2ch
	2-ch	DSD	DSD 2ch	No output	2ch
		PCM	PCM 2ch	No output	2ch
Analog	Multi-ch	DSD	No output	No output	2ch
		PCM	No output	No output	2ch
	2-ch	DSD	No output	No output	2ch
		PCM	No output	No output	2ch

■ About the HDMI video output formats

When TV System is set to NTSC

Contents	HDMI Resolution						
	Auto	Disc Native	1080p	1080i	720p	480p/576p	480i/576i
BD-Video with 1080p/24Hz content	*1	1080p 24Hz	1080p 24Hz/60Hz *3	1080i 60Hz	720p 60Hz	480p	480i
BD-Video without 1080p/24Hz content	*1	*2	1080p 60Hz	1080i 60Hz	720p 60Hz	480p	480i
DVD-Video	*1	*2	1080p 60Hz	1080i 60Hz	720p 60Hz	480p	480i
Others	*1	*1	1080p 60Hz	1080i 60Hz	720p 60Hz	480p	480i

When TV System is set to PAL

Contents	HDMI Resolution						
	Auto	Disc Native	1080p	1080i	720p	480p/576p	480i/576i
BD-Video with 1080p/24Hz content	*1	1080p 24Hz	1080p 24Hz/50Hz *3	1080i 50Hz	720p 50Hz	576p	576i
BD-Video without 1080p/24Hz content	*1	*2	1080p 50Hz	1080i 50Hz	720p 50Hz	576p	576i
DVD-Video	*1	*2	1080p 50Hz	1080i 50Hz	720p 50Hz	576p	576i
Others	*1	*1	1080p 50Hz	1080i 50Hz	720p 50Hz	576p	576i

*1 Resolution will be set to the maximum resolution supported by the connected TV. For example, when the maximum resolution supported by the connected TV is 1080p, the resolution will be set to 1080p.

*2 Resolution and frequency will be that of the source disc.

*3 If Auto is set for HDMI 1080p 24Hz and the connected TV supports 1080p 24Hz content, 1080p 24 Hz will be output instead of 1080p 50/60 Hz.

When TV System is set to Multi

When TV System is set to Multi, video signal is output at the same frequency as the source. Refer to the tables above for details on the frequency setting of the TV and resolution of the output video signal.

Notes

- HDMI 1080p 24Hz setting is disabled when output resolution is other than 1080p.
- When TV System is set to NTSC and video source is not 60 Hz, the video output signal is converted to 60 Hz.
- When TV System is set to PAL and video source is not 50 Hz, the video output signal is converted to 50 Hz.

Software upgrade

New software that provides additional features or product improvements will be released as needed. We recommend upgrading the software of this Player to the latest version periodically.

To check for the availability of a software upgrade, visit <http://download.yamaha.com/>

Note

- Do not remove the USB memory device, set this Player to standby mode or unplug the power cable/network cable while the software upgrade is being performed.

■ Upgrading the software

1. Prepare for the software upgrade.

When you upgrade the software from USB Storage:

- ① Save the upgrade file package to the appropriate folder on the USB memory device. For more details, refer to the procedure document attached with the upgrade file package.
- ② Connect the USB memory device.

When you upgrade the software from Network:
Confirm that this Player is connected to the network.

3. Upgrade the software by following the on-screen messages.

Upgrade is completed. The system will be reset.

2. Select the upgrade method and start upgrade from SETUP menu.

- ① Press **SETUP** to display SETUP menu screen.
- ② Select General Setting → System → Upgrade.
- ③ Select the item which contains the upgrade file package from USB Storage/Network.



The system will search for upgrade file package.







Troubleshooting

Refer to the table below when this Player does not function properly. If the problem you are experiencing is not listed below or if the instruction below does not help, turn off this Player, disconnect the power cable, and contact the nearest authorized Yamaha dealer or service center.

■ Power

Problem	Possible causes and solutions
No power.	<ul style="list-style-type: none"> – Connect the AC power cable properly. – Press  on the front panel to turn on the power.
The Player power is turned off.	<ul style="list-style-type: none"> – This Player will be automatically turned off after 20 minutes of inactivity (no playback) when Auto Power Standby (p. 34) is set to on.





■ Basic operation

Problem	Possible causes and solutions
The remote control does not work.	<ul style="list-style-type: none"> – Use the remote control within its operating range. (p. 11) – Replace the batteries. (p. 11) – Check the ID settings for the main unit and the remote control. The remote control ID on the main unit may be changed after the main unit is reset. In this case, verify the remote control ID on the main unit, and set it again if needed. (p. 11)
Buttons do not work.	<ul style="list-style-type: none"> – Press and hold  on the front panel for more than 5 seconds to reset this Player. – To completely reset this Player, unplug the power cable from the AC outlet for 30 seconds or more, plug the power cable to the AC outlet again, and then turn on this Player.
Password is forgotten.	<ul style="list-style-type: none"> – Press and hold , , , and  on the front panel simultaneously when no disc is inserted and playback is stopped to set all the settings including Security settings (p. 35) of this Player to their default settings. After the power is turned off automatically, press  to turn on the power again.

■ Disc playback

Problem	Possible causes and solutions
The disc tray does not open or close.	<ul style="list-style-type: none"> – The disc tray is locked when any network service is selected. Press HOME to exit from the network service (p. 22). – The disc tray is locked when this Player is in the <i>Bluetooth</i> or Miracast receiving mode. Press <i>Bluetooth</i> to exit from Bluetooth (p. 25), or Miracast to exit from Miracast (p. 26).
The Player cannot play a disc.	<ul style="list-style-type: none"> – Take out the disc and clean it. (p. 5) – Make sure that the disc is loaded properly (aligned in disc tray and label-side up). (p. 5) – Use a disc supported by the Player. (p. 3) – Remove the disc and then check whether the Player supports the disc or not. (p. 3) – Check the region code. (p. 3) – Check whether the disc is defective by trying another disc. – The CD-R/RW, DVD+R/RW/R DL, and DVD-R/RW/R DL must be finalized. (p. 3)
Video stops.	<ul style="list-style-type: none"> – The Player will stop if it senses shock or vibration.
The Player makes a snapping sound when starting playback or loading a disc.	<ul style="list-style-type: none"> – These sounds are not malfunctions of the Player but are normal operating conditions.
It takes time to start Blu-ray disc playback.	<ul style="list-style-type: none"> – This player searches for a USB memory device used as Local Storage for BD-Live feature (p. 30) when a Blu-ray disc is loaded. To reduce the waiting time, keep a USB memory device connected to the one of the USB connectors (front/rear) of this Player (p. 17).

Picture

Problem	Possible causes and solutions
No picture.	<ul style="list-style-type: none"> - Make sure that the cables are connected correctly. (p. 12) - Make sure that the connected TV or the AV receiver is set to the correct input. - With no disc inserted, or playback stopped, press and hold  and  on the front panel simultaneously to set video resolution to the default value. If a picture is still not output, press and hold  on the front panel for approximately 5 seconds to switch NTSC/PAL. - When set to Disc Native, a signal that is not compatible with the connected TV is output. Change the setting to output a signal that is compatible with the connected TV. (p. 37) - Make sure that the disc or file you are trying to play back is compatible with this Player (p. 3).
Screen freezes and operation buttons do not work.	<ul style="list-style-type: none"> - Press , then restart playback. - Turn off the power and turn on the power again. - Press and hold  on the front panel for more than 5 seconds to reset this Player.
Video is not output with the desired resolution.	<ul style="list-style-type: none"> - Set to the desired resolution. (p. 37)
Wide-screen video appears vertically stretched, or black bands appear at the top and bottom of the screen. Or 4:3 video appears horizontally stretched.	<ul style="list-style-type: none"> - Change the aspect ratio of your TV. (p. 37)
Square noise (mosaic) appears on the screen.	<ul style="list-style-type: none"> - Blocks in images may be visible in scenes with rapid movement due to the characteristics of digital image compression technology.

Sound

Problem	Possible causes and solutions
No sound, or sound is distorted.	<ul style="list-style-type: none"> - Check that the audio cable is connected correctly. (p. 12) - Turn the volume of TV or AV receiver up. - There is no sound during still mode, fast forward, and fast reverse. (p. 9) - Audio may not be output depending on the audio recording status, such as when audio other than an audio signal or non-standard audio is recorded for the audio content. (p. 3) - Make sure that the disc or file you are trying to play back is compatible with this Player (p. 3).
Left and right channels of audio are reversed, or sound comes out of only one side.	<ul style="list-style-type: none"> - Check the audio connection. (p. 14)
Cannot hear the desired audio type and/or number of channels.	<ul style="list-style-type: none"> - Refer to Audio Output setting and “About the audio output formats”. (p. 38, p. 40)
Cannot hear the sound of PIP (secondary audio).	<ul style="list-style-type: none"> - Set Coaxial / Optical or HDMI to PCM/Reencode. (p. 38) - To hear secondary audio, press 2ND AUDIO. (p. 9) - Depending on the disc, you may need to set secondary audio on the top menu of the disc. (p. 9)

■ Network

Problem	Possible causes and solutions
Cannot connect to the Internet.	<ul style="list-style-type: none"> – When connecting to the Internet by selecting Wired in Connection setting, connect the Network cable properly. (p. 36) – Turn on the connected equipment, such as broadband router or modem. – Connect the broadband router and/or modem properly. – If Wireless is selected in Connection setting, and when you want to connect to the Internet using Ethernet, select Wired properly. (p. 36) – Properly select Wireless in Connection setting when you want to connect to the Internet using a wireless LAN. (p. 36)
Cannot download BD-Live contents.	<ul style="list-style-type: none"> – Verify that this Player can connect to the Internet normally. Refer to “Connection Test”. (p. 36) – Connect USB memory device properly. Check that the USB memory device is connected to the USB connector of this Player. (p. 17) – Check if the Blu-ray Disc supports BD-Live. – Connect the USB memory device formatted in FAT16, FAT32, or NTFS. – It is recommended to connect the USB memory device with at least 2 GB of free space. If there is not enough free space, format the USB memory device. (p. 34) – Refer to the supplied user’s manual of the disc or consult the disc manufacturer.
Cannot detect the DLNA server.	<ul style="list-style-type: none"> – Verify that this Player can connect to the network normally. Refer to “Connection Test”. (p. 36) – Turn on the connected equipment, such as broadband router or the server. – Confirm the Player and the server are connected to the same router (or access point). – Depending on the DLNA server, the Player may need to be permitted from the server. – Depending on the DLNA server, it needs to change a firewall setting.
Cannot play the file on the DLNA server.	<ul style="list-style-type: none"> – Make sure the file is playable. (p. 3) – Check your DLNA server’s setting. – The playback and operating quality may be affected by your home network condition.
Cannot connect to the Internet via Wireless LAN.	<ul style="list-style-type: none"> – Make sure that the wireless LAN router is turned on. – Depending on the surrounding environment, such as the wall material, radio wave receiving condition, or obstacles between the Player and the wireless LAN router, the communication distance may be shortened. Move the Player and the wireless LAN router closer to each other. – Devices that use a 2.4 GHz frequency band, such as a microwave, <i>Bluetooth</i>, or digital cordless device, may interrupt the communication. Move the Player away from such devices, or turn off such devices. – If the Internet connection using a wireless LAN is still not successful by the above solutions, try using Ethernet by selecting Wired in Connection setting. (p. 36)
Wireless network is not found or distorted.	<ul style="list-style-type: none"> – Make sure that the wireless LAN router is turned on. – Move this Player closer to the router or change the orientation of this Player or the antenna of the wireless LAN router. – If the wireless connection cannot be configured using the WPS function, select another option (Scan or Manual) (p. 19). – Make sure that the wireless network is not disturbed by microwave ovens, digital cordless phones, or other neighboring Wi-Fi devices. – Microwave ovens, digital cordless phones or other wireless devices in your neighborhood might disturb the wireless network. Turn off these devices. – Make sure that the firewalls in your network allow access to the wireless connection of this Player. – If the wireless network does not work properly in your home, try the wired network connection.

■ Bluetooth

Problem	Possible causes and solutions
Cannot make the player paired with the <i>Bluetooth</i> device.	<ul style="list-style-type: none"> - Make sure you press Bluetooth and then RED to switch the Player to the pairing mode. - Perform pairing operations with a device which supports A2DP. - Use a <i>Bluetooth</i> device whose password is "0000". - Move the player and <i>Bluetooth</i> device closer to each other. - Devices that use a 2.4 GHz frequency band, such as a microwave, wireless LAN, or digital cordless device, may interrupt the communication. Move the Player away from such devices, or turn off such devices. - Another <i>Bluetooth</i> device is currently connected. Terminate current <i>Bluetooth</i> connection, and perform pairing with the new device (p. 24)
Cannot make a <i>Bluetooth</i> connection.	<ul style="list-style-type: none"> - Another <i>Bluetooth</i> device is currently connected. Terminate current <i>Bluetooth</i> connection, and make a connection with the new device. - More than nine devices are paired and the oldest pairing information is deleted. Perform pairing again (p. 24).
No sound is produced or the sound is interrupted during playback.	<ul style="list-style-type: none"> - The <i>Bluetooth</i> connection between the Player and <i>Bluetooth</i> device is terminated. Make a connection again (p. 25). - Move the player and <i>Bluetooth</i> device closer to each other. - Devices that use a 2.4 GHz frequency band, such as a microwave, wireless LAN, or digital cordless device, may interrupt the communication. Move the Player away from such devices, or turn off such devices. - Make sure that the <i>Bluetooth</i> function is enabled and set to send <i>Bluetooth</i> audio signals on the <i>Bluetooth</i> device. - Turn up the volume level on the <i>Bluetooth</i> device.

■ Messages on the screen

- The following messages appear on the TV screen in case the disc you tried to play back is not appropriate or the operation is not correct.

Error message	Possible causes and solutions
Unsupported File	- The file is not supported with this Player. See "Types of discs/files that can be used with this Player" (p. 3).
Wrong region code!	- The disc is an incompatible region code. See "Region management information for Blu-ray Disc/DVD videos" (p. 3).
Network has FAILED.	- This Player cannot be connected to the network. Check connection (p. 15) and Network setting (p. 36).
Network is OK, proxy has FAILED.	- This Player cannot be connected to the proxy server. See "Proxy Setting" (p. 36).
BD-Live connection is prohibited in SETUP menu.	- BD-Live connection is prohibited. See "BD-Live Connection" (p. 36).
Upgrade has failed for some reason!	- Upgrade is failed. Check if the upgrade file is corrupted or unreadable.
IP Setting is not valid! Please reset...	- The IP Setting entered is not valid. Enter the correct information again.

Glossary

AVCHD

AVCHD is a new format (standard) for high definition video cameras that can be used to record and play high-resolution HD images.

BD-Live™

BD-Live is a Blu-ray Disc standard that utilizes a network connection, enabling this Player to go online to download promotional videos and other data.

BDMV

BDMV (Blu-ray Disc Movie) refers to one of the application formats used for BD-ROM which is one of the Blu-ray Disc specifications. BDMV is a recording format equivalent to DVD-Video of the DVD specification.

Blu-ray 3D™

Blu-ray 3D enables you to view full high definition 3D images.

BONUSVIEW™

BONUSVIEW compatible discs let you simultaneously enjoy video sub-channel for two screens, audio sub-channel and sub-titles. A small screen appears within the main screen during playback (Picture in Picture).

Closed Caption

Closed captions are kind of subtitle, and the difference between subtitles and captions is that subtitles are intended for hearing persons and captions are for the hearing impaired. Subtitles rarely show all of the audio. For example, captions show sound effects (e.g., “phone ringing” and “footsteps”), while subtitles do not. Before you select this setting, please ensure that the disc contains closed caption information.

Color Space

Color Space is a color range that can be represented. RGB is a color space based on the RGB color model (red, green and blue) and is typically used for PC monitors. YCbCr is a color space based on a luminance signal (Y) and two color difference signals (Cb and Cr).

Deep Color

Deep Color refers to the use of various color depths in displays, up from the 24-bit depths in previous versions of the HDMI specification. This extra bit depth allows HDTVs and other displays go from millions of colors to billions of colors and eliminate on-screen color banding for smooth tonal transitions and subtle gradations between colors. The increased contrast ratio can represent many times more shades of gray between black and white. Also Deep Color increases the number of available colors within the boundaries defined by the RGB or YCbCr color space.

DLNA

DLNA (Digital Living Network Alliance) provides easy sharing of digital media through network in the home, and you can enjoy digital contents stored on your DLNA-server-software-installed PC or other DLNA compatible device with your TV via this Player. To connect this Player to your DLNA servers, some settings for the DLNA server or device are required. For details, refer to your DLNA server software or DLNA device.

DivX®

DivX® is a digital video format created by DivX, LLC, a subsidiary of Rovi Corporation. This is an official DivX Certified® device that plays DivX video. Visit divx.com for more information and software tools to convert your files into DivX videos.

Dolby Digital

A sound system developed by Dolby Laboratories Inc. that gives movie theater ambience to audio output when the product is connected to a Dolby Digital processor or amplifier.

Dolby Digital Plus

A sound system developed as an extension to Dolby Digital. This audio coding technology supports 7.1 multi-channel surround sound.

Dolby TrueHD

Dolby TrueHD is a lossless coding technology that supports up to 8 channels of multi-channel surround sound for the next generation optical discs. The reproduced sound is true to the original source bit-for-bit.

DRC (Dynamic Range Control)

DRC lets you adjust the range between the loudest and softest sounds (dynamic range) for playback at average volume. Use this when it is hard to hear dialog, or during times when playback may disturb neighbors.

DTS

This is a digital sound system developed by DTS, Inc. for use in cinemas.

DTS-HD High Resolution Audio

DTS-HD High Resolution Audio is a new technology developed for the next generation high definition optical disc format.

DTS-HD Master Audio

DTS-HD Master Audio is a lossless audio compression technology developed for the next generation high definition optical disc format.

FLAC

FLAC (Free Lossless Audio Codec) is an open file format for lossless audio data compression. While inferior in compression rate to other lossy compressed audio formats, it can often provide higher audio quality.

HDMI

HDMI (High-Definition Multimedia Interface) is an interface that supports both video and audio on a single digital connection. The HDMI connection carries standard to high definition video signals and multi-channel audio signals to AV components such as HDMI equipped TVs, in digital form without degradation.

Letterbox (LB 4:3)

A screen size with black bars on the top and bottom of the image to allow viewing of wide-screen (16:9) material on a connected 4:3 TV.

Linear PCM Sound

Linear PCM is a signal recording format used for Audio CDs and on some DVD and Blu-ray Discs. The sound on Audio CDs is recorded at 44.1 kHz with 16 bits. (Sound is recorded between 48 kHz with 16 bits and 96 kHz with 24 bits on DVD discs and between 48 kHz with 16 bits and 192 kHz with 24 bits on Blu-ray Discs.)

Mac address

The Mac address is a unique value assigned to a network device for identification purposes.

Pan Scan (PS 4:3)

A screen size that cuts off the sides of the image to allow viewing of wide-screen (16:9) material on a connected 4:3 TV.

Subtitles

These are the lines of text appearing at the bottom of the screen which translate or transcribe the dialog. They are recorded on many DVDs and Blu-ray Discs.

x.v.Color

x.v.Color reproduces a greater range of color than before, showing almost all of the colors that the human eye can detect.

Specifications

■ General

Power supply	
[U.S.A. and Canada models]	AC 120 V, 60 Hz
[Europe, Russia and Australia models]	
	AC 110–240 V, 50 Hz
[Asia, and Central and South America models]	
	AC 110–240 V, 50/60 Hz
[Other models]	AC 110–240 V, 60 Hz
Power consumption	19 W
Standby power consumption	
HDMI Control Off, Network Standby Off	0.2 W
HDMI Control On, Network Standby Off	0.3 W
HDMI Control Off, Network Standby On	
Wired	5.3 W
Wireless	5.0 W
HDMI Control On, Network Standby On	5.3 W
Dimensions (W × H × D, including protrusions)	435 × 86 × 258 mm (17-1/8 × 3-3/8 × 10-1/8 in)
Weight	2.9 kg (6.4 lbs.)

■ Audio performance

Audio output level (1 kHz, 0 dB)	
Blu-ray Disc/DVD/CD-DA	2 ± 0.3 V
Signal to noise ratio	
Blu-ray Disc/DVD/CD-DA	115 dB
Dynamic range	
Blu-ray Disc/DVD	110 dB
CD-DA	100 dB
Harmonic distortion (1 kHz)	
Blu-ray Disc/DVD/CD-DA	0.002%
Frequency Response	
Blu-ray Disc/DVD	4 Hz to 22 kHz (48 kHz Sampling)
	4 Hz to 44 kHz (96 kHz Sampling)
CD-DA	4 Hz to 20 kHz

■ Input/output

HDMI output	Type A connector × 1 480i/576i/480p/576p/720p/1080i/1080p/1080p@24Hz, Deep Color, x.v. Color support
Digital output	Optical × 1, Coaxial × 1
Analog audio output	Mixed 2 ch × 1
USB	Type A connector × 2
Wireless LAN	Standard: IEEE 802.11 b/g/n Frequency range: 2.4GHz band
Other equipment	Remote IN/OUT × 1 RS-232C × 1 (for custom installer) Ethernet × 1

Specifications are subject to change without notice.

■ Copyright

Note

- Audio-visual material may consist of copyrighted works which must not be recorded without the authority of the owner of the copyright. Refer to relevant laws in your country.



“Blu-ray Disc™”, “Blu-ray™”, “Blu-ray 3D™”, “BD-Live™”, “BONUSVIEW™”, and the logos are trademarks of the Blu-ray Disc Association.



DVD is a trademark of DVD Format/Logo Licensing Corporation.



Manufactured under license from Dolby Laboratories. Dolby and the double-D symbol are trademarks of Dolby Laboratories.



Manufactured under license under U.S. Patent Nos: 5,956,674; 5,974,380; 6,226,616; 6,487,535; 7,212,872; 7,333,929; 7,392,195; 7,272,567 & other U.S. and worldwide patents issued & pending. DTS-HD, the Symbol, & DTS-HD and the Symbol together are registered trademarks & DTS-HD Master Audio is a trademark of DTS, Inc.

Product includes software. © DTS, Inc. All Rights Reserved.



“HDMI,” the “HDMI” logo and High-Definition Multimedia Interface are trademarks or registered trademarks of HDMI Licensing LLC in the United States and other countries.

x.v.Color™

“x.v.Color” and “x.v.Color” logo are trademarks of Sony Corporation.



“AVCHD” and the “AVCHD” logo are trademarks of Panasonic Corporation and Sony Corporation.

Continued to the next page. ➔



Java is a registered trademark of Oracle and/or its affiliates.



Bluetooth is registered trademark of Bluetooth SIG.



DLNA™ and DLNA CERTIFIED™ are trademarks or registered trademarks of Digital Living Network Alliance. All rights reserved. Unauthorized use is strictly prohibited.



The Wi-Fi CERTIFIED Logo is a certification mark of the Wi-Fi Alliance.

The Wi-Fi Protected Setup Identifier Mark is a mark of the Wi-Fi Alliance.

“Wi-Fi”, “Wi-Fi Protected Setup”, “Wi-Fi Direct” and “Miracast” are marks or registered marks of the Wi-Fi Alliance.

This product is licensed under the AVC patent portfolio license and VC-1 patent portfolio license for the personal and non-commercial use of a consumer to (i) encode video in compliance with the AVC Standard and VC-1 Standard (“AVC/VC-1 Video”) and/or (ii) decode AVC/VC-1 Video that was encoded by a consumer engaged in a personal and non-commercial activity and/or was obtained from a video provider licensed to provide AVC/VC-1 Video. No license is granted or shall be implied for any other use. Additional information may be obtained from MPEG LA, LLC. See <http://www.mpegla.com>.

This product is licensed under the MVC patent portfolio license for the personal use of a consumer or other uses in which it does not receive remuneration to (i) encode video in compliance with the MVC Standard (“MVC Video”) and/or (ii) decode MVC Video that was encoded by a consumer engaged in a personal activity and/or was obtained from a video provider licensed to provide MVC Video. No license is granted or shall be implied for any other use. Additional information may be obtained from MPEG LA, LLC. See <http://www.mpegla.com>

Windows Media Player is a registered trademark or trademark of Microsoft corporation in the United States and/or other countries

Copyright 2004-2012 Verance Corporation. Cinavia® is a Verance Corporation trademark. Protected by U.S. Patent 7,369,677 and worldwide patents issued and pending under license from Verance Corporation. All rights reserved.



DivX®, DivX Certified®, DivX Plus® HD and associated logos are trademarks of Rovi Corporation or its subsidiaries and are used under license.

DivX Certified® to play DivX® and DivX Plus® HD (H.264/MKV) video up to 1080p HD including premium content.

ABOUT DIVX VIDEO: DivX® is a digital video format created by DivX, LLC, a subsidiary of Rovi Corporation. This is an official DivX Certified® device that has passed rigorous testing to verify that it plays DivX video. Visit divx.com for more information and software tools to convert your files into DivX videos.

ABOUT DIVX VIDEO-ON-DEMAND: This DivX Certified® device must be registered in order to play purchased DivX Video-on-Demand (VOD) movies. To obtain your registration code, locate the DivX VOD section in your device setup menu. Go to vod.divx.com for more information on how to complete your registration.

Index

■ Numerics

2ch Downmix, SETUP menu	39
2ND AUDIO, remote control	9
3D Output, SETUP menu	37
3D Playback Message, SETUP menu	34

■ A

A/B, remote control	9
Angle Mark, SETUP menu	35
Angle, On Screen menu	27
ANGLE, remote control	9
Audio output formats	40
Audio Output, SETUP menu	38
Audio Setting, SETUP menu	38
Audio, On Screen menu	27
AUDIO, remote control	9
Audio, SETUP menu	34
Auto Power Standby, SETUP menu	34
AV CONTROLLER	26

■ B

BD-Live	30
BD-Live Connection, SETUP menu	36
Bitrate, On Screen menu	27
Bluetooth	24

■ C

CC Select, On Screen menu	27
Change Password, SETUP menu	35
Chapter, On Screen menu	27
CLEAR, remote control	8
Closed Caption, SETUP menu	38
Coaxial / Optical, SETUP menu	38
Code Page, On Screen menu	27
Color buttons, remote control	8
Color Space, SETUP menu	37
Connection Setting, SETUP menu	36
Connection Test, SETUP menu	36
Control buttons, remote control	9
Country Code, SETUP menu	35
Cursor buttons, remote control	9

■ D

Data disc playback	20
De-interlacing Mode, SETUP menu	38
Digital Media Controller (DMC)	16
Disc Auto Playback, SETUP menu	35
Display Setting, SETUP menu	37
DivX(R) VOD DRM, SETUP menu	35
DLNA	16
Downsampling, SETUP menu	38
DRC, SETUP menu	38
Dropbox	23

■ E

Easy Setup, SETUP menu	34
ENTER, remote control	9

■ G

General Setting, SETUP menu	34
-----------------------------------	----

■ H

HDMI 1080p 24Hz, SETUP menu	38
HDMI Control function	34
HDMI Control, SETUP menu	34
HDMI Deep Color, SETUP menu	37
HDMI Output	39
HDMI, SETUP menu	38
HOME, remote control	9

■ I

Information, SETUP menu	36
Ins Replay, On Screen menu	27
Ins Search, On Screen menu	27
IP Setting, SETUP menu	36

■ L

Language, SETUP menu	34
Last Memory, SETUP menu	35
Load Default, SETUP menu	34
Local Storage, SETUP menu	34

■ M

Menu, SETUP menu	34
Miracast	26
Mode/Play Mode, On Screen menu	27

■ N

Network Control, SETUP menu	36
Network, SETUP menu	36
Noise Reduction, SETUP menu	38
Number buttons, remote control	8

■ O

On Screen menu	27
ON SCREEN, remote control	10
OSD, SETUP menu	34
Other connections	18
Output Priority	39

■ P

Parental Control, SETUP menu	35
PBC (Push Button Configuration)	36
Picasa Web Albums	23
Picture in Picture function	30
PIN code (WPS)	36
PIP Mark, SETUP menu	35
PIP, remote control	8
Playback, SETUP menu	35
POP UP/MENU, remote control	10
Post Process, SETUP menu	39
Program play	29
PROGRAM, remote control	8
Proxy Setting, SETUP menu	36
PURE DIRECT	10

■ R

Remote control	8
REPEAT, remote control	8
RETURN, remote control	9

■ S

SACD Output, SETUP menu	39
Search function	29
SEARCH, remote control	9
Second Audio, On Screen menu	27
Second Video, On Screen menu	27
Secondary Audio Mark, SETUP menu	35
Security, SETUP menu	35
SETUP menu	31
SETUP menu operation	33
SETUP, remote control	9
SHUFFLE, remote control	8
Slide Show, On Screen menu	27
Software upgrade	42
Speaker Setting, SETUP menu	39
Status menu	28
STATUS, remote control	9
Subtitle Style, On Screen menu	27
Subtitle, On Screen menu	27
SUBTITLE, remote control	9
Subtitle, SETUP menu	35
System Information, SETUP menu	39
System, SETUP menu	34

■ T

Time, On Screen menu	27
Title, On Screen menu	27
TOP MENU, remote control	9
Track/File, On Screen menu	27
Transition, On Screen menu	27
TV Screen, SETUP menu	37
TV System, SETUP menu	37
TV, SETUP menu	37

■ U

Upgrade Notification	34
Upgrade of software	42
Upgrade, SETUP menu	34
UpMix, SETUP menu	39
USB content playback	20

■ V

Video output formats	41
Video Process, SETUP menu	38

■ W

WPS (Wi-Fi Protected Setup)	36
-----------------------------------	----

■ Y

YouTube	23
---------------	----

■ Z

ZOOM, remote control	8
----------------------------	---

Information about third party software licenses

This product incorporates the following third party software.

For information (copyright, etc) about each software, please read the terms and conditions stated below. By using this product, you will be deemed to have accepted the terms and conditions.

■ **About Linux kernel, D-Bus, cpio, samba, SquashFS, iputils, udhccp, net-tools, iproute2, dibbler, sysvinit, module-init-tools, util-linux-ng, psmisc, coreutils, gawk, grep, findutils, bash, tar, sed, gzip, inetutils, gdb (gdbserver), mtd-util, Wireless Tools, Fusion, msdl, e2fsprogs, gconv, oprofile, ntfsp, nftsp, nftsp, which, libl**

GNU GENERAL PUBLIC LICENSE
Version 2, June 1991

Copyright © 1989, 1991 Free Software Foundation, Inc.
51 Franklin St, Fifth Floor, Boston, MA 02110-1301 USA

Everyone is permitted to copy and distribute verbatim copies of this license document, but changing it is not allowed.

Preamble

The licenses for most software are designed to take away your freedom to share and change it. By contrast, the GNU General Public License is intended to guarantee your freedom to share and change free software--to make sure the software is free for all its users. This General Public License applies to most of the Free Software Foundation's software and to any other program whose authors commit to using it. (Some other Free Software Foundation software is covered by the GNU Library General Public License instead.) You can apply it to your programs, too.

When we speak of free software, we are referring to freedom, not price. Our General Public Licenses are designed to make sure that you have the freedom to distribute copies of free software (and charge for this service if you wish), that you receive source code or can get it if you want it, that you can change the software or use pieces of it in new free programs; and that you know you can do these things.

To protect your rights, we need to make restrictions that forbid anyone to deny you these rights or to ask you to surrender the rights. These restrictions translate to certain responsibilities for you if you distribute copies of the software, or if you modify it.

For example, if you distribute copies of such a program, whether gratis or for a fee, you must give the recipients all the rights that you have. You must make sure that they, too, receive or can get the source code. And you must show them these terms so they know their rights.

We protect your rights with two steps: (1) copyright the software, and (2) offer you this license which gives you legal permission to copy, distribute and/or modify the software.

Also, for each author's protection and ours, we want to make certain that everyone understands that there is no warranty for this free software. If the software is modified by someone else and passed on, we want its recipients to know that what they have is not the original, so that any problems introduced by others will not reflect on the original authors' reputations.

Finally, any free program is threatened constantly by software patents. We wish to avoid the danger that redistributors of a free program will individually obtain patent licenses, in effect making the program proprietary. To prevent this, we have made it clear that any patent must be licensed for everyone's free use or not licensed at all.

The precise terms and conditions for copying, distribution and modification follow.

GNU GENERAL PUBLIC LICENSE TERMS AND CONDITIONS FOR COPYING, DISTRIBUTION AND MODIFICATION

0. This License applies to any program or other work which contains a notice placed by the copyright holder saying it may be distributed under the terms of this General Public License. The "Program", below, refers to any such program or work, and a "work based on the Program" means either the Program or any derivative work under copyright law: that is to say, a work containing the Program or a portion of it, either verbatim or with modifications and/or translated into another language. (Hereinafter, translation is included without limitation in the term "modification".) Each licensee is addressed as "you".

Activities other than copying, distribution and modification are not covered by this License; they are outside its scope. The act of running the Program is not restricted, and the output from the Program is covered only if its contents constitute a work based on the Program (independent of having been made by running the Program). Whether that is true depends on what the Program does.

1. You may copy and distribute verbatim copies of the Program's source code as you receive it, in any medium, provided that you conspicuously and appropriately publish on each copy an appropriate copyright notice and disclaimer of warranty; keep intact all the notices that refer to this License and to the absence of any warranty; and give any other recipients of the Program a copy of this License along with the Program.
You may charge a fee for the physical act of transferring a copy, and you may at your option offer warranty protection in exchange for a fee.

2. You may modify your copy or copies of the Program or any portion of it, thus forming a work based on the Program, and copy and distribute such modifications or work under the terms of Section 1 above, provided that you also meet all of these conditions:

- You must cause the modified files to carry prominent notices stating that you changed the files and the date of any change.
- You must cause any work that you distribute or publish, that in whole or in part contains or is derived from the Program or any part thereof, to be licensed as a whole at no charge to all third parties under the terms of this License.

- If the modified program normally reads commands interactively when run, you must cause it, when started running for such interactive use in the most ordinary way, to print or display an announcement including an appropriate copyright notice and a notice that there is no warranty (or else, saying that you provide a warranty) and that users may redistribute the program under these conditions, and telling the user how to view a copy of this License. (Exception: if the Program itself is interactive but does not normally print such an announcement, your work based on the Program is not required to print an announcement.)

These requirements apply to the modified work as a whole. If identifiable sections of that work are not derived from the Program, and can be reasonably considered independent and separate works in themselves, then this License, and its terms, do not apply to those sections when you distribute them as separate works. But when you distribute the same sections as part of a whole which is a work based on the Program, the distribution of the whole must be on the terms of this License, whose permissions for other licensees extend to the entire whole, and thus to each and every part regardless of who wrote it.

Thus, it is not the intent of this section to claim rights or contest your rights to work written entirely by you; rather, the intent is to exercise the right to control the distribution of derivative or collective works based on the Program.

In addition, mere aggregation of another work not based on the Program with the Program (or with a work based on the Program) on a volume of a storage or distribution medium does not bring the other work under the scope of this License.

3. You may copy and distribute the Program (or a work based on it, under Section 2) in object code or executable form under the terms of Sections 1 and 2 above provided that you also do one of the following:

- Accompany it with the complete corresponding machine-readable source code, which must be distributed under the terms of Sections 1 and 2 above on a medium customarily used for software interchange; or,
- Accompany it with a written offer, valid for at least three years, to give any third party, for a charge no more than your cost of physically performing source distribution, a complete machine-readable copy of the corresponding source code, to be distributed under the terms of Sections 1 and 2 above on a medium customarily used for software interchange; or,
- Accompany it with the information you received as to the offer to distribute corresponding source code. (This alternative is allowed only for noncommercial distribution and only if you received the program in object code or executable form with such an offer, in accord with Subsection b above.)

The source code for a work means the preferred form of the work for making modifications to it. For an executable work, complete source code means all the source code for all modules it contains, plus any associated interface definition files, plus the scripts used to control compilation and installation of the executable. However, as a special exception, the source code distributed need not include anything that is normally distributed (in either source or binary form) with the major components (compiler, kernel, and so on) of the operating system on which the executable runs, unless that component itself accompanies the executable.

If distribution of executable or object code is made by offering access to copy from a designated place, then offering equivalent access to copy the source code from the same place counts as distribution of the source code, even though third parties are not compelled to copy the source along with the object code.

- You may not copy, modify, sublicense, or distribute the Program except as expressly provided under this License. Any attempt otherwise to copy, modify, sublicense or distribute the Program is void, and will automatically terminate your rights under this License. However, parties who have received copies, or rights, from you under this License will not have their licenses terminated so long as such parties remain in full compliance.
- You are not required to accept this License, since you have not signed it. However, nothing else grants you permission to modify or distribute the Program or its derivative works. These actions are prohibited by law if you do not accept this License. Therefore, by modifying or distributing the Program (or any work based on the Program), you indicate your acceptance of this License to do so, and all its terms and conditions for copying, distributing or modifying the Program or works based on it.
- Each time you redistribute the Program (or any work based on the Program), the recipient automatically receives a license from the original licensor to copy, distribute or modify the Program subject to these terms and conditions. You may not impose any further restrictions on the recipients' exercise of the rights granted herein. You are not responsible for enforcing compliance by third parties to this License.
- If, as a consequence of a court judgment or allegation of patent infringement or for any other reason (not limited to patent issues), conditions are imposed on you (whether by court order, agreement or otherwise) that contradict the conditions of this License, they do not excuse you from the conditions of this License. If you cannot distribute so as to satisfy simultaneously your obligations under this License and any other pertinent obligations, then as a consequence you may not distribute the Program at all. For example, if a patent license would not permit royalty-free redistribution of the Program by all those who receive copies directly or indirectly through you, then the only way you could satisfy both it and this License would be to refrain entirely from distribution of the Program.

If any portion of this section is held invalid or unenforceable under any particular circumstance, the balance of the section is intended to apply and the section as a whole is intended to apply in other circumstances.

It is not the purpose of this section to induce you to infringe any patents or other property right claims or to contest validity of any such claims; this section has the sole purpose of protecting the integrity of the free software distribution system, which is implemented by public license practices. Many people have made generous contributions to the wide range of software distributed through that system in reliance on consistent application of that system; it is up to the author/donor to decide if he or she is willing to distribute software through any other system and a licensee cannot impose that choice.

This section is intended to make thoroughly clear what is believed to be a consequence of the rest of this License.

- If the distribution and/or use of the Program is restricted in certain countries either by patents or by copyrighted interfaces, the original copyright holder who places the Program under this License may add an explicit geographical distribution limitation excluding those countries, so that distribution is permitted only in or among countries not thus excluded. In such case, this License incorporates the limitation as if written in the body of this License.
- The Free Software Foundation may publish revised and/or new versions of the General Public License from time to time. Such new versions will be similar in spirit to the present version, but may differ in detail to address new problems or concerns.

Each version is given a distinguishing version number. If the Program specifies a version number of this License which applies to it and "any later version", you have the option of following the terms and conditions either of that version or of any later version published by the Free Software Foundation. If the Program does not specify a version number of this License, you may choose any version ever published by the Free Software Foundation.

- If you wish to incorporate parts of the Program into other free programs whose distribution conditions are different, write to the author to ask for permission. For software which is copyrighted by the Free Software Foundation, write to the Free Software Foundation; we sometimes make exceptions for this. Our decision will be guided by the two goals of preserving the free status of all derivatives of our free software and of promoting the sharing and reuse of software generally.

NO WARRANTY

- BECAUSE THE PROGRAM IS LICENSED FREE OF CHARGE, THERE IS NO WARRANTY FOR THE PROGRAM, TO THE EXTENT PERMITTED BY APPLICABLE LAW. EXCEPT WHEN OTHERWISE STATED IN WRITING THE COPYRIGHT HOLDERS AND/OR OTHER PARTIES PROVIDE THE PROGRAM "AS IS" WITHOUT WARRANTY OF ANY KIND, EITHER EXPRESSED OR IMPLIED, INCLUDING, BUT NOT LIMITED TO, THE IMPLIED WARRANTIES OF MERCHANTABILITY AND FITNESS FOR A PARTICULAR PURPOSE. THE ENTIRE RISK AS TO THE QUALITY AND PERFORMANCE OF THE PROGRAM IS WITH YOU. SHOULD THE PROGRAM PROVE DEFECTIVE, YOU ASSUME THE COST OF ALL NECESSARY SERVICING, REPAIR OR CORRECTION.
- IN NO EVENT UNLESS REQUIRED BY APPLICABLE LAW OR AGREED TO IN WRITING WILL ANY COPYRIGHT HOLDER, OR ANY OTHER PARTY WHO MAY MODIFY AND/OR REDISTRIBUTE THE PROGRAM AS PERMITTED ABOVE, BE LIABLE TO YOU FOR DAMAGES, INCLUDING ANY GENERAL, SPECIAL, INCIDENTAL OR CONSEQUENTIAL DAMAGES ARISING OUT OF THE USE OR INABILITY TO USE THE PROGRAM (INCLUDING BUT NOT LIMITED TO LOSS OF DATA OR DATA BEING RENDERED INACCURATE OR LOSSES SUSTAINED BY YOU OR THIRD PARTIES OR A FAILURE OF THE PROGRAM TO OPERATE WITH ANY OTHER PROGRAMS), EVEN IF SUCH HOLDER OR OTHER PARTY HAS BEEN ADVISED OF THE POSSIBILITY OF SUCH DAMAGES.

END OF TERMS AND CONDITIONS

How to Apply These Terms to Your New Programs

If you develop a new program, and you want it to be of the greatest possible use to the public, the best way to achieve this is to make it free software which everyone can redistribute and change under these terms.

To do so, attach the following notices to the program. It is safest to attach them to the start of each source file to most effectively convey the exclusion of warranty; and each file should have at least the "copyright" line and a pointer to where the full notice is found.

```
<one line to give the program's name and a brief idea of what it does.>
Copyright © <year> <name of author>
```

This program is free software; you can redistribute it and/or modify it under the terms of the GNU General Public License as published by the Free Software Foundation; either version 2 of the License, or (at your option) any later version.

This program is distributed in the hope that it will be useful, but WITHOUT ANY WARRANTY; without even the implied warranty of MERCHANTABILITY or FITNESS FOR A PARTICULAR PURPOSE. See the GNU General Public License for more details.

You should have received a copy of the GNU General Public License along with this program; if not, write to the Free Software Foundation, Inc., 51 Franklin St, Fifth Floor, Boston, MA 02110-1301 USA

Also add information on how to contact you by electronic and paper mail.

If the program is interactive, make it output a short notice like this

when it starts in an interactive mode:

```
Gnomovision version 69, Copyright © year name of author Gnomovision comes
with ABSOLUTELY NO WARRANTY; for details type 'show w'. This is free
software, and you are welcome to redistribute it under certain conditions; type
'show c' for details.
```

The hypothetical commands 'show w' and 'show c' should show the appropriate parts of the General Public License. Of course, the commands you use may be called something other than 'show w' and 'show c'; they could even be mouse-clicks or menu items--whatever suits your program.

You should also get your employer (if you work as a programmer) or your school, if any, to sign a "copyright disclaimer" for the program, if necessary. Here is a sample; alter the names:

```
Yoyodyne, Inc., hereby disclaims all copyright interest in the program
'Gnomovision' (which makes passes at compilers) written by James Hacker.
```

```
<signature of Ty Coon>, 1 April 1989
```

```
Ty Coon, President of Vice
```

This General Public License does not permit incorporating your program into proprietary programs. If your program is a subroutine library, you may consider it more useful to permit linking proprietary applications with the library. If this is what you want to do, use the GNU Library General

Public License instead of this License.

■ About gcc libgcc, gcc libstdc++

GNU GENERAL PUBLIC LICENSE

Version 3, 29 June 2007

Copyright © 2007 Free Software Foundation, Inc. <<http://fsf.org/>>

Everyone is permitted to copy and distribute verbatim copies of this license document, but changing it is not allowed.

Preamble

The GNU General Public License is a free, copyleft license for software and other kinds of works.

The licenses for most software and other practical works are designed to take away your freedom to share and change the works. By contrast, the GNU General Public License is intended to guarantee your freedom to share and change all versions of a program--to make sure it remains free software for all its users. We, the Free Software Foundation, use the GNU General Public License for most of our software; it applies also to any other work released this way by its authors. You can apply it to your programs, too.

When we speak of free software, we are referring to freedom, not price. Our General Public Licenses are designed to make sure that you have the freedom to distribute copies of free software (and charge for them if you wish), that you receive source code or can get it if you want it, that you can change the software or use pieces of it in new free programs, and that you know you can do these things.

To protect your rights, we need to prevent others from denying you these rights or asking you to surrender the rights. Therefore, you have certain responsibilities if you distribute copies of the software, or if you modify it: responsibilities to respect the freedom of others.

For example, if you distribute copies of such a program, whether gratis or for a fee, you must pass on to the recipients the same freedoms that you received. You must make sure that they, too, receive or can get the source code. And you must show them these terms so they know their rights.

Developers that use the GNU GPL protect your rights with two steps:

- assert copyright on the software, and
- offer you this License giving you legal permission to copy, distribute and/or modify it.

For the developers' and authors' protection, the GPL clearly explains that there is no warranty for this free software. For both users' and authors' sake, the GPL requires that modified versions be marked as changed, so that their problems will not be attributed erroneously to authors of previous versions.

Some devices are designed to deny users access to install or run modified versions of the software inside them, although the manufacturer can do so. This is fundamentally incompatible with the aim of protecting users' freedom to change the software. The systematic pattern of such abuse occurs in the area of products for individuals to use, which is precisely where it is most unacceptable. Therefore, we have designed this version of the GPL to prohibit the practice for those products. If such problems arise substantially in other domains, we stand ready to extend this provision to those domains in future versions of the GPL, as needed to protect the freedom of users.

Finally, every program is threatened constantly by software patents. States should not allow patents to restrict development and use of software on general-purpose computers, but in those that do, we wish to avoid the special danger that patents applied to a free program could make it effectively proprietary. To prevent this, the GPL assures that patents cannot be used to render the program non-free.

The precise terms and conditions for copying, distribution and modification follow.

TERMS AND CONDITIONS

0. Definitions.

"This License" refers to version 3 of the GNU General Public License.

"Copyright" also means copyright-like laws that apply to other kinds of works, such as semiconductor masks.

"The Program" refers to any copyrightable work licensed under this License. Each licensee is addressed as "you". "Licensees" and "recipients" may be individuals or organizations.

To "modify" a work means to copy from or adapt all or part of the work in a fashion requiring copyright permission, other than the making of an exact copy. The resulting work is called a "modified version" of the earlier work or a work "based on" the earlier work.

A "covered work" means either the unmodified Program or a work based on the Program.

To "propagate" a work means to do anything with it that, without permission, would make you directly or secondarily liable for infringing under applicable copyright law, except executing it on a computer or modifying a private copy. Propagation includes copying, distribution (with or without modification), making available to the public, and in some countries other activities as well.

To “convey” a work means any kind of propagation that enables other parties to make or receive copies. Mere interaction with a user through a computer network, with no transfer of a copy, is not conveying.

An interactive user interface displays “Appropriate Legal Notices” to the extent that it includes a convenient and prominently visible feature that (1) displays an appropriate copyright notice, and (2) tells the user that there is no warranty for the work (except to the extent that warranties are provided), that licensees may convey the work under this License, and how to view a copy of this License. If the interface presents a list of user commands or options, such as a menu, a prominent item in the list meets this criterion.

1. Source Code.

The “source code” for a work means the preferred form of the work for making modifications to it. “Object code” means any non-source form of a work.

A “Standard Interface” means an interface that either is an official standard defined by a recognized standards body, or, in the case of interfaces specified for a particular programming language, one that is widely used among developers working in that language.

The “System Libraries” of an executable work include anything, other than the work as a whole, that (a) is included in the normal form of packaging a Major Component, but which is not part of that Major Component, and (b) serves only to enable use of the work with that Major Component, or to implement a Standard Interface for which an implementation is available to the public in source code form. A “Major Component”, in this context, means a major essential component (kernel, window system, and so on) of the specific operating system (if any) on which the executable work runs, or a compiler used to produce the work, or an object code interpreter used to run it.

The “Corresponding Source” for a work in object code form means all the source code needed to generate, install, and (for an executable work) run the object code and to modify the work, including scripts to control those activities. However, it does not include the work’s System Libraries, or general-purpose tools or generally available free programs which are used unmodified in performing those activities but which are not part of the work. For example, Corresponding Source includes interface definition files associated with source files for the work, and the source code for shared libraries and dynamically linked subprograms that the work is specifically designed to require, such as by intimate data communication or control flow between those subprograms and other parts of the work.

The Corresponding Source need not include anything that users can regenerate automatically from other parts of the Corresponding Source.

The Corresponding Source for a work in source code form is that same work.

2. Basic Permissions.

All rights granted under this License are granted for the term of copyright on the Program, and are irrevocable provided the stated conditions are met. This License explicitly affirms your unlimited permission to run the unmodified Program. The output from running a covered work is covered by this License only if the output, given its content, constitutes a covered work. This License acknowledges your rights of fair use or other equivalent, as provided by copyright law.

You may make, run and propagate covered works that you do not convey, without conditions so long as your license otherwise remains in force. You may convey covered works to others for the sole purpose of having them make modifications exclusively for you, or provide you with facilities for running those works, provided that you comply with the terms of this License in conveying all material for which you do not control copyright. Those thus making or running the covered works for you must do so exclusively on your behalf, under your direction and control, on terms that prohibit them from making any copies of your copyrighted material outside their relationship with you.

Conveying under any other circumstances is permitted solely under the conditions stated below. Sublicensing is not allowed; section 10 makes it unnecessary.

3. Protecting Users’ Legal Rights From Anti-Circumvention Law.

No covered work shall be deemed part of an effective technological measure under any applicable law fulfilling obligations under article 11 of the WIPO copyright treaty adopted on 20 December 1996, or similar laws prohibiting or restricting circumvention of such measures.

When you convey a covered work, you waive any legal power to forbid circumvention of technological measures to the extent such circumvention is effected by exercising rights under this License with respect to the covered work, and you disclaim any intention to limit operation or modification of the work as a means of enforcing, against the work’s users, your or third parties’ legal rights to forbid circumvention of technological measures.

4. Conveying Verbatim Copies.

You may convey verbatim copies of the Program’s source code as you receive it, in any medium, provided that you conspicuously and appropriately publish on each copy an appropriate copyright notice; keep intact all notices stating that this License and any non-permissive terms added in accord with section 7 apply to the code; keep intact all notices of the absence of any warranty; and give all recipients a copy of this License along with the Program.

You may charge any price or no price for each copy that you convey, and you may offer support or warranty protection for a fee.

5. Conveying Modified Source Versions.

You may convey a work based on the Program, or the modifications to produce it from the Program, in the form of source code under the terms of section 4, provided that you also meet all of these conditions:

a) The work must carry prominent notices stating that you modified it, and giving a relevant date.

b) The work must carry prominent notices stating that it is released under this License and any conditions added under section

7. This requirement modifies the requirement in section 4 to “keep intact all notices”.

c) You must license the entire work, as a whole, under this License to anyone who comes into possession of a copy. This License will therefore apply, along with any applicable section 7 additional terms, to the whole of the work, and all its parts, regardless of how they are packaged. This License gives no permission to license the work in any other way, but it does not invalidate such permission if you have separately received it.

d) If the work has interactive user interfaces, each must display Appropriate Legal Notices; however, if the Program has interactive interfaces that do not display Appropriate Legal Notices, your work need not make them do so.

A compilation of a covered work with other separate and independent works, which are not by their nature extensions of the covered work, and which are not combined with it such as to form a larger program, in or on a volume of a storage or distribution medium, is called an “aggregate” if the compilation and its resulting copyright are not used to limit the access or legal rights of the compilation’s users beyond what the individual works permit. Inclusion of a covered work in an aggregate does not cause this License to apply to the other parts of the aggregate.

6. Conveying Non-Source Forms.

You may convey a covered work in object code form under the terms of sections 4 and 5, provided that you also convey the machine-readable Corresponding Source under the terms of this License, in one of these ways:

a) Convey the object code in, or embodied in, a physical product (including a physical distribution medium), accompanied by the Corresponding Source fixed on a durable physical medium customarily used for software interchange.

b) Convey the object code in, or embodied in, a physical product (including a physical distribution medium), accompanied by a written offer, valid for at least three years and valid for as long as you offer spare parts or customer support for that product model, to give anyone who possesses the object code either (1) a copy of the Corresponding Source for all the software in the product that is covered by this License, on a durable physical medium customarily used for software interchange, for a price no more than your reasonable cost of physically performing this conveying of source, or (2) access to copy the Corresponding Source from a network server at no charge.

c) Convey individual copies of the object code with a copy of the written offer to provide the Corresponding Source. This alternative is allowed only occasionally and noncommercially, and only if you received the object code with such an offer, in accord with subsection 6b.

d) Convey the object code by offering access from a designated place (gratis or for a charge), and offer equivalent access to the Corresponding Source in the same way through the same place at no further charge. You need not require recipients to copy the Corresponding Source along with the object code. If the place to copy the object code is a network server, the Corresponding Source may be on a different server (operated by you or a third party) that supports equivalent copying facilities, provided you maintain clear directions next to the object code saying where to find the Corresponding Source. Regardless of what server hosts the Corresponding Source, you remain obligated to ensure that it is available for as long as needed to satisfy these requirements.

e) Convey the object code using peer-to-peer transmission, provided you inform other peers where the object code and Corresponding Source of the work are being offered to the general public at no charge under subsection 6d.

A separable portion of the object code, whose source code is excluded from the Corresponding Source as a System Library, need not be included in conveying the object code work.

A “User Product” is either (1) a “consumer product”, which means any tangible personal property which is normally used for personal, family, or household purposes, or (2) anything designed or sold for incorporation into a dwelling. In determining whether a product is a consumer product, doubtful cases shall be resolved in favor of coverage. For a particular product received by a particular user, “normally used” refers to a typical or common use of that class of product, regardless of the status of the particular user or of the way in which the particular user actually uses, or expects or is expected to use, the product. A product is a consumer product regardless of whether the product has substantial commercial, industrial or non-consumer uses, unless such uses represent the only significant mode of use of the product.

“Installation Information” for a User Product means any methods, procedures, authorization keys, or other information required to install and execute modified versions of a covered work in that User Product from a modified version of its Corresponding Source. The information must suffice to ensure that the continued functioning of the modified object code is in no case prevented or interfered with solely because modification has been made.

If you convey an object code work under this section in, or with, or specifically for use in, a User Product, and the conveying occurs as part of a transaction in which the right of possession and use of the User Product is transferred to the recipient in perpetuity or for a fixed term (regardless of how the transaction is characterized), the Corresponding Source conveyed under this section must be accompanied by the Installation Information. But this requirement does not apply if neither you nor any third party retains the ability to install modified object code on the User Product (for example, the work has been installed in ROM).

The requirement to provide Installation Information does not include a requirement to continue to provide support service, warranty, or updates for a work that has been modified or installed. Access to a network may be denied when the modification itself materially and adversely affects the operation of the network or violates the rules and protocols for communication across the network.

Corresponding Source conveyed, and Installation Information provided, in accord with this section must be in a format that is publicly documented (and with an implementation available to the public in source code form), and must require no special password or key for unpacking, reading or copying.

7. Additional Terms.

“Additional permissions” are terms that supplement the terms of this License by making exceptions from one or more of its conditions. Additional permissions that are applicable to the entire Program shall be treated as though they were included in this License, to the extent that they are valid under applicable law. If additional permissions apply only to part of the Program, that part may be used separately under those permissions, but the entire Program remains governed by this License without regard to the additional permissions.

When you convey a copy of a covered work, you may at your option remove any additional permissions from that copy, or from any part of it. (Additional permissions may be written to require their own removal in certain cases when you modify the work.) You may place additional permissions on material, added by you to a covered work, for which you have or can give appropriate copyright permission.

Notwithstanding any other provision of this License, for material you add to a covered work, you may (if authorized by the copyright holders of that material) supplement the terms of this License with terms:

a) Disclaiming warranty or limiting liability differently from the terms of sections 15 and 16 of this License; or

b) Requiring preservation of specified reasonable legal notices or author attributions in that material or in the Appropriate Legal Notices displayed by works containing it; or

c) Prohibiting misrepresentation of the origin of that material, or requiring that modified versions of such material be marked in reasonable ways as different from the original version; or

d) Limiting the use for publicity purposes of names of licensors or authors of the material; or

e) Declining to grant rights under trademark law for use of some trade names, trademarks, or service marks; or

f) Requiring indemnification of licensors and authors of that material by anyone who conveys the material (or modified versions of it) with contractual assumptions of liability to the recipient, for any liability that these contractual assumptions directly impose on those licensors and authors.

All other non-permissive additional terms are considered “further restrictions” within the meaning of section 10. If the Program as you received it, or any part of it, contains a notice stating that it is governed by this License along with a term that is a further restriction, you may remove that term. If a license document contains a further restriction but permits relicensing or conveying under this License, you may add a covered work material governed by the terms of that license document, provided that the further restriction does not survive such relicensing or conveying.

If you add terms to a covered work in accord with this section, you must place, in the relevant source files, a statement of the additional terms that apply to those files, or a notice indicating where to find the applicable terms.

Additional terms, permissive or non-permissive, may be stated in the form of a separately written license, or stated as exceptions; the above requirements apply either way.

8. Termination.

You may not propagate or modify a covered work except as expressly provided under this License. Any attempt otherwise to propagate or modify it is void, and will automatically terminate your rights under this License (including any patent licenses granted under the third paragraph of section 11).

However, if you cease all violation of this License, then your license from a particular copyright holder is reinstated (a) provisionally, unless and until the copyright holder explicitly and finally terminates your license, and (b) permanently, if the copyright holder fails to notify you of the violation by some reasonable means prior to 60 days after the cessation.

Moreover, your license from a particular copyright holder is reinstated permanently if the copyright holder notifies you of the violation by some reasonable means, this is the first time you have received notice of violation of this License (for any work) from that copyright holder, and you cure the violation prior to 30 days after your receipt of the notice.

Termination of your rights under this section does not terminate the licenses of parties who have received copies or rights from you under this License. If your rights have been terminated and not permanently reinstated, you do not qualify to receive new licenses for the same material under section 10.

9. Acceptance Not Required for Having Copies.

You are not required to accept this License in order to receive or run a copy of the Program. Ancillary propagation of a covered work occurring solely as a consequence of using peer-to-peer transmission to receive a copy likewise does not require acceptance. However, nothing other than this License grants you permission to propagate or modify any covered work. These actions infringe copyright if you do not accept this License. Therefore, by modifying or propagating a covered work, you indicate your acceptance of this License to do so.

10. Automatic Licensing of Downstream Recipients.

Each time you convey a covered work, the recipient automatically receives a license from the original licensors, to run, modify and propagate that work, subject to this License. You are not responsible for enforcing compliance by third parties with this License.

An “entity transaction” is a transaction transferring control of an organization, or substantially all assets of one, or subdividing an organization, or merging organizations. If propagation of a covered work results from an entity transaction, each party to that transaction who receives a copy of the work also receives whatever licenses to the work the party’s predecessor in interest had or could give under the previous paragraph, plus a right to possession of the Corresponding Source of the work from the predecessor in interest, if the predecessor has it or can get it with reasonable efforts.

You may not impose any further restrictions on the exercise of the rights granted or affirmed under this License. For example, you may not impose a license fee, royalty, or other charge for exercise of rights granted under this License, and you may not initiate litigation (including a cross-claim or counterclaim in a lawsuit) alleging that any patent claim is infringed by making, using, selling, offering for sale, or importing the Program or any portion of it.

11. Patents.

A “contributor” is a copyright holder who authorizes use under this License of the Program or a work on which the Program is based. The work thus licensed is called the contributor’s “contributor version”.

A contributor’s “essential patent claims” are all patent claims owned or controlled by the contributor, whether already acquired or hereafter acquired, that would be infringed by some manner, permitted by this License, of making, using, or selling its contributor version, but do not include claims that would be infringed only as a consequence of further modification of the contributor version. For purposes of this definition, “control” includes the right to grant patent sublicenses in a manner consistent with the requirements of this License.

Each contributor grants you a non-exclusive, worldwide, royalty-free patent license under the contributor’s essential patent claims, to make, use, sell, offer for sale, import and otherwise run, modify and propagate the contents of its contributor version.

In the following three paragraphs, a “patent license” is any express agreement or commitment, however denominated, not to enforce a patent (such as an express permission to practice a patent or covenant not to sue for patent infringement). To “grant” such a patent license to a party means to make such an agreement or commitment not to enforce a patent against the party.

If you convey a covered work, knowingly relying on a patent license, and the Corresponding Source of the work is not available for anyone to copy, free of charge and under the terms of this License, through a publicly available network server or other readily accessible means, then you must either (1) cause the Corresponding Source to be so available, or (2) arrange to deprive yourself of the benefit of the patent license for this particular work, or (3) arrange, in a manner consistent with the requirements of this License, to extend the patent license to downstream recipients. “Knowingly relying” means you have actual knowledge that, but for the patent license, your conveying the covered work in a country, or your recipient’s use of the covered work in a country, would infringe one or more identifiable patents in that country that you have reason to believe are valid.

If, pursuant to or in connection with a single transaction or arrangement, you convey, or propagate by procuring conveyance of, a covered work, and grant a patent license to some of the parties receiving the covered work authorizing them to use, propagate, modify or convey a specific copy of the covered work, then the patent license you grant is automatically extended to all recipients of the covered work and works based on it.

A patent license is “discriminatory” if it does not include within the scope of its coverage, prohibits the exercise of, or is conditioned on the non-exercise of one or more of the rights that are specifically granted under this License. You may not convey a covered work if you are a party to an arrangement with a third party that is in the business of distributing software, under which you make payment to the third party based on the extent of your activity of conveying the work, and under which the third party grants, to any of the parties who would receive the covered work from you, a discriminatory patent license (a) in connection with copies of the covered work conveyed by you (or copies made from those copies), or (b) primarily for and in connection with specific products or compilations that contain the covered work, unless you entered into that arrangement, or that patent license was granted, prior to 28 March 2007.

Nothing in this License shall be construed as excluding or limiting any implied license or other defenses to infringement that may otherwise be available to you under applicable patent law.

12. No Surrender of Others’ Freedom.

If conditions are imposed on you (whether by court order, agreement or otherwise) that contradict the conditions of this License, they do not excuse you from the conditions of this License. If you cannot convey a covered work so as to satisfy simultaneously your obligations under this License and any other pertinent obligations, then as a consequence you may not convey it at all. For example, if you agree to terms that obligate you to collect a royalty for further conveying from those to whom you convey the Program, the only way you could satisfy both those terms and this License would be to refrain entirely from conveying the Program.

13. Use with the GNU Affero General Public License.

Notwithstanding any other provision of this License, you have permission to link or combine any covered work with a work licensed under version 3 of the GNU Affero General Public License into a single combined work, and to convey the resulting work. The terms of this License will continue to apply to the part which is the covered work, but the special requirements of the GNU Affero General Public License, section 13, concerning interaction through a network will apply to the combination as such.

14. Revised Versions of this License.

The Free Software Foundation may publish revised and/or new versions of the GNU General Public License from time to time. Such new versions will be similar in spirit to the present version, but may differ in detail to address new problems or concerns.

Each version is given a distinguishing version number. If the Program specifies that a certain numbered version of the GNU General Public License (“or any later version”) applies to it, you have the option of following the terms and conditions either of that numbered version or of any later version published by the Free Software Foundation. If the Program does not specify a version number of the GNU General Public License, you may choose any version ever published by the Free Software Foundation.

If the Program specifies that a proxy can decide which future versions of the GNU General Public License can be used, that proxy’s public statement of acceptance of a version permanently authorizes you to choose that version for the Program.

Later license versions may give you additional or different permissions. However, no additional obligations are imposed on any author or copyright holder as a result of your choosing to follow a later version.

15. Disclaimer of Warranty.

THERE IS NO WARRANTY FOR THE PROGRAM, TO THE EXTENT PERMITTED BY APPLICABLE LAW. EXCEPT WHEN OTHERWISE STATED IN WRITING THE COPYRIGHT HOLDERS AND/OR OTHER PARTIES PROVIDE THE PROGRAM “AS IS” WITHOUT WARRANTY OF ANY KIND, EITHER EXPRESSED OR IMPLIED, INCLUDING, BUT NOT LIMITED TO, THE IMPLIED WARRANTIES OF MERCHANTABILITY AND FITNESS FOR A PARTICULAR PURPOSE. THE ENTIRE RISK AS TO THE QUALITY AND PERFORMANCE OF THE PROGRAM IS WITH YOU. SHOULD THE PROGRAM PROVE DEFECTIVE, YOU ASSUME THE COST OF ALL NECESSARY SERVICING, REPAIR OR CORRECTION.

16. Limitation of Liability.

IN NO EVENT UNLESS REQUIRED BY APPLICABLE LAW OR AGREED TO IN WRITING WILL ANY COPYRIGHT HOLDER, OR ANY OTHER PARTY WHO MODIFIES AND/OR CONVEYS THE PROGRAM AS PERMITTED ABOVE, BE LIABLE TO YOU FOR DAMAGES, INCLUDING ANY GENERAL, SPECIAL, INCIDENTAL OR CONSEQUENTIAL DAMAGES ARISING OUT OF THE USE OR INABILITY TO USE THE PROGRAM (INCLUDING BUT NOT LIMITED TO LOSS OF DATA OR DATA BEING RENDERED INACCURATE OR LOSSES SUSTAINED BY YOU OR THIRD PARTIES OR A FAILURE OF THE PROGRAM TO OPERATE WITH ANY OTHER PROGRAMS), EVEN IF SUCH HOLDER OR OTHER PARTY HAS BEEN ADVISED OF THE POSSIBILITY OF SUCH DAMAGES.

17. Interpretation of Sections 15 and 16.

If the disclaimer of warranty and limitation of liability provided above cannot be given local legal effect according to their terms, reviewing courts shall apply local law that most closely approximates an absolute waiver of all civil liability in connection with the Program, unless a warranty or assumption of liability accompanies a copy of the Program in return for a fee.

END OF TERMS AND CONDITIONS

How to Apply These Terms to Your New Programs

If you develop a new program, and you want it to be of the greatest possible use to the public, the best way to achieve this is to make it free software which everyone can redistribute and change under these terms.

To do so, attach the following notices to the program. It is safest to attach them to the start of each source file to most effectively state the exclusion of warranty; and each file should have at least the "copyright" line and a pointer to where the full notice is found.

```
<one line to give the program's name and a brief idea of what it does.>
Copyright © <year> <name of author>
```

This program is free software: you can redistribute it and/or modify it under the terms of the GNU General Public License as published by the Free Software Foundation, either version 3 of the License, or (at your option) any later version.

This program is distributed in the hope that it will be useful, but WITHOUT ANY WARRANTY; without even the implied warranty of MERCHANTABILITY or FITNESS FOR A PARTICULAR PURPOSE. See the GNU General Public License for more details.

You should have received a copy of the GNU General Public License along with this program. If not, see <http://www.gnu.org/licenses/>.

Also add information on how to contact you by electronic and paper mail.

If the program does terminal interaction, make it output a short notice like this when it starts in an interactive mode:

```
<program> Copyright © <year> <name of author>
```

This program comes with ABSOLUTELY NO WARRANTY; for details type 'show w'.

This is free software, and you are welcome to redistribute it under certain conditions; type 'show c' for details.

The hypothetical commands 'show w' and 'show c' should show the appropriate parts of the General Public License. Of course, your program's commands might be different; for a GUI interface, you would use an "about box".

You should also get your employer (if you work as a programmer) or school, if any, to sign a "copyright disclaimer" for the program, if necessary.

For more information on this, and how to apply and follow the GNU GPL, see

<http://www.gnu.org/licenses/>.

The GNU General Public License does not permit incorporating your program into proprietary programs. If your program is a subroutine library, you may consider it more useful to permit linking proprietary applications with the library. If this is what you want to do, use the GNU Lesser General Public License instead of this License. But first, please read

<http://www.gnu.org/philosophy/why-not-lgpl.html>.

GCC RUNTIME LIBRARY EXCEPTION

Version 3.1, 31 March 2009

Copyright © 2009 Free Software Foundation, Inc. <http://fsf.org/>

Everyone is permitted to copy and distribute verbatim copies of this license document, but changing it is not allowed.

This GCC Runtime Library Exception ("Exception") is an additional permission under section 7 of the GNU General Public License, version 3 ("GPLv3"). It applies to a given file (the "Runtime Library") that bears a notice placed by the copyright holder of the file stating that the file is governed by GPLv3 along with this Exception.

When you use GCC to compile a program, GCC may combine portions of certain GCC header files and runtime libraries with the compiled program. The purpose of this Exception is to allow compilation of non-GPL (including proprietary) programs to use, in this way, the header files and runtime libraries covered by this Exception.

0. Definitions.

A file is an "Independent Module" if it either requires the Runtime Library for execution after a Compilation Process, or makes use of an interface provided by the Runtime Library, but is not otherwise based on the Runtime Library.

"GCC" means a version of the GNU Compiler Collection, with or without modifications, governed by version 3 (or a specified later version) of the GNU General Public License (GPL) with the option of using any subsequent versions published by the FSF.

"GPL-compatible Software" is software whose conditions of propagation, modification and use would permit combination with GCC in accord with the license of GCC.

"Target Code" refers to output from any compiler for a real or virtual target processor architecture, in executable form or suitable for input to an assembler, loader, linker and/or execution phase.

Notwithstanding that, Target Code does not include data in any format that is used as a compiler intermediate representation, or used for producing a compiler intermediate representation.

The "Compilation Process" transforms code entirely represented in non-intermediate languages designed for human-written code, and/or in Java Virtual Machine byte code, into Target Code. Thus, for example, use of source code generators and preprocessors need not be considered part of the Compilation Process, since the Compilation Process can be understood as starting with the output of the generators or preprocessors.

A Compilation Process is "Eligible" if it is done using GCC, alone or with other GPL-compatible software, or if it is done without using any work based on GCC. For example, using non-GPL-compatible Software to optimize any GCC intermediate representations would not qualify as an Eligible Compilation Process.

1. Grant of Additional Permission.

You have permission to propagate a work of Target Code formed by combining the Runtime Library with Independent Modules, even if such propagation would otherwise violate the terms of GPLv3, provided that all Target Code was generated by Eligible Compilation Processes.

You may then convey such a combination under terms of your choice, consistent with the licensing of the Independent Modules.

2. No Weakening of GCC Copyleft.

The availability of this Exception does not imply any general presumption that third-party software is unaffected by the copyleft requirements of the license of GCC.

■ About glibc, libmtp, libusb, libusb-compat, DirectFB, SaWMan, Qt

GNU LESSER GENERAL PUBLIC LICENSE

Version 2.1, February 1999

Copyright © 1991, 1999 Free Software Foundation, Inc.
59 Temple Place, Suite 330, Boston, MA 02111-1307 USA

Everyone is permitted to copy and distribute verbatim copies of this license document, but changing it is not allowed.

[This is the first released version of the Lesser GPL. It also counts as the successor of the GNU Library Public License, version 2, hence the version number 2.1.]

Preamble

The licenses for most software are designed to take away your freedom to share and change it. By contrast, the GNU General Public Licenses are intended to guarantee your freedom to share and change free software—to make sure the software is free for all its users.

This license, the Lesser General Public License, applies to some specially designated software packages—typically libraries—of the Free Software Foundation and other authors who decide to use it. You can use it too, but we suggest you first think carefully about whether this license or the ordinary General Public License is the better strategy to use in any particular case, based on the explanations below.

When we speak of free software, we are referring to freedom of use, not price. Our General Public Licenses are designed to make sure that you have the freedom to distribute copies of free software (and charge for this service if you wish); that you receive source code or can get it if you want it; that you can change the software and use pieces of it in new free programs; and that you are informed that you can do these things.

To protect your rights, we need to make restrictions that forbid distributors to deny you these rights or to ask you to surrender these rights. These restrictions translate to certain responsibilities for you if you distribute copies of the library or if you modify it.

For example, if you distribute copies of the library, whether gratis or for a fee, you must give the recipients all the rights that we gave you. You must make sure that they, too, receive or can get the source code. If you link other code with the library, you must provide complete object files to the recipients, so that they can relink them with the library after making changes to the library and recompiling it. And you must show them these terms so they know their rights.

We protect your rights with a two-step method: (1) we copyright the library, and (2) we offer you this license, which gives you legal permission to copy, distribute and/or modify the library.

To protect each distributor, we want to make it very clear that there is no warranty for the free library. Also, if the library is modified by someone else and passed on, the recipients should know that what they have is not the original version, so that the original author's reputation will not be affected by problems that might be introduced by others.

Finally, software patents pose a constant threat to the existence of any free program. We wish to make sure that a company cannot effectively restrict the users of a free program by obtaining a restrictive license from a patent holder. Therefore, we insist that any patent license obtained for a version of the library must be consistent with the full freedom of use specified in this license.

Most GNU software, including some libraries, is covered by the ordinary GNU General Public License. This license, the GNU Lesser General Public License, applies to certain designated libraries, and is quite different from the ordinary General Public License. We use this license for certain libraries in order to permit linking those libraries into non-free programs.

When a program is linked with a library, whether statically or using a shared library, the combination of the two is legally speaking a combined work, a derivative of the original library. The ordinary General Public License therefore permits such linking only if the entire combination fits its criteria of freedom. The Lesser General Public License permits more lax criteria for linking other code with the library.

We call this license the "Lesser" General Public License because it does Less to protect the user's freedom than the ordinary General Public License. It also provides other free software developers Less of an advantage over competing non-free programs. These disadvantages are the reason we use the ordinary General Public License for many libraries. However, the Lesser License provides advantages in certain special circumstances.

For example, on rare occasions, there may be a special need to encourage the widest possible use of a certain library, so that it becomes a de-facto standard. To achieve this, non-free programs must be allowed to use the library. A more frequent case is that a free library does the same job as widely used non-free libraries. In this case, there is little to gain by limiting the free library to free software only, so we use the Lesser General Public License.

In other cases, permission to use a particular library in non-free programs enables a greater number of people to use a large body of free software. For example, permission to use the GNU C Library in non-free programs enables many more people to use the whole GNU operating system, as well as its variant, the GNU/Linux operating system.

Although the Lesser General Public License is Less protective of the users' freedom, it does ensure that the user of a program that is linked with the Library has the freedom and the wherewithal to run that program using a modified version of the Library.

The precise terms and conditions for copying, distribution and modification follow. Pay close attention to the difference between a "work based on the library" and a "work that uses the library". The former contains code derived from the library, whereas the latter must be combined with the library in order to run.

GNU LESSER GENERAL PUBLIC LICENSE
TERMS AND CONDITIONS FOR COPYING, DISTRIBUTION AND
MODIFICATION

0. This License Agreement applies to any software library or other program which contains a notice placed by the copyright holder or other authorized party saying it may be distributed under the terms of this Lesser General Public License (also called "this License"). Each licensee is addressed as "you".

A "library" means a collection of software functions and/or data prepared so as to be conveniently linked with application programs (which use some of those functions and data) to form executables.

The "Library", below, refers to any such software library or work which has been distributed under these terms. A "work based on the Library" means either the Library or any derivative work under copyright law: that is to say, a work containing the Library or a portion of it, either verbatim or with modifications and/or translated straightforwardly into another language. (Hereinafter, translation is included without limitation in the term "modification".)

"Source code" for a work means the preferred form of the work for making modifications to it. For a library, complete source code means all the source code for all modules it contains, plus any associated interface definition files, plus the scripts used to control compilation and installation of the library.

Activities other than copying, distribution and modification are not covered by this License; they are outside its scope. The act of running a program using the Library is not restricted, and output from such a program is covered only if its contents constitute a work based on the Library (independent of the use of the Library in a tool for writing it). Whether that is true depends on what the Library does and what the program that uses the Library does.

1. You may copy and distribute verbatim copies of the Library's complete source code as you receive it, in any medium, provided that you conspicuously and appropriately publish on each copy an appropriate copyright notice and disclaimer of warranty; keep intact all the notices that refer to this License and to the absence of any warranty; and distribute a copy of this License along with the Library.

You may charge a fee for the physical act of transferring a copy, and you may at your option offer warranty protection in exchange for a fee.

2. You may modify your copy or copies of the Library or any portion of it, thus forming a work based on the Library, and copy and distribute such modifications or work under the terms of Section 1 above, provided that you also meet all of these conditions:

- a) The modified work must itself be a software library.
- b) You must cause the files modified to carry prominent notices stating that you changed the files and the date of any change.
- c) You must cause the whole of the work to be licensed at no charge to all third parties under the terms of this License.
- d) If a facility in the modified Library refers to a function or a table of data to be supplied by an application program that uses the facility, other than as an argument passed when the facility is invoked, then you must make a good faith effort to ensure that, in the event an application does not supply such function or table, the facility still operates, and performs whatever part of its purpose remains meaningful.

(For example, a function in a library to compute square roots has a purpose that is entirely well-defined independent of the application. Therefore, Subsection 2d requires that any application-supplied function or table used by this function must be optional: if the application does not supply it, the square root function must still compute square roots.)

These requirements apply to the modified work as a whole. If identifiable sections of that work are not derived from the Library, and can be reasonably considered independent and separate works in themselves, then this License, and its terms, do not apply to those sections when you distribute them as separate works. But when you distribute the same sections as part of a whole which is a work based on the Library, the distribution of the whole must be on the terms of this License, whose permissions for other licensees extend to the entire whole, and thus to each and every part regardless of who wrote it.

Thus, it is not the intent of this section to claim rights or contest your rights to work written entirely by you; rather, the intent is to exercise the right to control the distribution of derivative or collective works based on the Library.

In addition, mere aggregation of another work not based on the Library with the Library (or with a work based on the Library) on a volume of a storage or distribution medium does not bring the other work under the scope of this License.

3. You may opt to apply the terms of the ordinary GNU General Public License instead of this License to a given copy of the Library. To do this, you must alter all the notices that refer to this License, so that they refer to the ordinary GNU General Public License, version 2, instead of to this License. (If a newer version than version 2 of the ordinary GNU General Public License has appeared, then you can specify that version instead if you wish.) Do not make any other change in these notices.

Once this change is made in a given copy, it is irreversible for that copy, so the ordinary GNU General Public License applies to all subsequent copies and derivative works made from that copy.

This option is useful when you wish to copy part of the code of the Library into a program that is not a library.

4. You may copy and distribute the Library (or a portion or derivative of it, under Section 2) in object code or executable form under the terms of Sections 1 and 2 above provided that you accompany it with the complete corresponding machine-readable source code, which must be distributed under the terms of Sections 1 and 2 above on a medium customarily used for software interchange.

If distribution of object code is made by offering access to copy from a designated place, then offering equivalent access to copy the source code from the same place satisfies the requirement to distribute the source code, even though third parties are not compelled to copy the source along with the object code.

5. A program that contains no derivative of any portion of the Library, but is designed to work with the Library by being compiled or linked with it, is called a "work that uses the Library". Such a work, in isolation, is not a derivative work of the Library, and therefore falls outside the scope of this License.

However, linking a "work that uses the Library" with the Library creates an executable that is a derivative of the Library (because it contains portions of the Library), rather than a "work that uses the library". The executable is therefore covered by this License. Section 6 states terms for distribution of such executables.

When a "work that uses the Library" uses material from a header file that is part of the Library, the object code for the work may be a derivative work of the Library even though the source code is not. Whether this is true is especially significant if the work can be linked without the Library, or if the work is itself a library. The threshold for this to be true is not precisely defined by law.

If such an object file uses only numerical parameters, data structure layouts and accessors, and small macros and small inline functions (ten lines or less in length), then the use of the object file is unrestricted, regardless of whether it is legally a derivative work. (Executables containing this object code plus portions of the Library will still fall under Section 6.)

Otherwise, if the work is a derivative of the Library, you may distribute the object code for the work under the terms of Section 6. Any executables containing that work also fall under Section 6, whether or not they are linked directly with the Library itself.

6. As an exception to the Sections above, you may also combine or link a "work that uses the Library" with the Library to produce a work containing portions of the Library, and distribute that work under terms of your choice, provided that the terms permit modification of the work for the customer's own use and reverse engineering for debugging such modifications.

You must give prominent notice with each copy of the work that the Library is used in it and that the Library and its use are covered by this License. You must supply a copy of this License. If the work during execution displays copyright notices, you must include the copyright notice for the Library among them, as well as a reference directing the user to the copy of this License. Also, you must do one of these things:

- a) Accompany the work with the complete corresponding machine-readable source code for the Library including whatever changes were used in the work (which must be distributed under Sections 1 and 2 above); and, if the work is an executable linked with the Library, with the complete machine-readable "work that uses the Library", as object code and/or source code, so that the user can modify the Library and then relink to produce a modified executable containing the modified Library. (It is understood that the user who changes the contents of definitions files in the Library will not necessarily be able to recompile the application to use the modified definitions.)
- b) Use a suitable shared library mechanism for linking with the Library. A suitable mechanism is one that (1) uses at run time a copy of the library already present on the user's computer system, rather than copying library functions into the executable, and (2) will operate properly with a modified version of the library, if the user installs one, as long as the modified version is interface-compatible with the version that the work was made with.
- c) Accompany the work with a written offer, valid for at least three years, to give the same user the materials specified in Subsection 6a, above, for a charge no more than the cost of performing this distribution.
- d) If distribution of the work is made by offering access to copy from a designated place, offer equivalent access to copy the above specified materials from the same place.
- e) Verify that the user has already received a copy of these materials or that you have already sent this user a copy.

For an executable, the required form of the "work that uses the Library" must include any data and utility programs needed for reproducing the executable from it. However, as a special exception, the materials to be distributed need not include anything that is normally distributed (in either source or binary form) with the major components (compiler, kernel, and so on) of the operating system on which the executable runs, unless that component itself accompanies the executable.

It may happen that this requirement contradicts the license restrictions of other proprietary libraries that do not normally accompany the operating system. Such a contradiction means you cannot use both them and the Library together in an executable that you distribute.

7. You may place library facilities that are a work based on the Library side-by-side in a single library together with other library facilities not covered by this License, and distribute such a combined library, provided that the separate distribution of the work based on the Library and of the other library facilities is otherwise permitted, and provided that you do these two things:

- a) Accompany the combined library with a copy of the same work based on the Library, uncombined with any other library facilities. This must be distributed under the terms of the Sections above.
- b) Give prominent notice with the combined library of the fact that part of it is a work based on the Library, and explaining where to find the accompanying uncombined form of the same work.

8. You may not copy, modify, sublicense, link with, or distribute the Library except as expressly provided under this License. Any attempt otherwise to copy, modify, sublicense, link with, or distribute the Library is void, and will automatically terminate your rights under this License. However, parties who have received copies, or rights, from you under this License will not have their licenses terminated so long as such parties remain in full compliance.

9. You are not required to accept this License, since you have not signed it. However, nothing else grants you permission to modify or distribute the Library or its derivative works. These actions are prohibited by law if you do not accept this License. Therefore, by modifying or distributing the Library (or any work based on the Library), you indicate your acceptance of this License to do so, and all its terms and conditions for copying, distributing or modifying the Library or works based on it.

10. Each time you redistribute the Library (or any work based on the Library), the recipient automatically receives a license from the original licensor to copy, distribute, link with or modify the Library subject to these terms and conditions. You may not impose any further restrictions on the recipients' exercise of the rights granted herein. You are not responsible for enforcing compliance by third parties with this License.
11. If, as a consequence of a court judgment or allegation of patent infringement or for any other reason (not limited to patent issues), conditions are imposed on you (whether by court order, agreement or otherwise) that contradict the conditions of this License, they do not excuse you from the conditions of this License. If you cannot distribute so as to satisfy simultaneously your obligations under this License and any other pertinent obligations, then as a consequence you may not distribute the Library at all. For example, if a patent license would not permit royalty-free redistribution of the Library by all those who receive copies directly or indirectly through you, then the only way you could satisfy both it and this License would be to refrain entirely from distribution of the Library.

If any portion of this section is held invalid or unenforceable under any particular circumstance, the balance of the section is intended to apply, and the section as a whole is intended to apply in other circumstances.

It is not the purpose of this section to induce you to infringe any patents or other property right claims or to contest validity of any such claims; this section has the sole purpose of protecting the integrity of the free software distribution system which is implemented by public license practices. Many people have made generous contributions to the wide range of software distributed through that system in reliance on consistent application of that system; it is up to the author/donor to decide if he or she is willing to distribute software through any other system and a licensee cannot impose that choice.

This section is intended to make thoroughly clear what is believed to be a consequence of the rest of this License.

12. If the distribution and/or use of the Library is restricted in certain countries either by patents or by copyrighted interfaces, the original copyright holder who places the Library under this License may add an explicit geographical distribution limitation excluding those countries, so that distribution is permitted only in or among countries not thus excluded. In such case, this License incorporates the limitation as if written in the body of this License.
13. The Free Software Foundation may publish revised and/or new versions of the Lesser General Public License from time to time. Such new versions will be similar in spirit to the present version, but may differ in detail to address new problems or concerns.

Each version is given a distinguishing version number. If the Library specifies a version number of this License which applies to it and "any later version", you have the option of following the terms and conditions either of that version or of any later version published by the Free Software Foundation. If the Library does not specify a license version number, you may choose any version ever published by the Free Software Foundation.

14. If you wish to incorporate parts of the Library into other free programs whose distribution conditions are incompatible with these, write to the author to ask for permission. For software which is copyrighted by the Free Software Foundation, write to the Free Software Foundation; we sometimes make exceptions for this. Our decision will be guided by the two goals of preserving the free status of all derivatives of our free software and of promoting the sharing and reuse of software generally.

NO WARRANTY

15. BECAUSE THE LIBRARY IS LICENSED FREE OF CHARGE, THERE IS NO WARRANTY FOR THE LIBRARY. TO THE EXTENT PERMITTED BY APPLICABLE LAW. EXCEPT WHEN OTHERWISE STATED IN WRITING THE COPYRIGHT HOLDERS AND/OR OTHER PARTIES PROVIDE THE LIBRARY "AS IS" WITHOUT WARRANTY OF ANY KIND, EITHER EXPRESSED OR IMPLIED, INCLUDING, BUT NOT LIMITED TO, THE IMPLIED WARRANTIES OF MERCHANTABILITY AND FITNESS FOR A PARTICULAR PURPOSE. THE ENTIRE RISK AS TO THE QUALITY AND PERFORMANCE OF THE LIBRARY IS WITH YOU. SHOULD THE LIBRARY PROVE DEFECTIVE, YOU ASSUME THE COST OF ALL NECESSARY SERVICING, REPAIR OR CORRECTION.
16. IN NO EVENT UNLESS REQUIRED BY APPLICABLE LAW OR AGREED TO IN WRITING WILL ANY COPYRIGHT HOLDER, OR ANY OTHER PARTY WHO MAY MODIFY AND/OR REDISTRIBUTE THE LIBRARY AS PERMITTED ABOVE, BE LIABLE TO YOU FOR DAMAGES, INCLUDING ANY GENERAL, SPECIAL, INCIDENTAL OR CONSEQUENTIAL DAMAGES ARISING OUT OF THE USE OR INABILITY TO USE THE LIBRARY (INCLUDING BUT NOT LIMITED TO LOSS OF DATA OR DATA BEING RENDERED INACCURATE OR LOSSES SUSTAINED BY YOU OR THIRD PARTIES OR A FAILURE OF THE LIBRARY TO OPERATE WITH ANY OTHER SOFTWARE), EVEN IF SUCH HOLDER OR OTHER PARTY HAS BEEN ADVISED OF THE POSSIBILITY OF SUCH DAMAGES.

END OF TERMS AND CONDITIONS

How to Apply These Terms to Your New Libraries

If you develop a new library, and you want it to be of the greatest possible use to the public, we recommend making it free software that everyone can redistribute and change. You can do so by permitting redistribution under these terms (or, alternatively, under the terms of the ordinary General Public License).

To apply these terms, attach the following notices to the library. It is safest to attach them to the start of each source file to most effectively convey the exclusion of warranty; and each file should have at least the "copyright" line and a pointer to where the full notice is found.

```
<one line to give the library's name and a brief idea of what it does.> Copyright ©
<year> <name of author>
```

This library is free software; you can redistribute it and/or modify it under the terms of the GNU Lesser General Public License as published by the Free Software Foundation; either version 2 of the License, or (at your option) any later version.

This library is distributed in the hope that it will be useful, but WITHOUT ANY WARRANTY; without even the implied warranty of MERCHANTABILITY or FITNESS FOR A PARTICULAR PURPOSE. See the GNU Lesser General Public License for more details.

You should have received a copy of the GNU Lesser General Public License along with this library; if not, write to the Free Software Foundation, Inc., 59 Temple Place, Suite 330, Boston, MA 02111-1307 USA

Also add information on how to contact you by electronic and paper mail.

You should also get your employer (if you work as a programmer) or your school, if any, to sign a "copyright disclaimer" for the library, if necessary. Here is a sample; alter the names:

```
Yoodyne, Inc., hereby disclaims all copyright interest in the library 'Frob' (a
library for tweaking knobs) written by James Random Hacker.
```

```
<signature of Ty Coon>, 1 April 1990 Ty Coon, President of Vice
```

That's all there is to it!

■ About Live555, procps (ps, top), libavformat, libavutil, libavcodec, zziplib

GNU LIBRARY GENERAL PUBLIC LICENSE

Version 2, June 1991

Copyright (C) 1991 Free Software Foundation, Inc.

51 Franklin St, Fifth Floor, Boston, MA 02110-1301, USA

Everyone is permitted to copy and distribute verbatim copies of this license document, but changing it is not allowed.

[This is the first released version of the library GPL. It is numbered 2 because it goes with version 2 of the ordinary GPL.]

Preamble

The licenses for most software are designed to take away your freedom to share and change it. By contrast, the GNU General Public Licenses are intended to guarantee your freedom to share and change free software--to make sure the software is free for all its users.

This license, the Library General Public License, applies to some specially designated Free Software Foundation software, and to any other libraries whose authors decide to use it. You can use it for your libraries, too.

When we speak of free software, we are referring to freedom, not price. Our General Public Licenses are designed to make sure that you have the freedom to distribute copies of free software (and charge for this service if you wish), that you receive source code or can get it if you want it, that you can change the software or use pieces of it in new free programs; and that you know you can do these things.

To protect your rights, we need to make restrictions that forbid anyone to deny you these rights or to ask you to surrender the rights. These restrictions translate to certain responsibilities for you if you distribute copies of the library, or if you modify it.

For example, if you distribute copies of the library, whether gratis or for a fee, you must give the recipients all the rights that we gave you. You must make sure that they, too, receive or can get the source code. If you link a program with the library, you must provide complete object files to the recipients so that they can relink them with the library, after making changes to the library and recompiling it. And you must show them these terms so they know their rights.

Our method of protecting your rights has two steps: (1) copyright the library, and (2) offer you this license which gives you legal permission to copy, distribute and/or modify the library.

Also, for each distributor's protection, we want to make certain that everyone understands that there is no warranty for this free library. If the library is modified by someone else and passed on, we want its recipients to know that what they have is not the original version, so that any problems introduced by others will not reflect on the original authors' reputations.

Finally, any free program is threatened constantly by software patents. We wish to avoid the danger that companies distributing free software will individually obtain patent licenses, thus in effect transforming the program into proprietary software. To prevent this, we have made it clear that any patent must be licensed for everyone's free use or not licensed at all.

Most GNU software, including some libraries, is covered by the ordinary GNU General Public License, which was designed for utility programs. This license, the GNU Library General Public License, applies to certain designated libraries. This license is quite different from the ordinary one; be sure to read it in full, and don't assume that anything in it is the same as in the ordinary license.

The reason we have a separate public license for some libraries is that they blur the distinction we usually make between modifying or adding to a program and simply using it. Linking a program with a library, without changing the library, is in some sense simply using the library, and is analogous to running a utility program or application program. However, in a textual and legal sense, the linked executable is a combined work, a derivative of the original library, and the ordinary General Public License treats it as such.

Because of this blurred distinction, using the ordinary General Public License for libraries did not effectively promote software sharing, because most developers did not use the libraries. We concluded that weaker conditions might promote sharing better.

However, unrestricted linking of non-free programs would deprive the users of those programs of all benefit from the free status of the libraries themselves. This Library General Public License is intended to permit developers of non-free programs to use free libraries, while preserving your freedom as a user of such programs to change the free libraries that are incorporated in them. (We have not seen how to achieve this as regards changes in header files, but we have achieved it as regards changes in the actual functions of the Library.) The hope is that this will lead to faster development of free libraries.

The precise terms and conditions for copying, distribution and modification follow. Pay close attention to the difference between a “work based on the library” and a “work that uses the library”. The former contains code derived from the library, while the latter only works together with the library.

Note that it is possible for a library to be covered by the ordinary General Public License rather than by this special one.

GNU LIBRARY GENERAL PUBLIC LICENSE

TERMS AND CONDITIONS FOR COPYING, DISTRIBUTION AND MODIFICATION

0. This License Agreement applies to any software library which contains a notice placed by the copyright holder or other authorized party saying it may be distributed under the terms of this Library General Public License (also called “this License”). Each licensee is addressed as “you”.

A “library” means a collection of software functions and/or data prepared so as to be conveniently linked with application programs (which use some of those functions and data) to form executables.

The “Library”, below, refers to any such software library or work which has been distributed under these terms. A “work based on the Library” means either the Library or any derivative work under copyright law: that is to say, a work containing the Library or a portion of it, either verbatim or with modifications and/or translated straightforwardly into another language. (Hereinafter, translation is included without limitation in the term “modification”).

“Source code” for a work means the preferred form of the work for making modifications to it. For a library, complete source code means all the source code for all modules it contains, plus any associated interface definition files, plus the scripts used to control compilation and installation of the library.

Activities other than copying, distribution and modification are not covered by this License; they are outside its scope. The act of running a program using the Library is not restricted, and output from such a program is covered only if its contents constitute a work based on the Library (independent of the use of the Library in a tool for writing it). Whether that is true depends on what the Library does and what the program that uses the Library does.

1. You may copy and distribute verbatim copies of the Library’s complete source code as you receive it, in any medium, provided that you conspicuously and appropriately publish on each copy an appropriate copyright notice and disclaimer of warranty; keep intact all the notices that refer to this License and to the absence of any warranty; and distribute a copy of this License along with the Library.

You may charge a fee for the physical act of transferring a copy, and you may at your option offer warranty protection in exchange for a fee.

2. You may modify your copy or copies of the Library or any portion of it, thus forming a work based on the Library, and copy and distribute such modifications or work under the terms of Section 1 above, provided that you also meet all of these conditions:

- The modified work must itself be a software library.
- You must cause the files modified to carry prominent notices stating that you changed the files and the date of any change.
- You must cause the whole of the work to be licensed at no charge to all third parties under the terms of this License.
- If a facility in the modified Library refers to a function or a table of data to be supplied by an application program that uses the facility, other than as an argument passed when the facility is invoked, then you must make a good faith effort to ensure that, in the event an application does not supply such function or table, the facility still operates, and performs whatever part of its purpose remains meaningful.

(For example, a function in a library to compute square roots has a purpose that is entirely well-defined independent of the application. Therefore, Subsection 2d requires that any application-supplied function or table used by this function must be optional: if the application does not supply it, the square root function must still compute square roots.)

These requirements apply to the modified work as a whole. If identifiable sections of that work are not derived from the Library, and can be reasonably considered independent and separate works in themselves, then this License, and its terms, do not apply to those sections when you distribute them as separate works. But when you distribute the same sections as part of a whole which is a work based on the Library, the distribution of the whole must be on the terms of this License, whose permissions for other licensees extend to the entire whole, and thus to each and every part regardless of who wrote it.

Thus, it is not the intent of this section to claim rights or contest your rights to work written entirely by you; rather, the intent is to exercise the right to control the distribution of derivative or collective works based on the Library.

In addition, mere aggregation of another work not based on the Library with the Library (or with a work based on the Library) on a volume of a storage or distribution medium does not bring the other work under the scope of this License.

3. You may opt to apply the terms of the ordinary GNU General Public License instead of this License to a given copy of the Library. To do this, you must alter all the notices that refer to this License, so that they refer to the ordinary GNU General Public License, version 2, instead of to this License. (If a newer version than version 2 of the ordinary GNU General Public License has appeared, then you can specify that version instead if you wish.) Do not make any other change in these notices.

Once this change is made in a given copy, it is irreversible for that copy, so the ordinary GNU General Public License applies to all subsequent copies and derivative works made from that copy.

This option is useful when you wish to copy part of the code of the Library into a program that is not a library.

4. You may copy and distribute the Library (or a portion or derivative of it, under Section 2) in object code or executable form under the terms of Sections 1 and 2 above provided that you accompany it with the complete corresponding machine-readable source code, which must be distributed under the terms of Sections 1 and 2 above on a medium customarily used for software interchange.

If distribution of object code is made by offering access to copy from a designated place, then offering equivalent access to copy the source code from the same place satisfies the requirement to distribute the source code, even though third parties are not compelled to copy the source along with the object code.

5. A program that contains no derivative of any portion of the Library, but is designed to work with the Library by being compiled or linked with it, is called a “work that uses the Library”. Such a work, in isolation, is not a derivative work of the Library, and therefore falls outside the scope of this License.

However, linking a “work that uses the Library” with the Library creates an executable that is a derivative of the Library (because it contains portions of the Library), rather than a “work that uses the library”. The executable is therefore covered by this License. Section 6 states terms for distribution of such executables.

When a “work that uses the Library” uses material from a header file that is part of the Library, the object code for the work may be a derivative work of the Library even though the source code is not. Whether this is true is especially significant if the work can be linked without the Library, or if the work is itself a library. The threshold for this to be true is not precisely defined by law.

If such an object file uses only numerical parameters, data structure layouts and accessors, and small macros and small inline functions (ten lines or less in length), then the use of the object file is unrestricted, regardless of whether it is legally a derivative work. (Executables containing this object code plus portions of the Library will still fall under Section 6.)

Otherwise, if the work is a derivative of the Library, you may distribute the object code for the work under the terms of Section 6. Any executables containing that work also fall under Section 6, whether or not they are linked directly with the Library itself.

6. As an exception to the Sections above, you may also compile or link a “work that uses the Library” with the Library to produce a work containing portions of the Library, and distribute that work under terms of your choice, provided that the terms permit modification of the work for the customer’s own use and reverse engineering for debugging such modifications.

You must give prominent notice with each copy of the work that the Library is used in it and that the Library and its use are covered by this License. You must supply a copy of this License. If the work during execution displays copyright notices, you must include the copyright notice for the Library among them, as well as a reference directing the user to the copy of this License. Also, you must do one of these things:

- Accompany the work with the complete corresponding machine-readable source code for the Library including whatever changes were used in the work (which must be distributed under Sections 1 and 2 above); and, if the work is an executable linked with the Library, with the complete machine-readable “work that uses the Library”, as object code and/or source code, so that the user can modify the Library and then relink to produce a modified executable containing the modified Library. (It is understood that the user who changes the contents of definitions files in the Library will not necessarily be able to recompile the application to use the modified definitions.)
- Accompany the work with a written offer, valid for at least three years, to give the same user the materials specified in Subsection 6a, above, for a charge no more than the cost of performing this distribution.

- If distribution of the work is made by offering access to copy from a designated place, offer equivalent access to copy the above specified materials from the same place
- Verify that the user has already received a copy of these materials or that you have already sent this user a copy.

For an executable, the required form of the “work that uses the Library” must include any data and utility programs needed for reproducing the executable from it. However, as a special exception, the source code distributed need not include anything that is normally distributed (in either source or binary form) with the major components (compiler, kernel, and so on) of the operating system on which the executable runs, unless that component itself accompanies the executable.

It may happen that this requirement contradicts the license restrictions of other proprietary libraries that do not normally accompany the operating system. Such a contradiction means you cannot use both them and the Library together in an executable that you distribute.

7. You may place library facilities that are a work based on the Library side-by-side in a single library together with other library facilities not covered by this License, and distribute such a combined library, provided that the separate distribution of the work based on the Library and of the other library facilities is otherwise permitted, and provided that you do these two things:

- Accompany the combined library with a copy of the same work based on the Library, uncombined with any other library facilities. This must be distributed under the terms of the Sections above.

- Give prominent notice with the combined library of the fact that part of it is a work based on the Library, and explaining where to find the accompanying uncombined form of the same work.

8. You may not copy, modify, sublicense, link with, or distribute the Library except as expressly provided under this License. Any attempt otherwise to copy, modify, sublicense, link with, or distribute the Library is void, and will automatically terminate your rights under this License. However, parties who have received copies, or rights, from you under this License will not have their licenses terminated so long as such parties remain in full compliance.

9. You are not required to accept this License, since you have not signed it. However, nothing else grants you permission to modify or distribute the Library or its derivative works. These actions are prohibited by law if you do not accept this License. Therefore, by modifying or distributing the Library (or any work based on the Library), you indicate your acceptance of this License to do so, and all its terms and conditions for copying, distributing or modifying the Library or works based on it.

10. Each time you redistribute the Library (or any work based on the Library), the recipient automatically receives a license from the original licensor to copy, distribute, link with or modify the Library subject to these terms and conditions. You may not impose any further restrictions on the recipients’ exercise of the rights granted herein. You are not responsible for enforcing compliance by third parties to this License.

11. If, as a consequence of a court judgment or allegation of patent infringement or for any other reason (not limited to patent issues), conditions are imposed on you (whether by court order, agreement or otherwise) that contradict the conditions of this License, they do not excuse you from the conditions of this License. If you cannot distribute so as to satisfy simultaneously your obligations under this License and any other pertinent obligations, then as a consequence you may not distribute the Library at all. For example, if a patent license would not permit royalty-free redistribution of the Library by all those who receive copies directly or indirectly through you, then the only way you could satisfy both it and this License would be to refrain entirely from distribution of the Library.

If any portion of this section is held invalid or unenforceable under any particular circumstance, the balance of the section is intended to apply, and the section as a whole is intended to apply in other circumstances.

It is not the purpose of this section to induce you to infringe any patents or other property right claims or to contest validity of any such claims; this section has the sole purpose of protecting the integrity of the free software distribution system which is implemented by public license practices. Many people have made generous contributions to the wide range of software distributed through that system in reliance on consistent application of that system; it is up to the author/donor to decide if he or she is willing to distribute software through any other system and a licensee cannot impose that choice.

This section is intended to make thoroughly clear what is believed to be a consequence of the rest of this License.

12. If the distribution and/or use of the Library is restricted in certain countries either by patents or by copyrighted interfaces, the original copyright holder who places the Library under this License may add an explicit geographical distribution limitation excluding those countries, so that distribution is permitted only in or among countries not thus excluded. In such case, this License incorporates the limitation as if written in the body of this License.

13. The Free Software Foundation may publish revised and/or new versions of the Library General Public License from time to time. Such new versions will be similar in spirit to the present version, but may differ in detail to address new problems or concerns.

Each version is given a distinguishing version number. If the Library specifies a version number of this License which applies to it and "any later version", you have the option of following the terms and conditions either of that version or of any later version published by the Free Software Foundation. If the Library does not specify a license version number, you may choose any version ever published by the Free Software Foundation.

14. If you wish to incorporate parts of the Library into other free programs whose distribution conditions are incompatible with these, write to the author to ask for permission. For software which is copyrighted by the Free Software Foundation, write to the Free Software Foundation; we sometimes make exceptions for this. Our decision will be guided by the two goals of preserving the free status of all derivatives of our free software and of promoting the sharing and reuse of software generally.

NO WARRANTY

15. BECAUSE THE LIBRARY IS LICENSED FREE OF CHARGE, THERE IS NO WARRANTY FOR THE LIBRARY, TO THE EXTENT PERMITTED BY APPLICABLE LAW. EXCEPT WHEN OTHERWISE STATED IN WRITING THE COPYRIGHT HOLDERS AND/OR OTHER PARTIES PROVIDE THE LIBRARY "AS IS" WITHOUT WARRANTY OF ANY KIND, EITHER EXPRESSED OR IMPLIED, INCLUDING, BUT NOT LIMITED TO, THE IMPLIED WARRANTIES OF MERCHANTABILITY AND FITNESS FOR A PARTICULAR PURPOSE. THE ENTIRE RISK AS TO THE QUALITY AND PERFORMANCE OF THE LIBRARY IS WITH YOU. SHOULD THE LIBRARY PROVE DEFECTIVE, YOU ASSUME THE COST OF ALL NECESSARY SERVICING, REPAIR OR CORRECTION.

16. IN NO EVENT UNLESS REQUIRED BY APPLICABLE LAW OR AGREED TO IN WRITING WILL ANY COPYRIGHT HOLDER, OR ANY OTHER PARTY WHO MAY MODIFY AND/OR REDISTRIBUTE THE LIBRARY AS PERMITTED ABOVE, BE LIABLE TO YOU FOR DAMAGES, INCLUDING ANY GENERAL, SPECIAL, INCIDENTAL OR CONSEQUENTIAL DAMAGES ARISING OUT OF THE USE OR INABILITY TO USE THE LIBRARY (INCLUDING BUT NOT LIMITED TO LOSS OF DATA OR DATA BEING RENDERED INACCURATE OR LOSSES SUSTAINED BY YOU OR THIRD PARTIES OR A FAILURE OF THE LIBRARY TO OPERATE WITH ANY OTHER SOFTWARE), EVEN IF SUCH HOLDER OR OTHER PARTY HAS BEEN ADVISED OF THE POSSIBILITY OF SUCH DAMAGES.

END OF TERMS AND CONDITIONS

How to Apply These Terms to Your New Libraries

If you develop a new library, and you want it to be of the greatest possible use to the public, we recommend making it free software that everyone can redistribute and change. You can do so by permitting redistribution under these terms (or, alternatively, under the terms of the ordinary General Public License).

To apply these terms, attach the following notices to the library. It is safest to attach them to the start of each source file to most effectively convey the exclusion of warranty; and each file should have at least the "copyright" line and a pointer to where the full notice is found.

<one line to give the library's name and a brief idea of what it does.>

Copyright (C) <year> <name of author>

This library is free software; you can redistribute it and/or modify it under the terms of the GNU Library General Public License as published by the Free Software Foundation; either version 2 of the License, or (at your option) any later version.

This library is distributed in the hope that it will be useful, but WITHOUT ANY WARRANTY; without even the implied warranty of MERCHANTABILITY or FITNESS FOR A PARTICULAR PURPOSE. See the GNU Library General Public License for more details.

You should have received a copy of the GNU Library General Public License along with this library; if not, write to the Free Software Foundation, Inc., 51 Franklin St, Fifth Floor, Boston, MA 02110-1301, USA.

Also add information on how to contact you by electronic and paper mail.

You should also get your employer (if you work as a programmer) or your school, if any, to sign a "copyright disclaimer" for the library, if necessary. Here is a sample; alter the names:

Yoyodyne, Inc., hereby disclaims all copyright interest in the library 'Frob' (a library for tweaking knobs) written by James Random Hacker.

<signature of Ty Coon>, 1 April 1990

Ty Coon, President of Vice

That's all there is to it!

■ About bison_parser

Conditions for Using Bison

The distribution terms for Bison-generated parsers permit using the parsers in nonfree programs. Before Bison version 2.2, these extra permissions applied only when Bison was generating LALR(1) parsers in C. And before Bison version 1.24, Bison-generated parsers could be used only in programs that were free software.

The other GNU programming tools, such as the GNU C compiler, have never had such a requirement. They could always be used for nonfree software. The reason Bison was different was not due to a special policy decision; it resulted from applying the usual General Public License to all of the Bison source code.

The main output of the Bison utility²the Bison parser implementation file³contains a verbatim copy of a sizable piece of Bison, which is the code for the parser's implementation. (The actions from your grammar are inserted into this implementation at one point, but most of the rest of the implementation is not changed.) When we applied the GPL terms to the skeleton code for the parser's implementation, the effect was to restrict the use of Bison output to free software.

We didn't change the terms because of sympathy for people who want to make software proprietary. Software should be free. But we concluded that limiting Bison's use to free software was doing little to encourage people to make other software free. So we decided to make the practical conditions for using Bison match the practical conditions for using the other GNU tools.

This exception applies when Bison is generating code for a parser. You can tell whether the exception applies to a Bison output file by inspecting the file for text beginning with "As a special exception...". The text spells out the exact terms of the exception.

■ About cURL, libcurl

COPYRIGHT AND PERMISSION NOTICE

Copyright © 1996 - 2009, Daniel Stenberg, <daniel@haxx.se>.
All rights reserved.

Permission to use, copy, modify, and distribute this software for any purpose with or without fee is hereby granted, provided that the above copyright notice and this permission notice appear in all copies.

THE SOFTWARE IS PROVIDED "AS IS", WITHOUT WARRANTY OF ANY KIND, EXPRESS OR IMPLIED, INCLUDING BUT NOT LIMITED TO THE WARRANTIES OF MERCHANTABILITY, FITNESS FOR A PARTICULAR PURPOSE AND NONINFRINGEMENT OF THIRD PARTY RIGHTS. IN NO EVENT SHALL THE AUTHORS OR COPYRIGHT HOLDERS BE LIABLE FOR ANY CLAIM, DAMAGES OR OTHER LIABILITY, WHETHER IN AN ACTION OF CONTRACT, TORT OR OTHERWISE, ARISING FROM, OUT OF OR IN CONNECTION WITH THE SOFTWARE OR THE USE OR OTHER DEALINGS IN THE SOFTWARE.

Except as contained in this notice, the name of a copyright holder shall not be used in advertising or otherwise to promote the sale, use or other dealings in this Software without prior written authorization of the copyright holder.

■ About c-ares

Copyright 1998 by the Massachusetts Institute of Technology.

Permission to use, copy, modify, and distribute this software and its documentation for any purpose and without fee is hereby granted, provided that the above copyright notice appear in all copies and that both that copyright notice and this permission notice appear in supporting documentation, and that the name of M.I.T. not be used in advertising or publicity pertaining to distribution of the software without specific, written prior permission.

M.I.T. makes no representations about the suitability of this software for any purpose. It is provided "as is" without express or implied warranty.

■ About Expat

Copyright © 1998, 1999, 2000 Thai Open Source Software Center Ltd
and Clark Cooper

Copyright © 2001, 2002, 2003, 2004, 2005, 2006 Expat maintainers.

Permission is hereby granted, free of charge, to any person obtaining a copy of this software and associated documentation files (the "Software"), to deal in the Software without restriction, including without limitation the rights to use, copy, modify, merge, publish, distribute, sublicense, and/or sell copies of the Software, and to permit persons to whom the Software is furnished to do so, subject to the following conditions:

The above copyright notice and this permission notice shall be included in all copies or substantial portions of the Software.

THE SOFTWARE IS PROVIDED "AS IS", WITHOUT WARRANTY OF ANY KIND, EXPRESS OR IMPLIED, INCLUDING BUT NOT LIMITED TO THE WARRANTIES OF MERCHANTABILITY, FITNESS FOR A PARTICULAR PURPOSE AND NONINFRINGEMENT. IN NO EVENT SHALL THE AUTHORS OR COPYRIGHT HOLDERS BE LIABLE FOR ANY CLAIM, DAMAGES OR OTHER LIABILITY, WHETHER IN AN ACTION OF CONTRACT, TORT OR OTHERWISE, ARISING FROM, OUT OF OR IN CONNECTION WITH THE SOFTWARE OR THE USE OR OTHER DEALINGS IN THE SOFTWARE.

■ About libxml2

Except where otherwise noted in the source code (e.g. the files hash.c, list.c and the trio files, which are covered by a similar licence but with different Copyright notices) all the files are:

Copyright © 1998-2003 Daniel Veillard. All Rights Reserved.

Permission is hereby granted, free of charge, to any person obtaining a copy of this software and associated documentation files (the "Software"), to deal in the Software without restriction, including without limitation the rights to use, copy, modify, merge, publish, distribute, sublicense, and/or sell copies of the Software, and to permit persons to whom the Software is furnished to do so, subject to the following conditions:

The above copyright notice and this permission notice shall be included in all copies or substantial portions of the Software.

THE SOFTWARE IS PROVIDED "AS IS", WITHOUT WARRANTY OF ANY KIND, EXPRESS OR IMPLIED, INCLUDING BUT NOT LIMITED TO THE WARRANTIES OF MERCHANTABILITY, FITNESS FOR A PARTICULAR PURPOSE AND NONINFRINGEMENT. IN NO EVENT SHALL THE DANIEL VEILLARD BE LIABLE FOR ANY CLAIM, DAMAGES OR OTHER LIABILITY, WHETHER IN AN ACTION OF CONTRACT, TORT OR OTHERWISE, ARISING FROM, OUT OF OR IN CONNECTION WITH THE SOFTWARE OR THE USE OR OTHER DEALINGS IN THE SOFTWARE.

Except as contained in this notice, the name of Daniel Veillard shall not be used in advertising or otherwise to promote the sale, use or other dealings in this Software without prior written authorization from him.

■ About NTP

Copyright © University of Delaware 1992-2012

Permission to use, copy, modify, and distribute this software and its documentation for any purpose with or without fee is hereby granted, provided that the above copyright notice appears in all copies and that both the copyright notice and this permission notice appear in supporting documentation, and that the name University of Delaware not be used in advertising or publicity pertaining to distribution of the software without specific, written prior permission. The University of Delaware makes no representations about the suitability this software for any purpose. It is provided "as is" without express or implied warranty.

■ About tcpdump

License: BSD

Redistribution and use in source and binary forms, with or without modification, are permitted provided that the following conditions are met:

1. Redistributions of source code must retain the above copyright notice, this list of conditions and the following disclaimer.
2. Redistributions in binary form must reproduce the above copyright notice, this list of conditions and the following disclaimer in the documentation and/or other materials provided with the distribution.
3. The names of the authors may not be used to endorse or promote products derived from this software without specific prior written permission.

THIS SOFTWARE IS PROVIDED "AS IS" AND WITHOUT ANY EXPRESS OR IMPLIED WARRANTIES, INCLUDING, WITHOUT LIMITATION, THE IMPLIED WARRANTIES OF MERCHANTABILITY AND FITNESS FOR A PARTICULAR PURPOSE.

■ About tinyxml

www.sourceforge.net/projects/tinyxml

Original code (2.0 and earlier) copyright © 2000-2006 Lee Thomason
(www.grinninglizard.com)

This software is provided 'as-is', without any express or implied warranty. In no event will the authors be held liable for any damages arising from the use of this software.

Permission is granted to anyone to use this software for any purpose, including commercial applications, and to alter it and redistribute it freely, subject to the following restrictions:

1. The origin of this software must not be misrepresented; you must not claim that you wrote the original software. If you use this software in a product, an acknowledgment in the product documentation would be appreciated but is not required.
2. Altered source versions must be plainly marked as such, and must not be misrepresented as being the original software.
3. This notice may not be removed or altered from any source distribution.

■ About dmalloc

This is a version (aka dmalloc) of malloc/free/realloc written by Doug Lea and released to the public domain, as explained at <http://creativecommons.org/licenses/publicdomain>. Send questions, comments, complaints, performance data, etc to dl@cs.oswego.edu.

THIS SOFTWARE IS PROVIDED BY THE CRYPTIX FOUNDATION LIMITED AND CONTRIBUTORS "AS IS" AND ANY EXPRESS OR IMPLIED WARRANTIES, INCLUDING, BUT NOT LIMITED TO, THE IMPLIED WARRANTIES OF MERCHANTABILITY AND FITNESS FOR A PARTICULAR PURPOSE ARE DISCLAIMED. IN NO EVENT SHALL THE CRYPTIX FOUNDATION LIMITED OR CONTRIBUTORS BE LIABLE FOR ANY DIRECT, INDIRECT, INCIDENTAL, SPECIAL, EXEMPLARY, OR CONSEQUENTIAL DAMAGES (INCLUDING, BUT NOT LIMITED TO, PROCUREMENT OF SUBSTITUTE GOODS OR SERVICES; LOSS OF USE, DATA, OR PROFITS; OR BUSINESS INTERRUPTION) HOWEVER CAUSED AND ON ANY THEORY OF LIABILITY, WHETHER IN CONTRACT, STRICT LIABILITY, OR TORT (INCLUDING NEGLIGENCE OR OTHERWISE) ARISING IN ANY WAY OUT OF THE USE OF THIS SOFTWARE, EVEN IF ADVISED OF THE POSSIBILITY OF SUCH DAMAGE.

■ About DMG's dtoa and strtod

The author of this software is David M. Gay.

Copyright © 1991, 2000, 2001 by Lucent Technologies.

Permission to use, copy, modify, and distribute this software for any purpose without fee is hereby granted, provided that this entire notice is included in all copies of any software which is or includes a copy or modification of this software and in all copies of the supporting documentation for such software.

THIS SOFTWARE IS BEING PROVIDED "AS IS", WITHOUT ANY EXPRESS OR IMPLIED WARRANTY. IN PARTICULAR, NEITHER THE AUTHOR NOR LUCENT MAKES ANY REPRESENTATION OR WARRANTY OF ANY KIND CONCERNING THE MERCHANTABILITY OF THIS SOFTWARE OR ITS FITNESS FOR ANY PARTICULAR PURPOSE.

■ About EMX_sprintf_sscanf

The emx libraries are not distributed under the GPL. Linking an application with the emx libraries does not cause the executable to be covered by the GNU General Public License. You are allowed to change and copy the emx library sources if you keep the copyright message intact. If you improve the emx libraries, please send your enhancements to the emx author (you should copyright your enhancements similar to the existing emx libraries).

■ About Lua

The MIT License (MIT)

Copyright © 1994-2013 Lua.org, PUC-Rio.

Permission is hereby granted, free of charge, to any person obtaining a copy of this software and associated documentation files (the "Software"), to deal in the Software without restriction, including without limitation the rights to use, copy, modify, merge, publish, distribute, sublicense, and/or sell copies of the Software, and to permit persons to whom the Software is furnished to do so, subject to the following conditions:

The above copyright notice and this permission notice shall be included in all copies or substantial portions of the Software.

THE SOFTWARE IS PROVIDED "AS IS", WITHOUT WARRANTY OF ANY KIND, EXPRESS OR IMPLIED, INCLUDING BUT NOT LIMITED TO THE WARRANTIES OF MERCHANTABILITY, FITNESS FOR A PARTICULAR PURPOSE AND NONINFRINGEMENT. IN NO EVENT SHALL THE AUTHORS OR COPYRIGHT HOLDERS BE LIABLE FOR ANY CLAIM, DAMAGES OR OTHER LIABILITY, WHETHER IN AN ACTION OF CONTRACT, TORT OR OTHERWISE, ARISING FROM, OUT OF OR IN CONNECTION WITH THE SOFTWARE OR THE USE OR OTHER DEALINGS IN THE SOFTWARE.

■ About ncurses

THE SOFTWARE IS PROVIDED "AS IS", WITHOUT WARRANTY OF ANY KIND, EXPRESS OR IMPLIED, INCLUDING BUT NOT LIMITED TO THE WARRANTIES OF MERCHANTABILITY, FITNESS FOR A PARTICULAR PURPOSE AND NONINFRINGEMENT. IN NO EVENT SHALL THE AUTHORS OR COPYRIGHT HOLDERS BE LIABLE FOR ANY CLAIM, DAMAGES OR OTHER LIABILITY, WHETHER IN AN ACTION OF CONTRACT, TORT OR OTHERWISE, ARISING FROM, OUT OF OR IN CONNECTION WITH THE SOFTWARE OR THE USE OR OTHER DEALINGS IN THE SOFTWARE.

Copyright © 1998-2000,2006 Free Software Foundation, Inc.

Permission is hereby granted, free of charge, to any person obtaining a copy of this software and associated documentation files (the "Software"), to deal in the Software without restriction, including without limitation the rights to use, copy, modify, merge, publish,-- distribute, distribute with modifications, sublicense, and/or sell copies of the Software, and to permit persons to whom the Software is furnished to do so, subject to the following conditions:

The above copyright notice and this permission notice shall be included in all copies or substantial portions of the Software.

THE SOFTWARE IS PROVIDED "AS IS", WITHOUT WARRANTY OF ANY KIND, EXPRESS OR IMPLIED, INCLUDING BUT NOT LIMITED TO THE WARRANTIES OF MERCHANTABILITY, FITNESS FOR A PARTICULAR PURPOSE AND NONINFRINGEMENT. IN NO EVENT SHALL THE ABOVE COPYRIGHT HOLDERS BE LIABLE FOR ANY CLAIM, DAMAGES OR OTHER LIABILITY, WHETHER IN AN ACTION OF CONTRACT, TORT OR OTHERWISE, ARISING FROM, OUT OF OR IN CONNECTION WITH THE SOFTWARE OR THE USE OR OTHER DEALINGS IN THE SOFTWARE.

Except as contained in this notice, the name(s) of the above copyright holders shall not be used in advertising or otherwise to promote the sale, use or other dealings in this Software without prior written authorization.

■ About popt

Copyright © 1998 Red Hat Software

Permission is hereby granted, free of charge, to any person obtaining a copy of this software and associated documentation files (the "Software"), to deal in the Software without restriction, including without limitation the rights to use, copy, modify, merge, publish, distribute, sublicense, and/or sell copies of the Software, and to permit persons to whom the Software is furnished to do so, subject to the following conditions:

The above copyright notice and this permission notice shall be included in all copies or substantial portions of the Software.

THE SOFTWARE IS PROVIDED "AS IS", WITHOUT WARRANTY OF ANY KIND, EXPRESS OR IMPLIED, INCLUDING BUT NOT LIMITED TO THE WARRANTIES OF MERCHANTABILITY, FITNESS FOR A PARTICULAR PURPOSE AND NONINFRINGEMENT. IN NO EVENT SHALL THE X CONSORTIUM BE LIABLE FOR ANY CLAIM, DAMAGES OR OTHER LIABILITY, WHETHER IN AN ACTION OF CONTRACT, TORT OR OTHERWISE, ARISING FROM, OUT OF OR IN CONNECTION WITH THE SOFTWARE OR THE USE OR OTHER DEALINGS IN THE SOFTWARE.

Except as contained in this notice, the name of the X Consortium shall not be used in advertising or otherwise to promote the sale, use or other dealings in this Software without prior written authorization from the X Consortium.

■ About protobug

Copyright © 2008, Google Inc. All rights reserved.

Redistribution and use in source and binary forms, with or without modification, are permitted provided that the following conditions are met:

1. Redistributions of source code must retain the above copyright notice, this list of conditions and the following disclaimer.
2. Redistributions in binary form must reproduce the above copyright notice, this list of conditions and the following disclaimer in the documentation and/or other materials provided with the distribution.
3. Neither the name of Google Inc. nor the names of its contributors may be used to endorse or promote products derived from this software without specific prior written permission.

THIS SOFTWARE IS PROVIDED BY THE COPYRIGHT HOLDERS AND CONTRIBUTORS "AS IS" AND ANY EXPRESS OR IMPLIED WARRANTIES, INCLUDING, BUT NOT LIMITED TO, THE IMPLIED WARRANTIES OF MERCHANTABILITY AND FITNESS FOR A PARTICULAR PURPOSE ARE DISCLAIMED. IN NO EVENT SHALL THE COPYRIGHT OWNER OR CONTRIBUTORS BE LIABLE FOR ANY DIRECT, INDIRECT, INCIDENTAL, SPECIAL, EXEMPLARY, OR CONSEQUENTIAL DAMAGES (INCLUDING, BUT NOT LIMITED TO, PROCUREMENT OF SUBSTITUTE GOODS OR SERVICES; LOSS OF USE, DATA, OR PROFITS; OR BUSINESS INTERRUPTION) HOWEVER CAUSED AND ON ANY THEORY OF LIABILITY, WHETHER IN CONTRACT, STRICT LIABILITY, OR TORT (INCLUDING NEGLIGENCE OR OTHERWISE) ARISING IN ANY WAY OUT OF THE USE OF THIS SOFTWARE, EVEN IF ADVISED OF THE POSSIBILITY OF SUCH DAMAGE.

Code generated by the Protocol Buffer compiler is owned by the owner of the input file used when generating it. This code is not standalone and requires a support library to be linked with it. This support library is itself covered by the above license.

■ About UnZip

Copyright © 1990-2009 Info-ZIP. All rights reserved.

For the purposes of this copyright and license, "Info-ZIP" is defined as the following set of individuals:

Mark Adler, John Bush, Karl Davis, Harald Denker, Jean-Michel Dubois, Jean-loup Gailly, Hunter Goatley, Ed Gordon, Ian Gorman, Chris Herberth, Dirk Haase, Greg Hartwig, Robert Heath, Jonathan Hudson, Paul Kienitz, David Kirschbaum, Johnny Lee, Onno van der Linden, Igor Mandrichenko, Steve P. Miller, Sergio Monesi, Keith Owens, George Petrov, Greg Roelofs, Kai Uwe Rommel, Steve Salisbury, Dave Smith, Steven M. Schweda, Christian Spieler, Cosmin Truta, Antoine Verheijen, Paul von Behren, Rich Wales, Mike White.

This software is provided "as is," without warranty of any kind, express or implied. In no event shall Info-ZIP or its contributors be held liable for any direct, indirect, incidental, special or consequential damages arising out of the use of or inability to use this software.

Permission is granted to anyone to use this software for any purpose, including commercial applications, and to alter it and redistribute it freely, subject to the above disclaimer and the following restrictions:

1. Redistributions of source code (in whole or in part) must retain the above copyright notice, definition, disclaimer, and this list of conditions.
2. Redistributions in binary form (compiled executables and libraries) must reproduce the above copyright notice, definition, disclaimer, and this list of conditions in documentation and/or other materials provided with the distribution. Additional documentation is not needed for executables where a command line license option provides these and a note regarding this option is in the executable's startup banner. The sole exception to this condition is redistribution of a standard UnZipSFX binary (including SFXWiz) as part of a self-extracting archive; that is permitted without inclusion of this license, as long as the normal SFX banner has not been removed from the binary or disabled.
3. Altered versions--including, but not limited to, ports to new operating systems, existing ports with new graphical interfaces, versions with modified or added functionality, and dynamic, shared, or static library versions not from Info-ZIP--must be plainly marked as such and must not be misrepresented as being the original source or, if binaries, compiled from the original source. Such altered versions also must not be misrepresented as being Info-ZIP releases--including, but not limited to, labeling of the altered versions with the names "Info-ZIP" (or any variation thereof, including, but not limited to, different capitalizations), "Pocket UnZip," "WiZ" or "MacZip" without the explicit permission of Info-ZIP. Such altered versions are further prohibited from misrepresentative use of the Zip-Bugs or Info-ZIP e-mail addresses or the Info-ZIP URL(s), such as to imply Info-ZIP will provide support for the altered versions.
4. Info-ZIP retains the right to use the names "Info-ZIP," "Zip," "UnZip," "UnZipSFX," "WiZ," "MacZip," "Pocket Zip," and "MacZip" for its own source and binary releases.

■ About zlib

Copyright notice:

© 1995-2004 Jean-loup Gailly and Mark Adler

This software is provided 'as-is', without any express or implied warranty. In no event will the authors be held liable for any damages arising from the use of this software. Permission is granted to anyone to use this software for any purpose, including commercial applications, and to alter it and redistribute it freely, subject to the following restrictions:

1. The origin of this software must not be misrepresented; you must not claim that you wrote the original software. If you use this software in a product, an acknowledgment in the product documentation would be appreciated but is not required.
2. Altered source versions must be plainly marked as such, and must not be misrepresented as being the original software.
3. This notice may not be removed or altered from any source distribution.

Jean-loup Gailly Mark Adler
jloup@gzip.org madler@alumni.caltech.edu

If you use the zlib library in a product, we would appreciate *not* receiving lengthy legal documents to sign. The sources are provided for free but without warranty of any kind. The library has been entirely written by Jean-loup Gailly and Mark Adler; it does not include third-party code.

If you redistribute modified sources, we would appreciate that you include in the file ChangeLog history information documenting your changes. Please read the FAQ for more information on the distribution of modified source versions.

■ About 3DES

3DES
Des3Cipher - the triple-DES encryption method

Copyright © 1996 by Jef Poskanzer <jef@mail.acme.com>. All rights reserved.

Redistribution and use in source and binary forms, with or without modification, are permitted provided that the following conditions are met:

1. Redistributions of source code must retain the above copyright notice, this list of conditions and the following disclaimer.
2. Redistributions in binary form must reproduce the above copyright notice, this list of conditions and the following disclaimer in the documentation and/or other materials provided with the distribution.

THIS SOFTWARE IS PROVIDED BY THE AUTHOR AND CONTRIBUTORS "AS IS" AND ANY EXPRESS OR IMPLIED WARRANTIES, INCLUDING, BUT NOT LIMITED TO, THE IMPLIED WARRANTIES OF MERCHANTABILITY AND FITNESS FOR A PARTICULAR PURPOSE ARE DISCLAIMED. IN NO EVENT SHALL THE AUTHOR OR CONTRIBUTORS BE LIABLE FOR ANY DIRECT, INDIRECT, INCIDENTAL, SPECIAL, EXEMPLARY, OR CONSEQUENTIAL DAMAGES (INCLUDING, BUT NOT LIMITED TO, PROCUREMENT OF SUBSTITUTE GOODS OR SERVICES; LOSS OF USE, DATA, OR PROFITS; OR BUSINESS INTERRUPTION) HOWEVER CAUSED AND ON ANY THEORY OF LIABILITY, WHETHER IN CONTRACT, STRICT LIABILITY, OR TORT (INCLUDING NEGLIGENCE OR OTHERWISE) ARISING IN ANY WAY OUT OF THE USE OF THIS SOFTWARE, EVEN IF ADVISED OF THE POSSIBILITY OF SUCH DAMAGE.

Visit the ACME Labs Java page for up-to-date versions of this and other fine Java utilities: <http://www.acme.com/java/>

■ About AES

Cryptix General License

Copyright © 1995-2005 The Cryptix Foundation Limited. All rights reserved.

Redistribution and use in source and binary forms, with or without modification, are permitted provided that the following conditions are met:

1. Redistributions of source code must retain the copyright notice, this list of conditions and the following disclaimer.
2. Redistributions in binary form must reproduce the above copyright notice, this list of conditions and the following disclaimer in the documentation and/or other materials provided with the distribution.

■ About DES

DES
DesCipher - the DES encryption method

The meat of this code is by Dave Zimmerman <dzimm@widget.com>, and is:

Copyright © 1996 Widget Workshop, Inc. All Rights Reserved.

Permission to use, copy, modify, and distribute this software and its documentation for NON-COMMERCIAL or COMMERCIAL purposes and without fee is hereby granted, provided that this copyright notice is kept intact.

WIDGET WORKSHOP MAKES NO REPRESENTATIONS OR WARRANTIES ABOUT THE SUITABILITY OF THE SOFTWARE, EITHER EXPRESS OR IMPLIED, INCLUDING BUT NOT LIMITED TO THE IMPLIED WARRANTIES OF MERCHANTABILITY, FITNESS FOR A PARTICULAR PURPOSE, OR NON-INFRINGEMENT. WIDGET WORKSHOP SHALL NOT BE LIABLE FOR ANY DAMAGES SUFFERED BY LICENSEE AS A RESULT OF USING, MODIFYING OR DISTRIBUTING THIS SOFTWARE OR ITS DERIVATIVES.

THIS SOFTWARE IS NOT DESIGNED OR INTENDED FOR USE OR RESALE AS ON-LINE CONTROL EQUIPMENT IN HAZARDOUS ENVIRONMENTS REQUIRING FAIL-SAFE PERFORMANCE, SUCH AS IN THE OPERATION OF NUCLEAR FACILITIES, AIRCRAFT NAVIGATION OR COMMUNICATION SYSTEMS, AIR TRAFFIC CONTROL, DIRECT LIFE SUPPORT MACHINES, OR WEAPONS SYSTEMS, IN WHICH THE FAILURE OF THE SOFTWARE COULD LEAD DIRECTLY TO DEATH, PERSONAL INJURY, OR SEVERE PHYSICAL OR ENVIRONMENTAL DAMAGE ("HIGH RISK ACTIVITIES"). WIDGET WORKSHOP SPECIFICALLY DISCLAIMS ANY EXPRESS OR IMPLIED WARRANTY OF FITNESS FOR HIGH RISK ACTIVITIES.

The rest of the code is:

Copyright © 1996 by Jef Poskanzer <jef@mail.acme.com>. All rights reserved.

Redistribution and use in source and binary forms, with or without modification, are permitted provided that the following conditions are met:

1. Redistributions of source code must retain the above copyright notice, this list of conditions and the following disclaimer.
2. Redistributions in binary form must reproduce the above copyright notice, this list of conditions and the following disclaimer in the documentation and/or other materials provided with the distribution.

THIS SOFTWARE IS PROVIDED BY THE AUTHOR AND CONTRIBUTORS "AS IS" AND ANY EXPRESS OR IMPLIED WARRANTIES, INCLUDING, BUT NOT LIMITED TO, THE IMPLIED WARRANTIES OF MERCHANTABILITY AND FITNESS FOR A PARTICULAR PURPOSE ARE DISCLAIMED. IN NO EVENT SHALL THE AUTHOR OR CONTRIBUTORS BE LIABLE FOR ANY DIRECT, INDIRECT, INCIDENTAL, SPECIAL, EXEMPLARY, OR CONSEQUENTIAL DAMAGES (INCLUDING, BUT NOT LIMITED TO, PROCUREMENT OF SUBSTITUTE GOODS OR SERVICES; LOSS OF USE, DATA, OR PROFITS; OR BUSINESS INTERRUPTION) HOWEVER CAUSED AND ON ANY THEORY OF LIABILITY, WHETHER IN CONTRACT, STRICT LIABILITY, OR TORT (INCLUDING NEGLIGENCE OR OTHERWISE) ARISING IN ANY WAY OUT OF THE USE OF THIS SOFTWARE, EVEN IF ADVISED OF THE POSSIBILITY OF SUCH DAMAGE.

Visit the ACME Labs Java page for up-to-date versions of this and other fine Java utilities: <http://www.acme.com/java/>

■ About OpenSSL

Copyright © 1998-2008 The OpenSSL Project. All rights reserved.

Redistribution and use in source and binary forms, with or without modification, are permitted provided that the following conditions are met:

1. Redistributions of source code must retain the above copyright notice, this list of conditions and the following disclaimer.
2. Redistributions in binary form must reproduce the above copyright notice, this list of conditions and the following disclaimer in the documentation and/or other materials provided with the distribution.
3. All advertising materials mentioning features or use of this software must display the following acknowledgment:
"This product includes software developed by the OpenSSL Project for use in the OpenSSL Toolkit. (<http://www.openssl.org/>)"
4. The names "OpenSSL Toolkit" and "OpenSSL Project" must not be used to endorse or promote products derived from this software without prior written permission. For written permission, please contact openssl-core@openssl.org.
5. Products derived from this software may not be called "OpenSSL" nor may "OpenSSL" appear in their names without prior written permission of the OpenSSL Project.
6. Redistributions of any form whatsoever must retain the following acknowledgment:
"This product includes software developed by the OpenSSL Project for use in the OpenSSL Toolkit (<http://www.openssl.org/>)"

THIS SOFTWARE IS PROVIDED BY THE OPENSSL PROJECT "AS IS" AND ANY EXPRESSED OR IMPLIED WARRANTIES, INCLUDING, BUT NOT LIMITED TO, THE IMPLIED WARRANTIES OF MERCHANTABILITY AND FITNESS FOR A PARTICULAR PURPOSE ARE DISCLAIMED. IN NO EVENT SHALL THE OPENSSL PROJECT OR ITS CONTRIBUTORS BE LIABLE FOR ANY DIRECT, INDIRECT, INCIDENTAL, SPECIAL, EXEMPLARY, OR CONSEQUENTIAL DAMAGES (INCLUDING, BUT NOT LIMITED TO, PROCUREMENT OF SUBSTITUTE GOODS OR SERVICES; LOSS OF USE, DATA, OR PROFITS; OR BUSINESS INTERRUPTION) HOWEVER CAUSED AND ON ANY THEORY OF LIABILITY, WHETHER IN CONTRACT, STRICT LIABILITY, OR TORT (INCLUDING NEGLIGENCE OR OTHERWISE) ARISING IN ANY WAY OUT OF THE USE OF THIS SOFTWARE, EVEN IF ADVISED OF THE POSSIBILITY OF SUCH DAMAGE.

This product includes cryptographic software written by Eric Young (ey@cryptsoft.com). This product includes software written by Tim Hudson (tjh@cryptsoft.com).

Original SSLeay License

Copyright © 1995-1998 Eric Young (ey@cryptsoft.com) All rights reserved.

This package is an SSL implementation written by Eric Young (ey@cryptsoft.com). The implementation was written so as to conform with Netscapes SSL.

This library is free for commercial and non-commercial use as long as the following conditions are adhered to. The following conditions apply to all code found in this distribution, be it the RC4, RSA, lhash, DES, etc., code; not just the SSL code. The SSL documentation included with this distribution is covered by the same copyright terms except that the holder is Tim Hudson (tjh@cryptsoft.com).

Copyright remains Eric Young's, and as such any Copyright notices in the code are not to be removed. If this package is used in a product, Eric Young should be given attribution as the author of the parts of the library used. This can be in the form of a textual message at program startup or in documentation (online or textual) provided with the package.

Redistribution and use in source and binary forms, with or without modification, are permitted provided that the following conditions are met:

1. Redistributions of source code must retain the copyright notice, this list of conditions and the following disclaimer.
2. Redistributions in binary form must reproduce the above copyright notice, this list of conditions and the following disclaimer in the documentation and/or other materials provided with the distribution.

3. All advertising materials mentioning features or use of this software must display the following acknowledgement:
"This product includes cryptographic software written by Eric Young (ey@cryptsoft.com)" The word "cryptographic" can be left out if the routines from the library being used are not cryptographic related :-).
4. If you include any Windows specific code (or a derivative thereof) from the apps directory (application code) you must include an acknowledgement:
"This product includes software written by Tim Hudson (tjh@cryptsoft.com)"

THIS SOFTWARE IS PROVIDED BY ERIC YOUNG "AS IS" AND ANY EXPRESS OR IMPLIED WARRANTIES, INCLUDING, BUT NOT LIMITED TO, THE IMPLIED WARRANTIES OF MERCHANTABILITY AND FITNESS FOR A PARTICULAR PURPOSE ARE DISCLAIMED. IN NO EVENT SHALL THE AUTHOR OR CONTRIBUTORS BE LIABLE FOR ANY DIRECT, INDIRECT, INCIDENTAL, SPECIAL, EXEMPLARY, OR CONSEQUENTIAL DAMAGES (INCLUDING, BUT NOT LIMITED TO, PROCUREMENT OF SUBSTITUTE GOODS OR SERVICES; LOSS OF USE, DATA, OR PROFITS; OR BUSINESS INTERRUPTION) HOWEVER CAUSED AND ON ANY THEORY OF LIABILITY, WHETHER IN CONTRACT, STRICT LIABILITY, OR TORT (INCLUDING NEGLIGENCE OR OTHERWISE) ARISING IN ANY WAY OUT OF THE USE OF THIS SOFTWARE, EVEN IF ADVISED OF THE POSSIBILITY OF SUCH DAMAGE.

The licence and distribution terms for any publically available version or derivative of this code cannot be changed. i.e. this code cannot simply be copied and put under another distribution licence [including the GNU Public Licence.]

■ About WPA Supplicant, WPA Supplicant (WPS)

WPA Supplicant

Copyright © 2003-2012, Jouni Malinen <jj@w1.fi> and contributors

All Rights Reserved.

This program is licensed under the BSD license (the one with advertisement clause removed).

If you are submitting changes to the project, please see CONTRIBUTIONS file for more instructions.

License

This software may be distributed, used, and modified under the terms of BSD license:

Redistribution and use in source and binary forms, with or without modification, are permitted provided that the following conditions are met:

1. Redistributions of source code must retain the above copyright notice, this list of conditions and the following disclaimer.
2. Redistributions in binary form must reproduce the above copyright notice, this list of conditions and the following disclaimer in the documentation and/or other materials provided with the distribution.
3. Neither the name(s) of the above-listed copyright holder(s) nor the names of its contributors may be used to endorse or promote products derived from this software without specific prior written permission.

THIS SOFTWARE IS PROVIDED BY THE COPYRIGHT HOLDERS AND CONTRIBUTORS "AS IS" AND ANY EXPRESS OR IMPLIED WARRANTIES, INCLUDING, BUT NOT LIMITED TO, THE IMPLIED WARRANTIES OF MERCHANTABILITY AND FITNESS FOR A PARTICULAR PURPOSE ARE DISCLAIMED. IN NO EVENT SHALL THE COPYRIGHT OWNER OR CONTRIBUTORS BE LIABLE FOR ANY DIRECT, INDIRECT, INCIDENTAL, SPECIAL, EXEMPLARY, OR CONSEQUENTIAL DAMAGES (INCLUDING, BUT NOT LIMITED TO, PROCUREMENT OF SUBSTITUTE GOODS OR SERVICES; LOSS OF USE, DATA, OR PROFITS; OR BUSINESS INTERRUPTION) HOWEVER CAUSED AND ON ANY THEORY OF LIABILITY, WHETHER IN CONTRACT, STRICT LIABILITY, OR TORT (INCLUDING NEGLIGENCE OR OTHERWISE) ARISING IN ANY WAY OUT OF THE USE OF THIS SOFTWARE, EVEN IF ADVISED OF THE POSSIBILITY OF SUCH DAMAGE.

■ About FreeType

The FreeType Project LICENSE

2006-Jan-27

Copyright 1996-2002, 2006 by

David Turner, Robert Wilhelm, and Werner Lemberg

Introduction

The FreeType Project is distributed in several archive packages; some of them may contain, in addition to the FreeType font engine, various tools and contributions which rely on, or relate to, the FreeType Project.

This license applies to all files found in such packages, and which do not fall under their own explicit license. The license affects thus the FreeType font engine, the test programs, documentation and makefiles, at the very least.

This license was inspired by the BSD, Artistic, and IJG (Independent JPEG Group) licenses, which all encourage inclusion and use of free software in commercial and freeware products alike. As a consequence, its main points are that:

- We don't promise that this software works. However, we will be interested in any kind of bug reports. ('as is' distribution)
- You can use this software for whatever you want, in parts or full form, without having to pay us. ('royalty-free' usage)
- You may not pretend that you wrote this software. If you use it, or only parts of it, in a program, you must acknowledge somewhere in your documentation that you have used the FreeType code. ('credits')

We specifically permit and encourage the inclusion of this software, with or without modifications, in commercial products. We disclaim all warranties covering The FreeType Project and assume no liability related to The FreeType Project.

Finally, many people asked us for a preferred form for a credit/disclaimer to use in compliance with this license. We thus encourage you to use the following text:

Portions of this software are copyright © <year> The FreeType Project (www.freetype.org). All rights reserved.

Please replace <year> with the value from the FreeType version you actually use.

Legal Terms

0. Definitions

Throughout this license, the terms 'package', 'FreeType Project', and 'FreeType archive' refer to the set of files originally distributed by the authors (David Turner, Robert Wilhelm, and Werner Lemberg) as the 'FreeType Project', be they named as alpha, beta or final release.

'You' refers to the licensee, or person using the project, where 'using' is a generic term including compiling the project's source code as well as linking it to form a 'program' or 'executable'. This program is referred to as 'a program using the FreeType engine'.

This license applies to all files distributed in the original FreeType Project, including all source code, binaries and documentation, unless otherwise stated in the file in its original, unmodified form as distributed in the original archive. If you are unsure whether or not a particular file is covered by this license, you must contact us to verify this.

The FreeType Project is copyright © 1996-2000 by David Turner, Robert Wilhelm, and Werner Lemberg. All rights reserved except as specified below.

1. No Warranty

THE FREETYPE PROJECT IS PROVIDED 'AS IS' WITHOUT WARRANTY OF ANY KIND, EXPRESS OR IMPLIED, INCLUDING, BUT NOT LIMITED TO, WARRANTIES OF MERCHANTABILITY AND FITNESS FOR A PARTICULAR PURPOSE. IN NO EVENT WILL ANY OF THE AUTHORS OR COPYRIGHT HOLDERS BE LIABLE FOR ANY DAMAGES CAUSED BY THE USE OR THE INABILITY TO USE, OF THE FREETYPE PROJECT.

2. Redistribution

This license grants a worldwide, royalty-free, perpetual and irrevocable right and license to use, execute, perform, compile, display, copy, create derivative works of, distribute and sublicense the FreeType Project (in both source and object code forms) and derivative works thereof for any purpose; and to authorize others to exercise some or all of the rights granted herein, subject to the following conditions:

- Redistribution of source code must retain this license file ('FTL.TXT') unaltered; any additions, deletions or changes to the original files must be clearly indicated in accompanying documentation. The copyright notices of the unaltered, original files must be preserved in all copies of source files.
- Redistribution in binary form must provide a disclaimer that states that the software is based in part of the work of the FreeType Team, in the distribution documentation. We also encourage you to put an URL to the FreeType web page in your documentation, though this isn't mandatory.

These conditions apply to any software derived from or based on the FreeType Project, not just the unmodified files. If you use our work, you must acknowledge us. However, no fee need be paid to us.

3. Advertising

Neither the FreeType authors and contributors nor you shall use the name of the other for commercial, advertising, or promotional purposes without specific prior written permission.

We suggest, but do not require, that you use one or more of the following phrases to refer to this software in your documentation or advertising materials: 'FreeType Project', 'FreeType Engine', 'FreeType library', or 'FreeType Distribution'.

As you have not signed this license, you are not required to accept it. However, as the FreeType Project is copyrighted material, only this license, or another one contracted with the authors, grants you the right to use, distribute, and modify it. Therefore, by using, distributing, or modifying the FreeType Project, you indicate that you understand and accept all the terms of this license.

4. Contacts

There are two mailing lists related to FreeType:
freetype@nongnu.org

Discusses general use and applications of FreeType, as well as future and wanted additions to the library and distribution. If you are looking for support, start in this list if you haven't found anything to help you in the documentation.

o freetype-devel@nongnu.org

Discusses bugs, as well as engine internals, design issues, specific licenses, porting, etc.

Our home page can be found at

<http://www.freetype.org>

■ About fonts

Fonts are © Bitstream (see below). DejaVu changes are in public domain.

Glyphs imported from Arev fonts are © Tavmjong Bah (see below)

Bitstream Vera Fonts Copyright

Copyright © 2003 by Bitstream, Inc. All Rights Reserved. Bitstream Vera is a trademark of Bitstream, Inc.

Permission is hereby granted, free of charge, to any person obtaining a copy of the fonts accompanying this license ("Fonts") and associated documentation files (the "Font Software"), to reproduce and distribute the Font Software, including without limitation the rights to use, copy, merge, publish, distribute, and/or sell copies of the Font Software, and to permit persons to whom the Font Software is furnished to do so, subject to the following conditions:

The above copyright and trademark notices and this permission notice shall be included in all copies of one or more of the Font Software typefaces.

The Font Software may be modified, altered, or added to, and in particular the designs of glyphs or characters in the Fonts may be modified and additional glyphs or characters may be added to the Fonts, only if the fonts are renamed to names not containing either the words "Bitstream" or the word "Vera".

This License becomes null and void to the extent applicable to Fonts or Font Software that has been modified and is distributed under the "Bitstream Vera" names.

The Font Software may be sold as part of a larger software package but no copy of one or more of the Font Software typefaces may be sold by itself.

THE FONT SOFTWARE IS PROVIDED "AS IS", WITHOUT WARRANTY OF ANY KIND, EXPRESS OR IMPLIED, INCLUDING BUT NOT LIMITED TO ANY WARRANTIES OF MERCHANTABILITY, FITNESS FOR A PARTICULAR PURPOSE AND NONINFRINGEMENT OF COPYRIGHT, PATENT, TRADEMARK, OR OTHER RIGHT. IN NO EVENT SHALL BITSTREAM OR THE GNOME FOUNDATION BE LIABLE FOR ANY CLAIM, DAMAGES OR OTHER LIABILITY, INCLUDING ANY GENERAL, SPECIAL, INDIRECT, INCIDENTAL, OR CONSEQUENTIAL DAMAGES, WHETHER IN AN ACTION OF CONTRACT, TORT OR OTHERWISE, ARISING FROM, OUT OF THE USE OR INABILITY TO USE THE FONT SOFTWARE OR FROM OTHER DEALINGS IN THE FONT SOFTWARE.

Except as contained in this notice, the names of Gnome, the Gnome Foundation, and Bitstream Inc., shall not be used in advertising or otherwise to promote the sale, use or other dealings in this Font Software without prior written authorization from the Gnome Foundation or Bitstream Inc., respectively. For further information, contact: fonts at gnome dot org.

Arev Fonts Copyright

Copyright © 2006 by Tavmjong Bah. All Rights Reserved.

Permission is hereby granted, free of charge, to any person obtaining a copy of the fonts accompanying this license ("Fonts") and associated documentation files (the "Font Software"), to reproduce and distribute the modifications to the Bitstream Vera Font Software, including without limitation the rights to use, copy, merge, publish, distribute, and/or sell copies of the Font Software, and to permit persons to whom the Font Software is furnished to do so, subject to the following conditions:

The above copyright and trademark notices and this permission notice shall be included in all copies of one or more of the Font Software typefaces.

The Font Software may be modified, altered, or added to, and in particular the designs of glyphs or characters in the Fonts may be modified and additional glyphs or characters may be added to the Fonts, only if the fonts are renamed to names not containing either the words "Tavmjong Bah" or the word "Arev".

This License becomes null and void to the extent applicable to Fonts or Font Software that has been modified and is distributed under the "Tavmjong Bah Arev" names.

The Font Software may be sold as part of a larger software package but no copy of one or more of the Font Software typefaces may be sold by itself.

THE FONT SOFTWARE IS PROVIDED "AS IS", WITHOUT WARRANTY OF ANY KIND, EXPRESS OR IMPLIED, INCLUDING BUT NOT LIMITED TO ANY WARRANTIES OF MERCHANTABILITY, FITNESS FOR A PARTICULAR PURPOSE AND NONINFRINGEMENT OF COPYRIGHT, PATENT, TRADEMARK, OR OTHER RIGHT. IN NO EVENT SHALL TAVMJONG BAH BE LIABLE FOR ANY CLAIM, DAMAGES OR OTHER LIABILITY, INCLUDING ANY GENERAL, SPECIAL, INDIRECT, INCIDENTAL, OR CONSEQUENTIAL DAMAGES, WHETHER IN AN ACTION OF CONTRACT, TORT OR OTHERWISE, ARISING FROM, OUT OF THE USE OR INABILITY TO USE THE FONT SOFTWARE OR FROM OTHER DEALINGS IN THE FONT SOFTWARE.

Except as contained in this notice, the name of Tavmjong Bah shall not be used in advertising or otherwise to promote the sale, use or other dealings in this Font Software without prior written authorization from Tavmjong Bah. For further information, contact: tavmjong@free. fr.

■ About International Components for Unicode

ICU License - ICU 1.8.1 and later
COPYRIGHT AND PERMISSION NOTICE

Copyright © 1995-2003 International Business Machines Corporation and others
All rights reserved.

Permission is hereby granted, free of charge, to any person obtaining a copy of this software and associated documentation files (the "Software"), to deal in the Software without restriction, including without limitation the rights to use, copy, modify, merge, publish, distribute, and/or sell copies of the Software, and to permit persons to whom the Software is furnished to do so, provided that the above copyright notice(s) and this permission notice appear in all copies of the Software and that both the above copyright notice(s) and this permission notice appear in supporting documentation.

THE SOFTWARE IS PROVIDED "AS IS", WITHOUT WARRANTY OF ANY KIND, EXPRESS OR IMPLIED, INCLUDING BUT NOT LIMITED TO THE WARRANTIES OF MERCHANTABILITY, FITNESS FOR A PARTICULAR PURPOSE AND NONINFRINGEMENT OF THIRD PARTY RIGHTS. IN NO EVENT SHALL THE COPYRIGHT HOLDER OR HOLDERS INCLUDED IN THIS NOTICE BE LIABLE FOR ANY CLAIM, OR ANY SPECIAL INDIRECT OR CONSEQUENTIAL DAMAGES, OR ANY DAMAGES WHATSOEVER RESULTING FROM LOSS OF USE, DATA OR PROFITS, WHETHER IN AN ACTION OF CONTRACT, NEGLIGENCE OR OTHER TORTIOUS ACTION, ARISING OUT OF OR IN CONNECTION WITH THE USE OR PERFORMANCE OF THIS SOFTWARE.

Except as contained in this notice, the name of a copyright holder shall not be used in advertising or otherwise to promote the sale, use or other dealings in this Software without prior written authorization of the copyright holder.

All trademarks and registered trademarks mentioned herein are the property of their respective owners.

■ About Independent JPEG Group's software, libjpeg

In plain English:

1. We don't promise that this software works. (But if you find any bugs, please let us know!)
2. You can use this software for whatever you want. You don't have to pay us.
3. You may not pretend that you wrote this software. If you use it in a program, you must acknowledge somewhere in your documentation that you've used the IJG code.

In legalese:

The authors make NO WARRANTY or representation, either express or implied, with respect to this software, its quality, accuracy, merchantability, or fitness for a particular purpose. This software is provided "AS IS", and you, its user, assume the entire risk as to its quality and accuracy.

This software is copyright © 1991-2009, Thomas G. Lane, Guido Vollbeding.

All Rights Reserved except as specified below.

Permission is hereby granted to use, copy, modify, and distribute this software (or portions thereof) for any purpose, without fee, subject to these conditions:

- (1) If any part of the source code for this software is distributed, then this README file must be included, with this copyright and no-warranty notice unaltered; and any additions, deletions, or changes to the original files must be clearly indicated in accompanying documentation.
- (2) If only executable code is distributed, then the accompanying documentation must state that "this software is based in part on the work of the Independent JPEG Group".
- (3) Permission for use of this software is granted only if the user accepts full responsibility for any undesirable consequences; the authors accept NO LIABILITY for damages of any kind.

These conditions apply to any software derived from or based on the IJG code, not just to the unmodified library. If you use our work, you ought to acknowledge us.

Permission is NOT granted for the use of any IJG author's name or company name in advertising or publicity relating to this software or products derived from it. This software may be referred to only as "the Independent JPEG Group's software".

We specifically permit and encourage the use of this software as the basis of commercial products, provided that all warranty or liability claims are assumed by the product vendor.

ansi2knr.c is included in this distribution by permission of L. Peter Deutsch, sole proprietor of its copyright holder, Aladdin Enterprises of Menlo Park, CA. ansi2knr.c is NOT covered by the above copyright and conditions, but instead by the usual distribution terms of the Free Software Foundation; principally, that you must include source code if you redistribute it. (See the file ansi2knr.c for full details.) However, since ansi2knr.c is not needed as part of any program generated from the IJG code, this does not limit you more than the foregoing paragraphs do.

The Unix configuration script "configure" was produced with GNU Autoconf. It is copyright by the Free Software Foundation but is freely distributable. The same holds for its supporting scripts (config.guess, config.sub, ltmain.sh). Another support script, install-sh, is copyright by X Consortium but is also freely distributable.

The IJG distribution formerly included code to read and write GIF files. To avoid entanglement with the Unisys LZW patent, GIF reading support has been removed altogether, and the GIF writer has been simplified to produce "uncompressed GIFs". This technique does not use the LZW algorithm; the resulting GIF files are larger than usual, but are readable by all standard GIF decoders.

We are required to state that

"The Graphics Interchange Format© is the Copyright property of
CompuServe Incorporated. GIF(sm) is a Service Mark property of
CompuServe Incorporated."

■ About libpng

This copy of the libpng notices is provided for your convenience. In case of any discrepancy between this copy and the notices in the file png.h that is included in the libpng distribution, the latter shall prevail.

COPYRIGHT NOTICE, DISCLAIMER, and LICENSE:

If you modify libpng you may insert additional notices immediately following this sentence. This code is released under the libpng license.

libpng versions 1.2.6, August 15, 2004, through 1.2.47, February 18, 2012, are Copyright © 2004, 2006-2009 Glenn Randers-Pehrson, and are distributed according to the same disclaimer and license as libpng-1.2.5 with the following individual added to the list of Contributing Authors

Cosmin Truta

libpng versions 1.0.7, July 1, 2000, through 1.2.5 - October 3, 2002, are Copyright © 2000-2002 Glenn Randers-Pehrson, and are distributed according to the same disclaimer and license as libpng-1.0.6 with the following individuals added to the list of Contributing Authors

Simon-Pierre Cadieux

Eric S. Raymond

Gilles Vollant

and with the following additions to the disclaimer:

There is no warranty against interference with your enjoyment of the library or against infringement. There is no warranty that our efforts or the library will fulfill any of your particular purposes or needs. This library is provided with all faults, and the entire risk of satisfactory quality, performance, accuracy, and effort is with the user.

libpng versions 0.97, January 1998, through 1.0.6, March 20, 2000, are Copyright © 1998, 1999 Glenn Randers-Pehrson, and are distributed according to the same disclaimer and license as libpng-0.96, with the following individuals added to the list of Contributing Authors:

Tom Lane

Glenn Randers-Pehrson

Willem van Schaik

libpng versions 0.89, June 1996, through 0.96, May 1997, are Copyright © 1996, 1997 Andreas Dilger Distributed according to the same disclaimer and license as libpng-0.88, with the following individuals added to the list of Contributing Authors:

John Bowler

Kevin Bracey

Sam Bushell

Magnus Holmgren

Greg Roelofs

Tom Tanner

libpng versions 0.5, May 1995, through 0.88, January 1996, are Copyright © 1995, 1996 Guy Eric Schalnat, Group 42, Inc.

For the purposes of this copyright and license, "Contributing Authors" is defined as the following set of individuals:

Andreas Dilger
Dave Martindale
Guy Eric Schalnat
Paul Schmidt
Tim Wegner

The PNG Reference Library is supplied "AS IS". The Contributing Authors and Group 42, Inc. disclaim all warranties, expressed or implied, including, without limitation, the warranties of merchantability and of fitness for any purpose. The Contributing Authors and Group 42, Inc. assume no liability for direct, indirect, incidental, special, exemplary, or consequential damages, which may result from the use of the PNG Reference Library, even if advised of the possibility of such damage.

Permission is hereby granted to use, copy, modify, and distribute this source code, or portions hereof, for any purpose, without fee, subject to the following restrictions:

1. The origin of this source code must not be misrepresented.
2. Altered versions must be plainly marked as such and must not be misrepresented as being the original source.
3. This Copyright notice may not be removed or altered from any source or altered source distribution.

The Contributing Authors and Group 42, Inc. specifically permit, without fee, and encourage the use of this source code as a component to supporting the PNG file format in commercial products. If you use this source code in a product, acknowledgment is not required but would be appreciated.

A "png_get_copyright" function is available, for convenient use in "about" boxes and the like:

```
printf("%s",png_get_copyright(NULL));
```

Also, the PNG logo (in PNG format, of course) is supplied in the files "pngbar.png" and "pngbar.jpg (88x31) and "pngnow.png" (98x31).

Libpng is OSI Certified Open Source Software. OSI Certified Open Source is a certification mark of the Open Source Initiative.

Glenn Randers-Pehrson

glennrp at users.sourceforge.net

February 18, 2012

■ About Apple Lossless Audio Codec

Copyright © 2011 Apple Inc. All rights reserved.

Licensed under the Apache License, Version 2.0 (the "License"); you may not use this file except in compliance with the License.

You may obtain a copy of the License at

<http://www.apache.org/licenses/LICENSE-2.0>

Unless required by applicable law or agreed to in writing, software distributed under the License is distributed on an "AS IS" BASIS, WITHOUT WARRANTIES OR CONDITIONS OF ANY KIND, either express or implied.

See the License for the specific language governing permissions and limitations under the License.

■ About FLAC codec library

Copyright © 2000, 2001, 2002, 2003, 2004, 2005, 2006, 2007, 2008, 2009 Josh Coalson

Redistribution and use in source and binary forms, with or without modification, are permitted provided that the following conditions are met:

- Redistributions of source code must retain the above copyright notice, this list of conditions and the following disclaimer.
- Redistributions in binary form must reproduce the above copyright notice, this list of conditions and the following disclaimer in the documentation and/or other materials provided with the distribution.
- Neither the name of the Xiph.org Foundation nor the names of its contributors may be used to endorse or promote products derived from this software without specific prior written permission.

THIS SOFTWARE IS PROVIDED BY THE COPYRIGHT HOLDERS AND CONTRIBUTORS "AS IS" AND ANY EXPRESS OR IMPLIED WARRANTIES, INCLUDING, BUT NOT LIMITED TO, THE IMPLIED WARRANTIES OF MERCHANTABILITY AND FITNESS FOR A PARTICULAR PURPOSE ARE DISCLAIMED. IN NO EVENT SHALL THE FOUNDATION OR CONTRIBUTORS BE LIABLE FOR ANY DIRECT, INDIRECT, INCIDENTAL, SPECIAL, EXEMPLARY, OR CONSEQUENTIAL DAMAGES (INCLUDING, BUT NOT LIMITED TO, PROCUREMENT OF SUBSTITUTE GOODS OR SERVICES; LOSS OF USE, DATA, OR PROFITS; OR BUSINESS INTERRUPTION) HOWEVER CAUSED AND ON ANY THEORY OF LIABILITY, WHETHER IN CONTRACT, STRICT LIABILITY, OR TORT (INCLUDING NEGLIGENCE OR OTHERWISE) ARISING IN ANY WAY OUT OF THE USE OF THIS SOFTWARE, EVEN IF ADVISED OF THE POSSIBILITY OF SUCH DAMAGE.

ПРЕДОСТЕРЕЖЕНИЕ

Использование органов управления или произведение настроек или выполнение процедур, не указанных в данной инструкции, может отразиться на выделении опасной радиации.

CAUTION

Use of controls or adjustments or performance of procedures other than those specified herein may result in hazardous radiation exposure.

LASER Технические характеристики:

Класс 1 LASER продукт
Длина волны: 790 nm (CD)/658 nm (DVD)/405 nm (BD)
Выходная мощность лазера: не более 1 мВт

LASER Specification:

Class 1 LASER Product
Wave length: 790 nm (CDs)/658 nm (DVDs)/405 nm (BDs)
Laser output: max. 1 mW

БЕЗОПАСНОЕ ИСПОЛЬЗОВАНИЕ ЛАЗЕРА

Данное устройство содержит лазер. Из-за опасности травмы глаз, снимать крышку или обслуживать данное устройство должен только сертифицированный обслуживающий персонал.

LASER SAFETY

This unit employs a laser. Due to possible eye injury, only a qualified service person should remove the cover or attempt to service this device.

ОПАСНОСТЬ

Данное устройство в открытом состоянии излучает видимые лазерные лучи. Не допускайте непосредственного воздействия лазерных лучей на глаза. Когда данное устройство подключено к розетке, не приближайте глаза к отверстию лотка диска и другим отверстиям, и не смотрите внутрь аппарата.

DANGER

This unit emits visible laser radiation when open. Avoid direct eye exposure to beam. When this unit is plugged into the wall outlet, do not place your eyes close to the opening of the disc tray and other openings to look into inside.

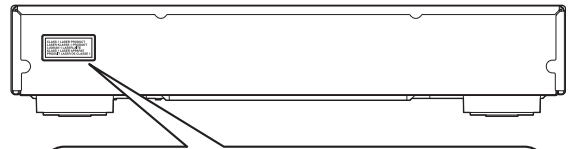

CLASS 1 LASER PRODUCT
LASER KLASSE 1 PRODUKT
LUOKAN 1 LASERLAITE
KLASS 1 LASER APPARAT
PRODUIT LASER DE CLASSE 1

CAUTION: INVISIBLE LASER RADIATION WHEN OPEN.
DO NOT STARE INTO BEAM.
DANGER: INVISIBLE LASER RADIATION WHEN OPEN.
AVOID DIRECT EXPOSURE TO THE BEAM.

