

Canton DM50/50SE, DM75, DM9, DM900

CANTON®

German loudspeaker tradition

www.canton.de

Canton

DM

DM.

80%.

+10+40

5

(,).

(2).

: CR2032.

Canton.

Canton DM.

Canton

40

DM.

DM

Canton.

DM

DM

- 1.
- 2.
- 3.
- 4.
- 5.

()

:1

,1

,1 RCA

DM

Canton DM50, DM75

:

DM50, DM75

40

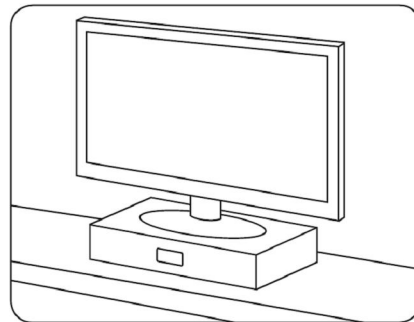

Canton DM9

:

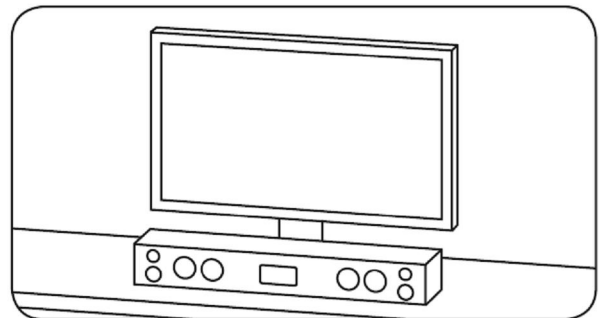
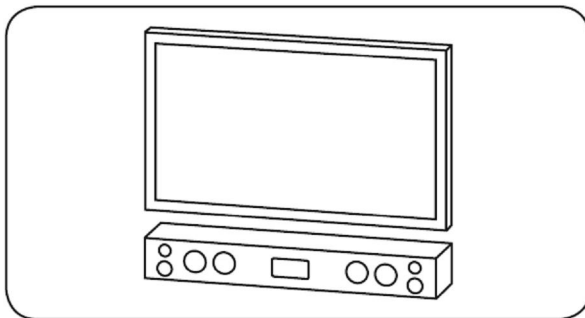

«+», «-».

CR2032.

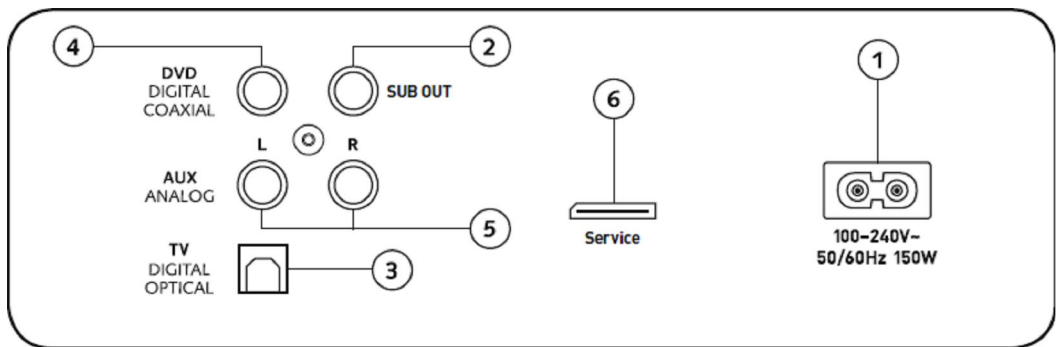

- 1.
- 2.
- 3.
- 4.
- 5.
- 6.

DM

3 (DM ())

(, Blu-Ray DVD)

TV-Digital Input

(Toslink).

DVD-Digital Input (coaxial)

DVD Blu-Ray

(HDMI),
«HDMI » « ».

AUX - Analogue Input

SUB Analogue Output

(. . 8.).

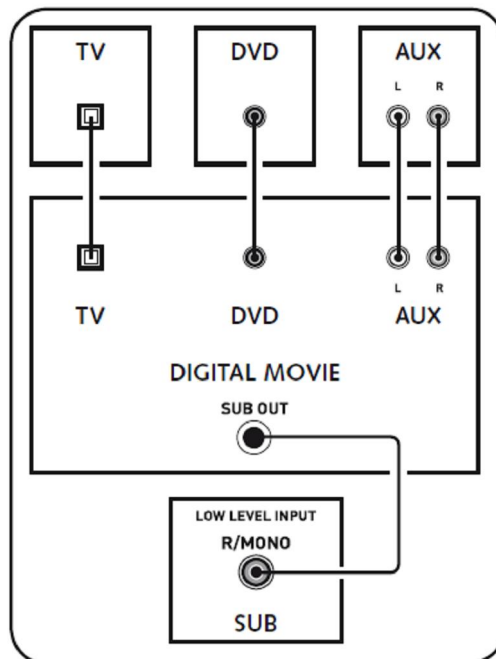

DM

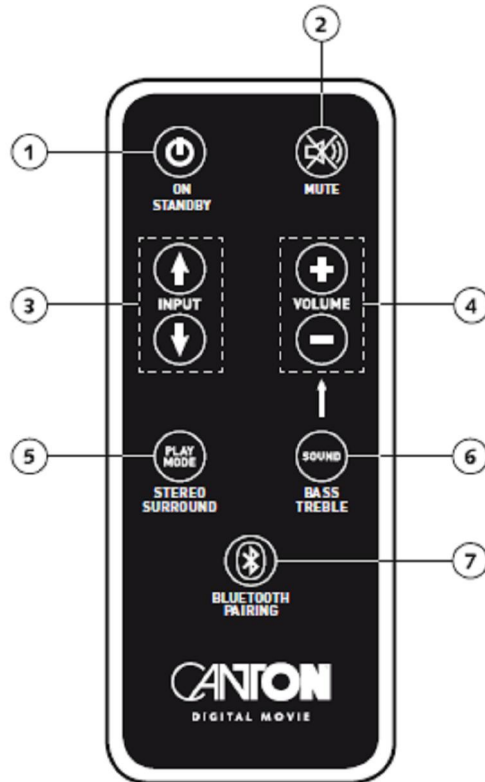

- 1. Power – ()/ ().
- 2. Mute – .
- 3. INPUT – .
- 4. .
- 5. Play Mode – /Surround ().
- 6. Sound – (,).
- 7. Bluetooth pairing – Bluetooth.

Bluetooth

: Bluetooth 2.0. Bluetooth. (10).

BT . Bluetooth 30 , Bluetooth BTP.

DM

CON.

FBI.

: DM

3 Bluetooth

: 0000



BT



BTP



- Canton DM 50 -



CON

FBI

5

Input

TV

TV Input (optical)

DVD

DVD Input (coaxial)

AUX

AUX input (analogue)

BT

Bluetooth

Soundmode

V30

Volume (0-99)

MUT

Mute

B+6

Bass level (+/-6)

T+6

Treble level (+/-6)

Playmode

ST

Stereo

SUR

Surround

Bluetooth

BTP

CON

DIS

FBI

BT,

10 .

LIP. SOUND Volume +/- 3 .

Volume +/- SOUND SUB.

Volume +/- 80 .

Volume +/- (), EQ2 3 SOUND : EQ1 EQ. (DM9, EQ.) EQ3

Volume +/- (Dolby Laboratories). SOUND DRC.

3- SOUND

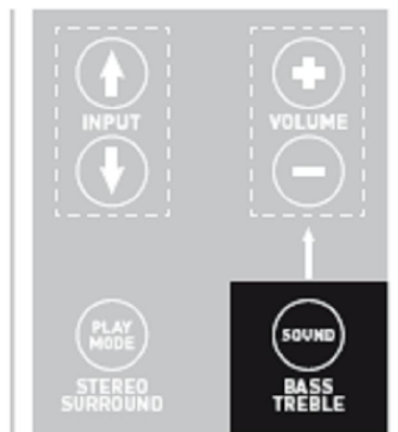
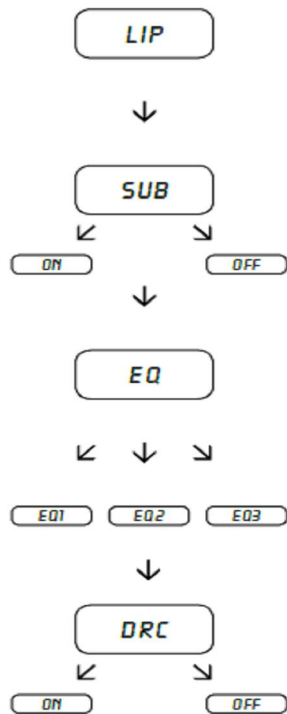

- 1.
- 2.
- 3.
- 4.
- 5.
- 6.
- 7.
- 8.
- 9.
- 10.
- 11.

Standby IRL 5
 () Volume+
 V+ (Volume+),
 20
 Ok.
 (FAI 5.)
 Standby 5 4.
 60

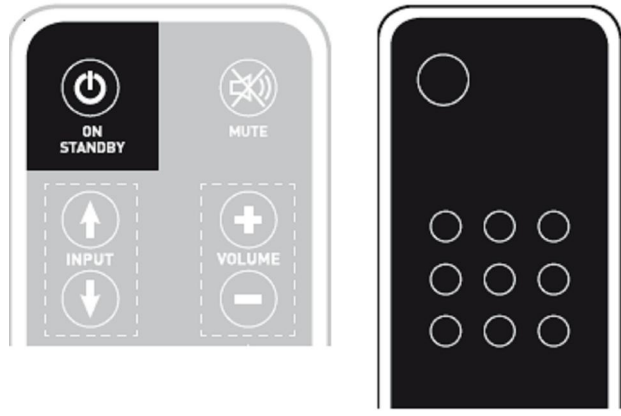

On/Standby

DM

STB

ON

- 1.
- 2.
- 3.
- 4.
- 5.

Standby IRL 5
 «Mute» IRL 5
 LR 5

- 30
- Opt / Coax () ON/OFF (AUT)
- DM «Play Mode» 3
 - "Volume -" AUT. "Volume +" (ON)
 - () (OFF). 3 "Play Mode".
- (Standby)

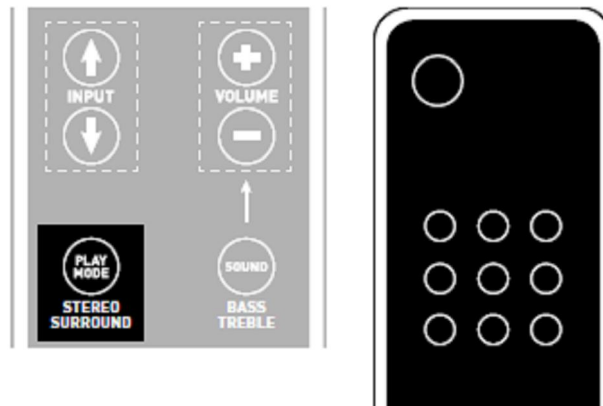

- ECO (ECO Standby)
- ECO. 1 «Play Mode» 3
 - DM AUT. "Play Mode"
 - ECO. "Volume +" (ON)
 - "Volume -" (OFF). 3 "Play Mode".

- BT (SEL).
- (Bluetooth) (MAN), (AUT), BT
1. DM , AUT. «Play Mode» 3
 2. SEL. "Play Mode"
 3. "Volume -" (MAN). "Volume +" (AUT) 3 "Play Mode".

DM50/ DM50SE:

- 3-

: 200

: 40-23.000

: Dolby Digital, DTS.

: 2 10

: 2 5

: 2 1,9

(): 54,5 6,5 30

: 5,3 / 6.5

: 1 , 1 , 1

DM75:

- 3-

: 200

: 35-23.000

: Dolby Digital, DTS.

: 4 10

: 2 5

: 2 1,9

(): 72,5 6,95 32

: 7,75

: 1 , 1 , 1

DM9:

- 3-

: 200 .

: 40-23.000

: Dolby Digital, DTS.

: 4 10 . (2 , 2)

: 2 5 .

: 2 1,9 .

(): 89 12 7 .

: 5,3 .

: 1 , 1 , 1 .

: . Weilrod, D-61276, Neugasse 21-23, Canton Elektronik GmbH +Co.

:

Meiloon Acoustic Equipment Co., Ltd. , , 523727, .

5 .

