

# JBL® FLIP

## OWNER'S MANUAL

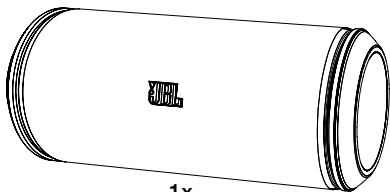

1x

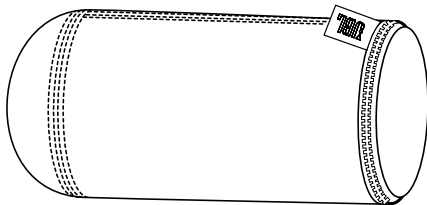

1x

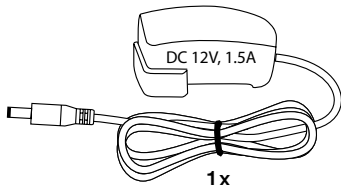

1x

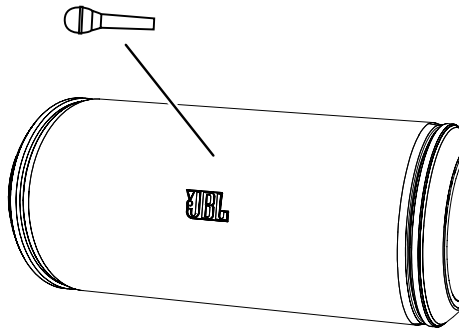
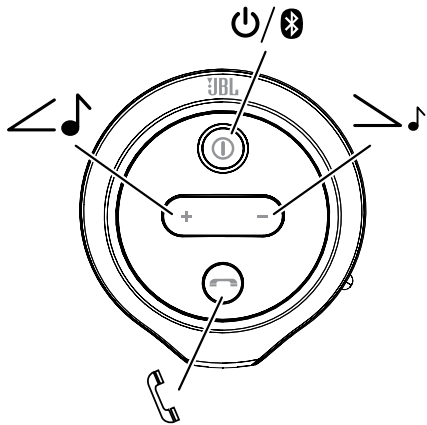

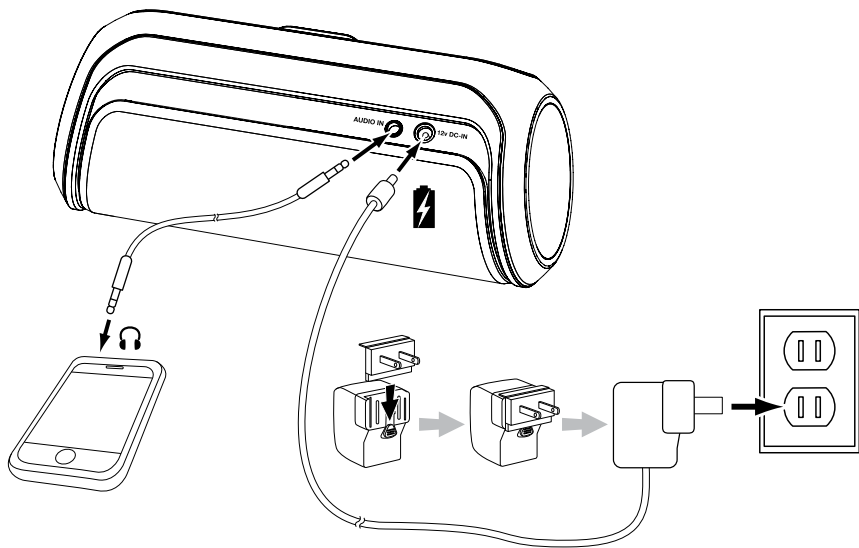



1.

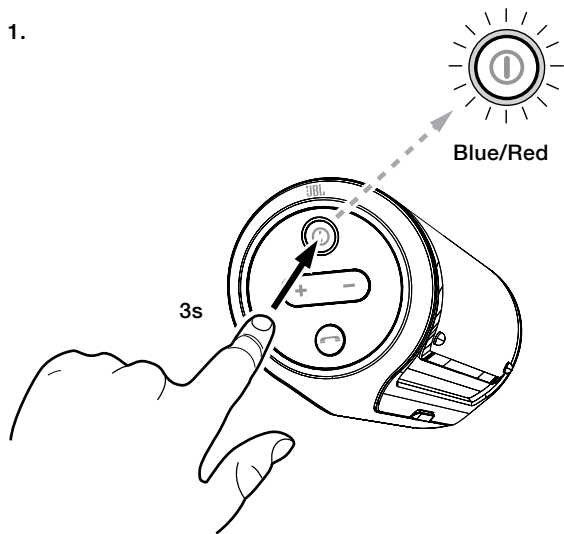

2.

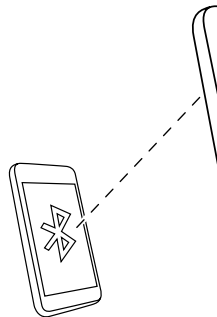

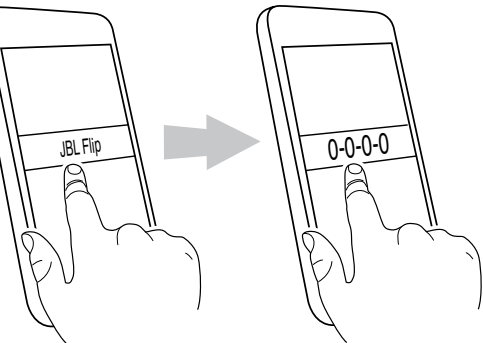



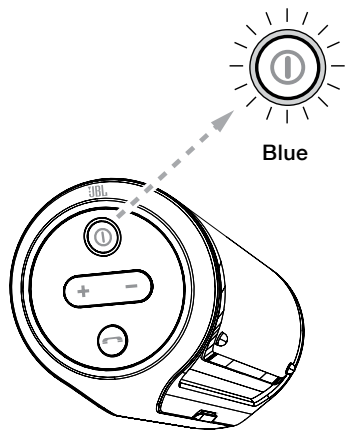

3.





## PHONE BUTTON OPERATION

		
CONDITION	SHORT PRESS	LONG PRESS
No Call	N/A	Enter Voice Recognition Mode
Dialing Outgoing Calls	Hang Up	Hang Up
Incoming Call #1	Answer Call	Reject Call
During Call	Hang Up	Switch Call from Flip to Phone
Incoming Call #2	Put Call #1 on Hold: Answer Call #2	Reject Call #2
Calls #1 and #2 Both Active	Hang Up Current Call; Switch to Other Call	Switch Between Call #1 and Call #2

## UTILISATION DES TOUCHES DU TÉLÉPHONE

		
CONDITION	APPUI BREF	APPUI LONG
Aucun appel	N/A	Entrer en mode Reconnaissance vocale
Numérotation appels sortants	Raccrocher	Raccrocher
Appel entrant 1	Répondre à l'appel	Rejeter l'appel
Durant l'appel	Raccrocher	Basculer l'appel du Flip au téléphone
Appel entrant 2	Mettre l'appel 1 en attente : répondre à l'appel 2	Rejeter l'appel 2
Appels 1 et 2 tous deux actifs	Raccrocher l'appel en cours ; passer à l'autre appel	Basculer entre les appels 1 et 2

## GUIA DE OPERACION DEL BOTON TELEFONICO

		
ESTADO	TOQUE CORTO	TOQUE LARGO
No Llamada	No Aplica	Entrar a modo de reconocimiento de voz
Marcar Llamadas de Salida	Colgar	Colgar
Llamada de entrada #1	Contestar Llamada	Rechazar Llamada
Durante una llamada	Colgar	Cambiar Llamada del Flip al Telefono
Llamada de entrada #2	Poner Llamada #1 en espera; Contestar llamada #2	Rechazar Llamada #2
Llamada #1 y #2 Activas al mismo tiempo	Colgar Llamada en progreso; Cambiar a otra Llamada	Cambiar entre llamada #1 Y Llamada #2

## USO DO BOTÃO TELEFÔNICO

		
ESTADO	TOQUE CURTO	TOQUE LONGO
Sem Chamadas	N/D	Ativar Reconhecimento de Voz
Efetuando Chamadas	Desligar	Desligar
Recebendo Chamada 1	Atender Chamada	Rejeitar Chamada
Durante Chamada	Desligar	Trocar Chamada do Flip para Telefone
Recebendo Chamada 2	Chamada 1 em Espera: Atender Chamada 2	Rejeitar Chamada 2
Chamadas 1 e 2 Activas	Desligar Chamada Atual; Trocar para a Outra	Trocar entre Chamadas 1 e 2

## TELEFONTASTENBEDIENUNG



**KURZES  
DRÜCKEN**



**LANGES  
DRÜCKEN**

MODUS	KURZES DRÜCKEN	LANGES DRÜCKEN
Kein Anruf	Nicht belegt	Spracherkennungsmodus starten
Wählen von Telefonnummern	Auflegen	Auflegen
Eingehender Anruf #1	Anruf annehmen	Anruf ablehnen
Während des Gesprächs	Auflegen	Von Flip auf Telefon umschalten
Eingehender Anruf #2	Gespräch #1 auf Halten umschalten; Anruf #2 annehmen	Anruf #2 ablehnen
Anrufe #1 und #2 beide aktiv	Gespräch beenden; auf anderes Gespräch umschalten	Umschalten zwischen Gespräch #1 und #2

## OPERAZIONI MEDIANTE PULSANTE TELEFONO



**PRESSIONE  
BREVE**



**PRESSIONE  
PROLUNGATA**

CONDIZIONE	PRESSIONE BREVE	PRESSIONE PROLUNGATA
Nessuna chiamata	Non applicabile	Modalità riconoscimento vocale
Chiamate in uscita	Riagganciare	Riagganciare
Chiamata in entrata n. 1	Rispondere alla chiamata	Rifiutare la chiamata
Durante la chiamata	Riagganciare	Passare chiamata da Flip a telefono
Chiamata in entrata n. 2	Chiamata n.1 in attesa per rispondere alla chiamata n. 2	Rifiutare la chiamata n. 2
Chiamate n. 1 e 2 entrambe attive	Terminare la chiamata in corso e passare all'altra	Passare dalla chiamata n. 1 a quella n. 2



## 電話ボタンの操作

条件	 短く押す	 長く押す
電話がかかって来ていない	該当無し	音声認識モードに入る
ダイヤルして電話をかける	通話を終了する	通話を終了する
一番目の着信	電話に出る	電話を拒否する
通話中	通話を終了する	通話をFlipから電話に切り替える
二番目の着信	一番目の電話を保留にし、二番目の電話に出る	二番目の電話を拒否する
一番目と二番目の電話が両方とも繋がっている	現在の通話を終了し、別の電話に切り替える	一番目と二番目の電話を切り替える

## 전화 버튼 작동

상태	 짧게 누르기	 길게 누르기
전화 없음	사용 불가	음성 인식모드 입력
전화 걸기	전화 끊기	전화 끊기
1번 전화	전화 받기	수신 거부
전화 중	전화 끊기	Flip에서 전화기로 통화 전환
2번 전화	1번 전화통화대기: 2번 전화 받기	2번 수신 거부
1번, 2번 전화 모두 통화 상태	현재 전화끊기: 다른 전화로 통화 전환	1번, 2번 전화 사이에서 통화 전환



## 电话按键操作

状态	 短按	 长按
无来电	N/A	输入语音识别模式
正在拨出电话	挂断	挂断
来电#1	接听来电	拒绝来电
通话期间	挂断	将来电从Flip切换至手机
来电#2	保持来电#1: 接听来电#2	拒绝来电#2
来电#1和#2均在通话	挂断当前通话; 切换至其他通话	在来电#1和来电#2之间切换



## 電話按鍵操作

狀態	 短按	 長按
無來電	N/A	輸入語音識別模式
正在撥出電話	掛斷	掛斷
來電#1	接聽來電	拒絕來電
通話期間	掛斷	將來電從Flip切換至手機
來電#2	保持來電#1: 接聽來電#2	拒絕來電#2
來電#1和#2均在通話	掛斷當前通話; 切換至其他通話	在來電#1和來電#2之間切換

## BEDIENING VAN DE TELEFOONTOETS

		
SITUATIE	KORT INDRUKKEN	LANG INDRUKKEN
Geen oproep	n.v.t.	Naar stemherkenningsmodus
Nummer bellen	Oproep beëindigen	Oproep beëindigen
Inkomende oproep 1	Oproep aannemen	Oproep weigeren
Tijdens oproep	Oproep beëindigen	Oproep van Flip naar telefoon
Inkomende oproep 2	Oproep 1 in wachtstand: Oproep 2 aannemen	Oproep 2 weigeren
Oproep 1 en 2 beiden actief	Stop huidige oproep; Naar andere oproep	Schakel tussen oproep 1 en oproep 2

## BRUK AV TELEFONKNAPPEN

		
TILSTAND	KORT TRYKK	LANGT TRYKK
Ingen samtale	N/A	Gå inn i stemmegjenkenningsmodus
Tasting av utgående samtaler	Legg på	Legg på
Innkommende samtale #1	Svar på samtalen	Avvis samtalen
Under samtale	Legg på	Bytt samtale fra Flip til telefon
Innkommende samtale #2	Plasser samtale #1 på vent: Svar samtale #2	Avvis samtale #2
Samtale #1 og #2 er begge aktive	Legg på den gjeldende samtalen; bytt til den andre samtalen	Bytt mellom samtale #1 og samtale #2



## PUHELIMEN NÄPPÄINTEN KÄYTTÖ

		
TILA	LYHYT PAINALLUS	PITKÄ PAINALLUS
Ei puhelua	N/A	Siirry äänentallennustilaan
Lähtevää puhelua näppäilyssä	Lopeta	Lopeta
Saapuva puhelu #1	Vastaa puheluun	Hylkää puhelu
Puhelun aikana	Lopeta	Siirrä puhelu Flipistä puhelimeen
Saapuva puhelu #2	Laita puhelu #1 pitoon ja vastaa puheluun #2	Hylkää puhelu #2
Puhelut #1 ja #2 aktiivisia	Lopeta nykyinen puhelu ja vaihda toiseen puheluun	Vaihtelee puhelujen #1 ja #2 välillä



## Функции кнопки телефона

		
УСЛОВИЕ	КОРОТКОЕ НАЖАТИЕ	ДЛИННОЕ НАЖАТИЕ
Нет звонка	нет	Вкл. режим распознавания голоса
Набор исходящего вызова	Отбой	Отбой
Входящий звонок 1	Ответить	Сбросить
Во время звонка	Отбой	Переключить звонок с устройства на телефон
Входящий звонок 2	Перевести звонок 1 в режим ожидания; ответить на звонок 2	Сбросить звонок 2
Оба звонка (1 и 2) активны	Завершить текущий звонок; переключиться на другой звонок	Переключиться между звонком 1 и звонком 2

## KNAPPFUNKTIONER SIDA 6

		
VILLKOR	KORT TRYCK	LÅNGT TRYCK
Inget samtal	Ej tillämpl.	Gå till röstigen-känningsläge
Ringer utgående samtal	Lägg på	Lägg på
Inkommande samtal #1	Svara på samtal	Svara inte på samtal
Under samtal	Lägg på	Växla samtal från Flip till telefon
Inkommande samtal #2	Placera samtal #1 i kö: Svara på samtal #2	Svara inte på samtal #2
Både samtal #1 och samtal #2 är aktiva	Lägg på pågående samtal; Byt till annat samtal	Växla mellan samtal #1 och samtal #2

## BETJENING AF TELEFONKNAPPER

		
TILSTAND	KORT TRYK	LANGT TRYK
Intet opkald	Ikke tilgængeligt	Aktivér Stemmegenkendelse
Taster Udgående opkald	Læg på	Læg på
Indgående opkald nr. 1	Svar	Afvis
Under opkald	Læg på	Skift opkald fra flip til telefon
Indgående opkald nr. 2	Sæt opkald 1 i kø	Afvis opkald 2
Opkald 1 og 2 er begge aktive	Læg aktuelle på, skift til andet opkald	Skift mellem opkald 1 og 2

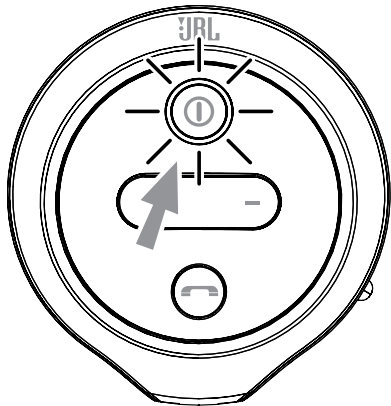

Blue = 

Red = 

Blue/Red (flashing) = 

 Blue	 Red	 Blue/Red (flashing)
Bleu	Rouge	Bleu (clignotant)
Azul	Rojo	Azul (intermitente)
Azul	Vermelha	Azul (piscando)
Blau	Rot	Blau (blinken)
Blu	Rosso	Blu (lampeggiante)
Blauw	Rood	Blauw (knippen)
Blå	Rød	Blå (blinkende)
Sininen	Punainen	Sininen (vilkkuu)
Blått	Rött	Blått (blinkande)
Blå	Rød	Blå (blinkende)
Синий	Красный	Синий (мигающий)
青	赤	青 (点滅する)
藍色	紅色	藍色／紅色 (閃爍)
蓝色	红色	蓝色 (閃爍)
파란색	빨간색	파란색 (점멸)

## SPECIFICATIONS

---

Transducers: 2 x 1-1/2" (38mm)

---

Amplifier power: 2 x 5W

---

Frequency response: 150Hz – 20kHz

---

Signal-to-noise ratio: >80dB

---

Battery type: Li-ion rechargeable  
7.4V, 1000mAh

---

*Bluetooth* transmitter  
frequency range: 2.402 – 2.480GHz

---

*Bluetooth* transmitter  
power: 0 ~ 20dBm

---

*Bluetooth* transmitter  
modulation: GFSK

---

Listening time on battery  
power: >5 hours

---

Battery charge time: 3 hours

---

Dimensions (Dia x H): 63mm x 160mm  
(2-7/16" x 6-5/16")

---

## SPECIFICATIONS

---

Transducteurs : 2 x 1-1/2 po (38mm)

---

Puissance d'amplificateur : 2 x 5W

---

Courbe de résonance : 150Hz – 20kHz

---

Rapport signal sur bruit : >80dB

---

Type de batterie : Li-ion rechargeable  
7.4V, 1000mAh

---

Plage de fréquence de  
l'émetteur *Bluetooth* : 2.402 – 2.480GHz

---

Puissance de l'émetteur  
*Bluetooth* : 0 ~ 20dBm

---

Modulation de l'émetteur  
*Bluetooth* : GFSK

---

Autonomie d'écoute : > 5 heures

---

Durée de charge : 3 heure

---

Dimensions (Dia x H) : 63mm x 160mm  
(2-7/16 po x 6-5/16 po)

---

## ESPECIFICACIONES

---

Transductores: 2 x 1-1/2" (38mm)

---

Potencia de amplificador: 2 x 5W

---

Respuesta en frecuencia: 150Hz – 20kHz

---

Relación señal/ruido: >80dB

---

Tipo de pila: Litio-ion recargable  
7.4V, 1000mAh

---

Rango de frecuencia del  
transmisor *Bluetooth*: 2.402 – 2.480GHz

---

Potencia del transmisor  
*Bluetooth*: 0 ~ 20dBm

---

Modulación del transmisor  
*Bluetooth*: GFSK

---

Tiempo de escucha a pilas: >5 horas

---

Tiempo de carga de la pila: 3 horas

---

Dimensiones  
(Diámetro x Altura): 63mm x 160mm (2-  
7/16" x 6-5/16")

---

## ESPECIFICAÇÕES

---

Transdutores: 2 x 1-1/2" (38mm)

---

Potência do amplificador: 2 x 5W

---

Resposta de frequência: 150Hz – 20kHz

---

Relação sinal/ruído: >80dB

---

Tipo da bateria: Íon-lítio recarregável  
7.4V, 1000mAh

---

Intervalo de frecuencia do  
transmissor *Bluetooth*: 2.402 – 2.480GHz

---

Potencia do transmissor  
*Bluetooth*: 0 ~ 20dBm

---

Modulação do transmissor  
*Bluetooth*: GFSK

---

Tempo de reprodução com  
energia da bateria: >5 horas

---

Tempo de carga da bateria: 32 horas

---

Dimensões (Diâm. x A): 63mm x 160mm  
(2-7/16" x 6-5/16")

---



## SPEZIFIKATIONEN

---

Wandler: 2 x 38mm

---

Verstärkerleistung: 2 x 5W

---

Frequenzgang: 150Hz – 20kHz

---

Signal-Rausch-Verhältnis: >80dB

---

Batterietyp: Li-ion wiederaufladbare  
7.4V, 1000mAh

---

*Bluetooth*-  
Sendefrequenzbereich: 2.402 – 2.480GHz

---

*Bluetooth*-Sendeleistung: 0 ~ 20dBm

---

*Bluetooth*-  
Sendemodulation: GFSK

---

Hörstunden bei  
Batteriebetrieb: >5 Stunden

---

Batterieladezeit: 3 Stunden

---

Abmessungen  
(Durchm. x H): 63mm x 160mm

---

## SPECIFICHE

---

Trasduttori: 2 x 1-1/2" (38mm)

---

Potenza amplificatore: 2 x 5W

---

Risposta in frequenza: 150Hz – 20kHz

---

Rapporto segnale-rumore: >80dB

---

Tipo batteria: Ioni di litio ricaricabile  
7.4V, 1000mAh

---

Intervallo di frequenza  
trasmettitore *Bluetooth*: 2.402 – 2.480GHz

---

Alimentazione trasmettitore  
*Bluetooth*: 0 ~ 20dBm

---

Modulazione trasmettitore  
*Bluetooth*: GFSK

---

Tempo di ascolto con  
batteria: >5 ore

---

Tempo di ricarica della  
batteria: 3 ore

---

Dimensioni (diam x A): 63mm x 160mm  
(2-7/16 po x 6-5/16 po)

---

<b>仕様</b>	
トランスデューサー:	38mm 2個
アンプ出力:	2 x 5W
周波数応答:	150Hz - 20kHz
信号対雑音比 (SN比):	80dB未滿
電池タイプ:	リチウムイオン再充電可能な 7.4V, 1000mAh
<i>Bluetooth</i> トランスミッターの 周波数帯域:	2.402 - 2.480GHz
<i>Bluetooth</i> トランスミッター の電源:	0 - 20dBm
<i>Bluetooth</i> トランスミッターの 変調方式:	GFSK
電池使用時の可聴時間:	5時間超
電池充電時間:	3時間
寸法 (直径×高さ):	63mm x 160mm (6-5/16インチ× 6-5/16インチ)

<b> 사양</b>	
트렌스듀서:	38mm 2개
앰프 출력:	2 x 5W
주파수 응답 대역:	150Hz ~ 20kHz
신호대 잡음 비율:	80dB 이상
배터리 타입:	리튬-이온 충전식 7.4V, 1000mAh
<i>블루투스</i> 송수신기 주파수 대역:	2.402 - 2.480GHz
<i>블루투스</i> 송수신기 전원:	0 ~ 20dBm
<i>블루투스</i> 송수신기 변조:	GFSK
배터리 사용시간:	보다 큰 5시간
배터리 충전시간:	3 시간
규격(직경 x 높이):	63mm x 160mm (2-7/16" x 6-5/16")

## 规格

变频器: 2 x 1-1/2" (38mm)

放大器功率: 2 x 5W

频率响应: 150Hz – 20kHz

信噪比: >80dB

电池类型: 锂离子充电  
7.4V, 1000mAh

*Bluetooth* 蓝牙发射机频率范围: 2.402 - 2.480GHz

*Bluetooth* 蓝牙发射机功率: 0 - 20dBm

*Bluetooth* 蓝牙传输器调制: GFSK

电池电量收听时间: >5 小时

电池充电时间: 3 小时

尺寸 (直径 x 高): 63mm x 160mm  
(2-7/16" x 6-5/16")

## 规格

变频器: 2 x 1-1/2" (38mm)

放大器功率: 2 x 5W

频率響應: 150Hz – 20kHz

信噪比: >80dB

電池類型: 鋰離子充電  
7.4V, 1000mAh

藍牙送話器頻率範圍: 2.402 – 2.480GHz

藍牙送話器功率: 0 ~ 20dBm

藍牙送話器調製: GFSK

電池電量通話時間: > 5小時

電池充電時間: 3小時

尺寸 (直徑x高): 63mm x 160mm  
(2-7/16" x 6-5/16")

## SPECIFICATIES

---

Omvormers:	2 x 38mm
Versterkervermogen:	2 x 5W
Frequentieweergave:	150Hz – 20kHz
Signaal-ruisverhouding:	>80dB
Type batterij:	Li-ion oplaadbare 7.4V, 1000mAh
<i>Bluetooth</i> zender frequentiebereik:	2.402 – 2.480GHz
Vermogen van de <i>Bluetooth</i> zender:	0 ~ 20dBm
<i>Bluetooth</i> zendermodulatie:	GFSK
Luistertijd voor batterij:	>5 uur
Oplaadtijd voor batterij:	3 uur
Afmetingen (Diameter x Hoogte):	63mm x 160mm

## SPESIFIKASJONER

---

Omformere:	2 x 1-1/2" (38mm)
Forsterkereffekt:	2 x 5W
Frekvensrespons:	150Hz – 20kHz
Signal-til-støy-forhold:	>80dB
Batteritype:	Li-ion genopladelige 7.4V, 1000mAh
<i>Bluetooth</i> -senders frekvensomrade:	2.402 – 2.480GHz
<i>Bluetooth</i> -senders effekt:	0 ~ 20dBm
<i>Bluetooth</i> -senders effekt:	GFSK
Lyttetid på batteristrøm:	>5 timer
Batteriladetid:	3 time
Dimensjoner (D x H):	63mm x 160mm (2-7/16" x 6-5/16")

## TEKNISET TIEDOT

---

Anturit: 2 x 1-1/2" (38mm)

---

Vahvistinteho: 2 x 5W

---

Taajuusvaste: 150Hz – 20kHz

---

Äänentoisto: >80dB

---

Paristo: Li-ion  
7.4V, 1000mAh

---

*Bluetooth*-lahettimen  
taajuusalue: 2.402 – 2.480GHz

---

*Bluetooth*-lahettimen teho: 0 ~ 20dBm

---

*Bluetooth*-lahettimen  
modulaatio: GFSK

---

Kuuntelu-aika  
paristokäytöllä: > 5 tuntia

---

Pariston latausaika: 3 tuntia

---

Mitat (Halk. x K): 63mm x 160mm  
(2-7/16 tuumaa x  
6-5/16 tuumaa)

---

## ТЕХНИЧЕСКИЕ ХАРАКТЕРИСТИКИ

---

Динамики: 2 x 1-1/2" (38mm)

---

Мощность усилителя: 2 x 5Вт

---

Частотная характеристика: 150Гц – 20кГц

---

Отношение сигнал/шум: >80дБ

---

Тип аккумулятора: Литий-ионный  
перезаряжаемый  
7.4V, 1000mAh

---

Диапазон частот передатчика  
*Bluetooth*: 2.402 – 2.480GHz

---

Мощность передатчика  
*Bluetooth*: 0 – 20dBm

---

Модуляция передатчика  
*Bluetooth*: GFSK

---

Время звучания от  
аккумулятора: >5 часов

---

Время зарядки аккумулятора: 3 часа

---

Размеры (Диаметр x В): 63mm x 160mm  
(2-7/16" x 6-5/16")

---

## SPECIFIKATIONER

---

Omvandlare:	2 x 38mm
Förstärkareffekt:	2 x 5W
Frekvensåtergivning:	150Hz – 20kHz
Signalbrusförhållande:	>80dB
Batterityp:	Litiumjon 7.4V, 1000mAh
<i>Bluetooth</i> -sandarens frekvensområde:	2.402 – 2.480GHz
<i>Bluetooth</i> -sandareffekt:	0 ~ 20dBm
<i>Bluetooth</i> -sandarmodulering:	GFSK
Lyssningstid med batteri:	> 5 timmar
Batteriladdningstid:	3 timmar
Mått (diameter x höjd):	63mm x 160mm

## SPECIFIKATIONER

---

Transducere:	2 x 1-1/2" (38mm)
Forstærkerstrøm:	2 x 5W
Frekvenssvar:	150Hz – 20kHz
Signal-til-støj-forhold:	>80dB
Batteri-type:	Li-ion opladbart 7.4V, 1000mAh
<i>Bluetooth</i> -sender:	2.402 – 2.480GHz
<i>Bluetooth</i> -sendereffekt:	0 ~ 20dBm
<i>Bluetooth</i> -sendermodulation:	GFSK
Lyttetid på batteristrøm:	> 5 timer
Batteri-opladetid:	3 time
Dimensioner (Dia. x H):	63mm x 160mm (2-7/16 tommer x 6-5/16 tommer)



**HARMAN**

HARMAN International Industries, Incorporated  
8500 Balboa Boulevard, Northridge,  
CA 91329 USA  
[www.jbl.com](http://www.jbl.com)

© 2012 HARMAN International Industries, Incorporated. All rights reserved.  
JBL is a trademark of HARMAN International Industries, Incorporated,  
registered in the United States and/or other countries. The *Bluetooth* word  
mark and logos are owned by the *Bluetooth* SIG, Inc. and any use of such  
marks by HARMAN International Industries, Incorporated is under license.

Features, specifications and appearance are subject to change without notice.

Part #: 950-0474-001 Rev. A