

ROWENTA

FITSPA

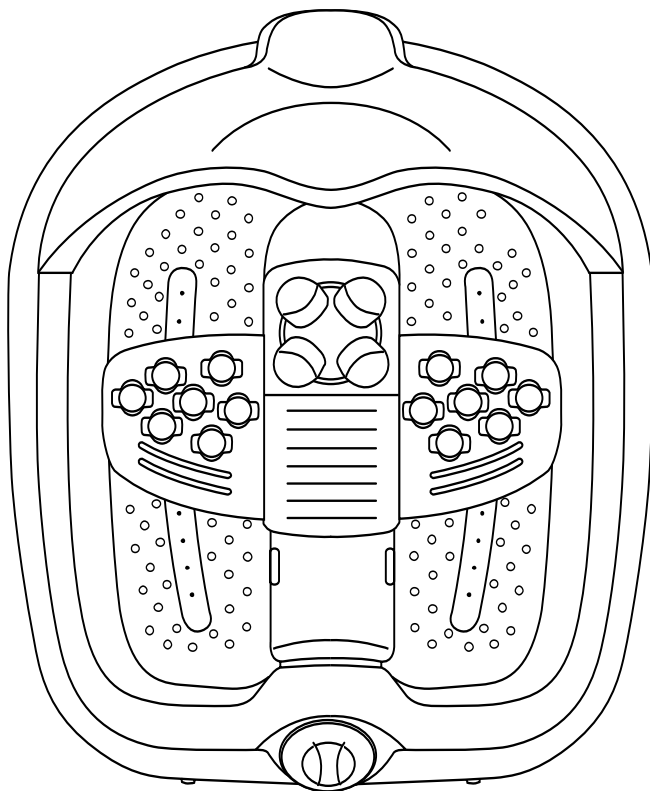

Gebrauchsanweisung

Notice d'emploi

Istruzioni per l'uso

Modo de empleo

Modo de utilização

Kullanım kılavuzu

Használati utasítás

Instrukcja obsługi

Инструкция по использованию

Návod k použitiu

Návod k použití

Navodilo za uporabo

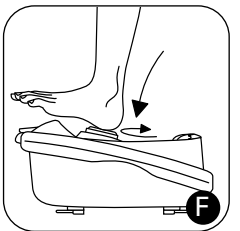
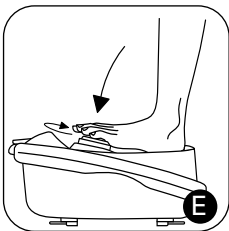
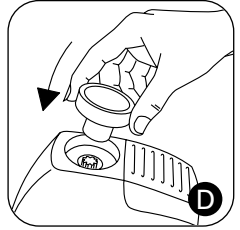
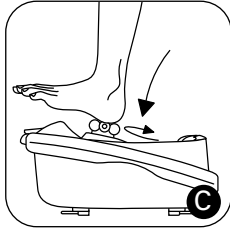
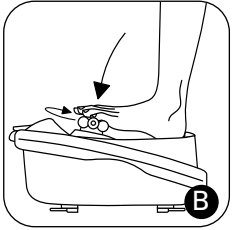
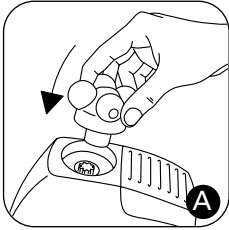
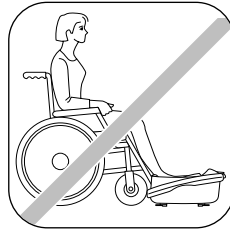
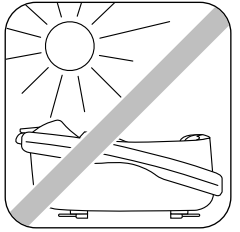
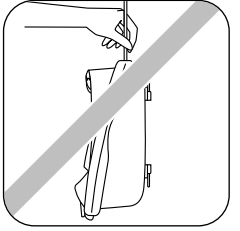
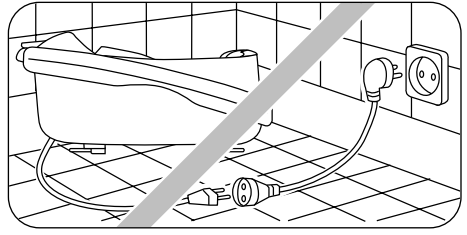
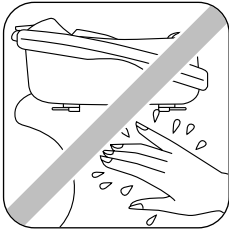

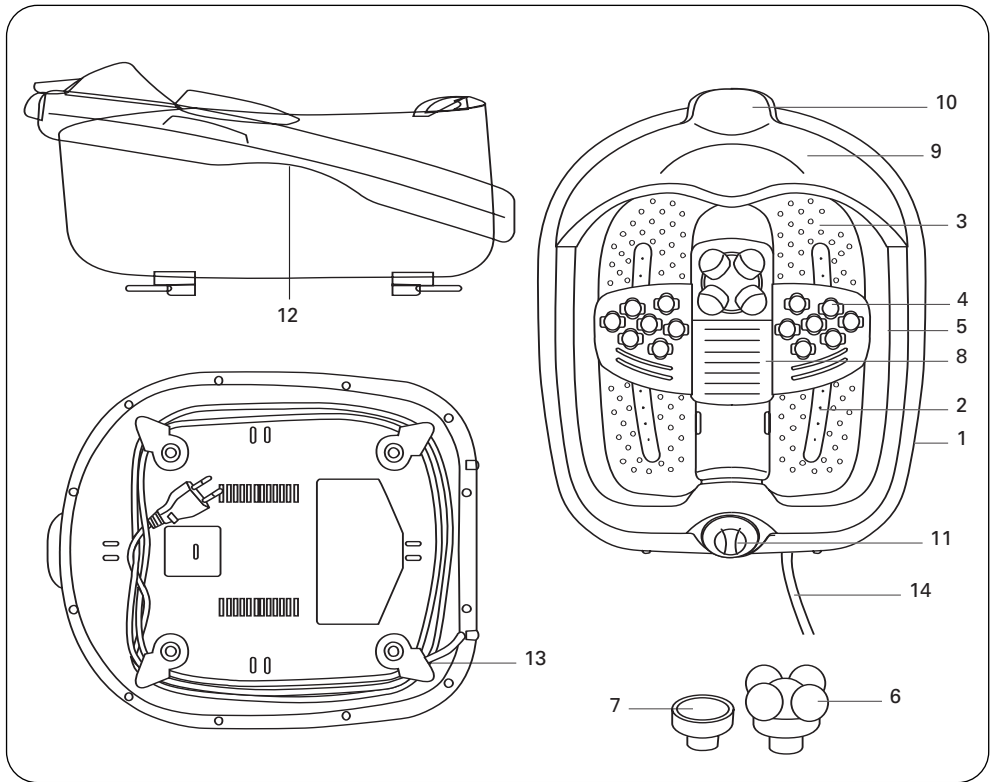

D EIGENSCHAFTEN

1. Wanne
2. Blasendiffusor
3. Kugelteppich
4. Massagekugeln
5. Maximaler Wasserstand

6. Zubehör für Reflexzonenmassage
7. Zubehör für Peeling
8. Deckel "Fußablage"
9. Schutzschirm "Fußablage"
10. Ausgießer
11. Wahlschalter

12. Tragegriffe
13. Füße zum Aufrollen des Kabels
14. Netzanschlusskabel

F CARACTERISTIQUES

1. Cuve
2. Diffuseur de bulles
3. Tapis de billes
4. Billes de massage

5. Niveau d'eau maximum
6. Accessoire de réflexologie
7. Accessoire de gommage
8. Couvercle « repose pieds »
9. Casquette « repose pieds »
10. Bec verseur

11. Sélecteur
12. Poignées de transport
13. Pieds enrouleurs de cordon
14. Cordon d'alimentation

I CARATTERISTICHE

1. Vasca
2. Diffusore di bolle
3. Tappetino a sfera
4. Sfere per il massaggio

5. Livello massimo d'acqua
6. Accessorio di riflessologia
7. Accessorio di "peeling"
8. Coperchio "appoggiapiedi"
9. Berretto "appoggiapiedi"

10. Beccuccio versatore
11. Selettore
12. Maniglie di trasporto
13. Piedi avvolgitori di cordone
14. Cordone d'alimentazione

E CHARACTERÍSTICAS

1. Cuba
2. Difusor de burbujas
3. Tapiz de bolas
4. Bolas de masaje

5. Nivel máximo de agua
6. Accesorios de reflexología
7. Accesorio de exfoliación
8. Tapa "reposa pies"
9. Casquete reposa pies
10. Pico vertedor

11. Selector
12. Asas de transporte
13. Pies para enrollar el cordón
14. Cordón de suministro eléctrico

P CARACTERÍSTICAS

1. Cuba
2. Difusor de bolhas
3. Tapete de esferas
4. Esferas de massagem

5. Nível de água máximo
6. Acessório de reflexologia
7. Acessório de exfoliação
8. Tampa " repousa-pés"
9. Cobertura "repousa-pés"

10. Bico para verter
11. Selector
12. Pegas de transporte
13. Apoios enroladores de fio
14. Cabo de alimentação

T ÖZELLİKLERİ

1. Tekne
2. Kabarcık çıkarıcı
3. Bilya düzlemi
4. Masaj bilyaları
5. Azamî su seviyesi

6. Refleks aksesuarı
7. Sertleşmiş kısımları giderme aksesuarı
8. "Ayak koyma" kapağı
9. "Ayak koyma" kasketi

10. Dökme ağız
11. Seçme düğmesi
12. Taşıma kulpu
13. Kablo sarma ayakları
14. Kablo

PL JELLEMLŐK

1. Tál
2. Buborékelosztó
3. Golyós alátét
4. Masszírozógolyók
5. Maximális vízszint

6. Reflexológiai tartozék
7. Dörzslap
8. Lábtartó fedél
9. Lábtartó burkolat
10. Kiöntőcső

11. Választókapcsoló
12. Fogantyú
13. Lábak amelyekre a kábel felcsavarható
14. Hálózati kábel

MAG BUDOWA APARATU

1. Miska
2. Generator bąbli
3. Dywanik kulkowy
4. Kulki masujące
5. Maksymalny poziom wody

6. Akcesorium relaksacyjne
7. Pumeks
8. Pokrywa podnóżka
9. Daszek podnóżka
10. Lejek

11. Przełącznik
12. Uchwyty do przenoszenia
13. Nogi do owijania sznura
14. Sznur zasilający

RF ХАРАКТЕРИСТИКИ

1. Кювета
2. Диффузор пузырьков
3. Коврик шариков
4. Массажные шарики
5. Максимальный уровень воды

6. Принадлежности для рефлексологии
7. Принадлежности для пилинга
8. Крышка "опоры для ног"
9. Козырек "опоры для ног"

10. Носик для наливания
11. Переключатель
12. Ручки для транспортировки
13. Ножки для обматывания шнура
14. Электрошнур