

LIFESTYLE<sup>®</sup> V30  
LIFESTYLE<sup>®</sup> V20

***BOSE***<sup>®</sup>







89/336/EEC Low Voltage Directive 2006/95/EC.  
EMC RTTE 99/5/EC.

[www.Bose.com/static/compilance/index.html](http://www.Bose.com/static/compilance/index.html).



Lifestyle® V20. : Lifestyle® V30; Acoustimass®.  
: : \_\_\_\_\_ Acoustimass: \_\_\_\_\_  
: \_\_\_\_\_ : \_\_\_\_\_ : \_\_\_\_\_  
Bose

---

.....	<b>2</b>
.....	2
.....	2
.....	2
.....	2
..... DVD .....	3
.....	3
.....	4
.....	5
.....	6
.....	8
.....	8
.....	8
.....	10
.....	11
.....	12
.....	12
.....	12
.....	12
..... Acoustimass®.....	12
.....	14
..... FM .....	14
..... AM .....	14
.....	14

..... / .....	15
..... SCART ( .....	17
..... ) .....	18
..... - .....	19
.....	<b>20</b>
.....	20
.....	21
.....	<b>28</b>
.....	28
..... Lifestyle® .....	28
.....	29
.....	29
..... HDMI .....	30
..... Bose® .....	30
..... / .....	30
.....	31
..... HDMI .....	31
..... HDMI .....	31

DVD	.....	32	.....	<b>48</b>
DVD-Lifestyle®	.....	32	Bose® link	.....
DVD-HDMI	.....	33	.....	51
HDMI	.....	33	.....	51
Bose®	.....	34	Bose® link	.....
HDMI	.....	34	Lifestyle®	.....
HDMI (AUX)	.....	35	.....	52
Bose®	.....	35	.....	53
AUX	.....	36	.....	54
HDMI	.....	37	.....	58
HDMI (HDMI)	.....	38	.....	<b>59</b>
HDMI	.....	41	.....	
.....	.....	42	.....	
.....	.....	42	.....	
.....	.....	43	.....	
.....	.....	43	.....	
.....	.....	48	.....	
.....	.....	48	.....	
.....	.....	49	.....	



Bose® Lifestyle®.

:

,

« ' ' ».

:

, , :

- HDMI
- 
- ADAPTIQ®,

- 
- 
- 
- 
- 
- 

/

/

- 14



# DVD

DVD

Lifestyle®  
DVD

Lifestyle®

DVD-

DVD:

•

•

•

ADAPTiQ®

Lifestyle®

•

ADAPTiQ  
Lifestyle®

•

•

•

(DVD,

•

•

•

ADAPTiQ

AM FM

. .).

2.

DVD-

Lifestyle®

. 2.

1.

Lifestyle®.

Lifestyle®

( . . 1).

. 2

. 1

Lifestyle®.







DVD.  
 PLAY DVD-  
 DVD,  
 .28

" " .28

DVD Bose®

1. Exit  
 Lifestyle®

2. DVD-  
 DVD Lifestyle®

3. DVD-  
 DVD Bose®

Lifestyle®.

Lifestyle®.

AUDIO IN  
( . . . 3).

ADAPTiQ® audio

ADAPTiQ

ADAPTiQ

. 3,

AUX

. 3

ADAPTiQ.

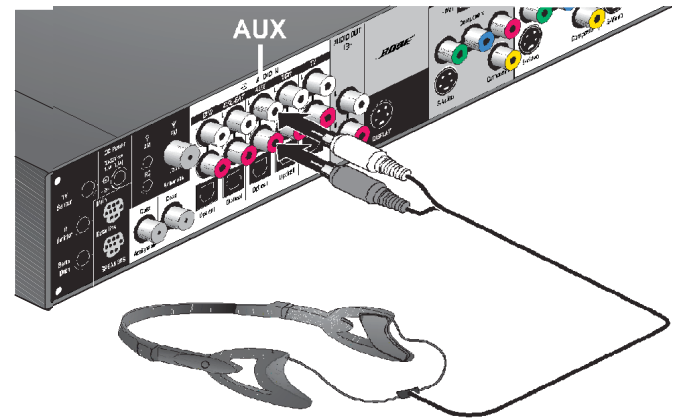

1. " " . 4. Lifestyle®, .
2. ADAPTiQ®,
3. Setup ( )
4. ADAPTiQ,



2.

Run.

3.



(Enter)

ADAPTiQ,

4.

. 4 Setup



Acoustimass®.

. iii.

( . . 5).

. 5

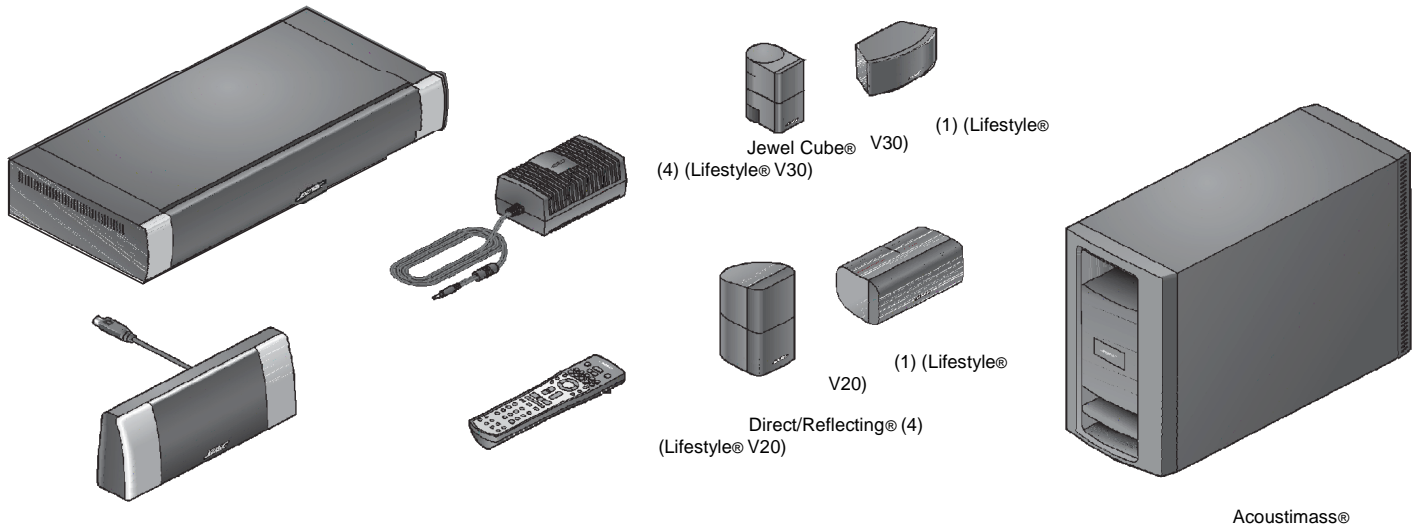

.6

.6

SCART (

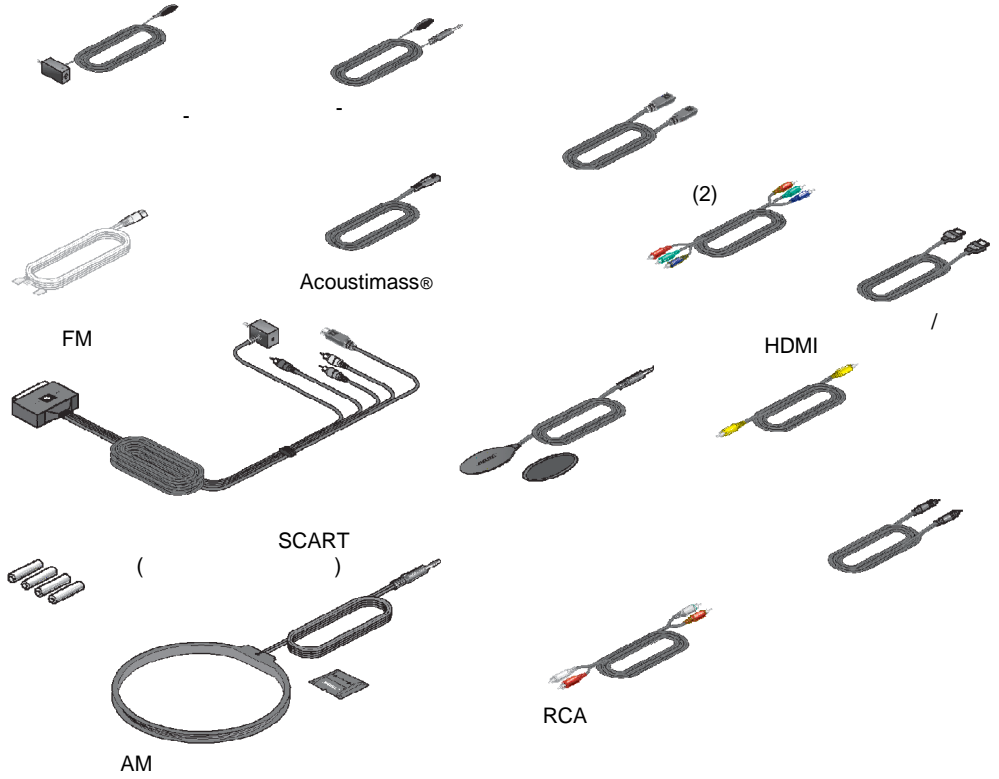
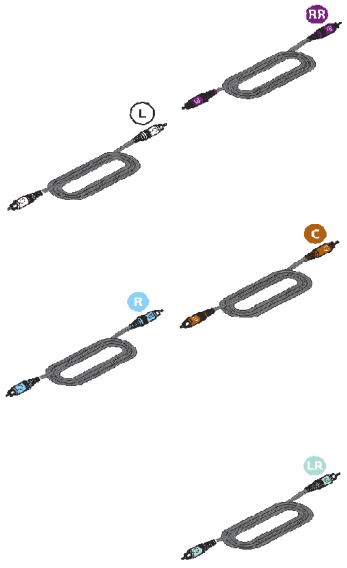

( , DVD, )

5

.7.

5

Bose

Bose®

Bose

www.Bose.com.

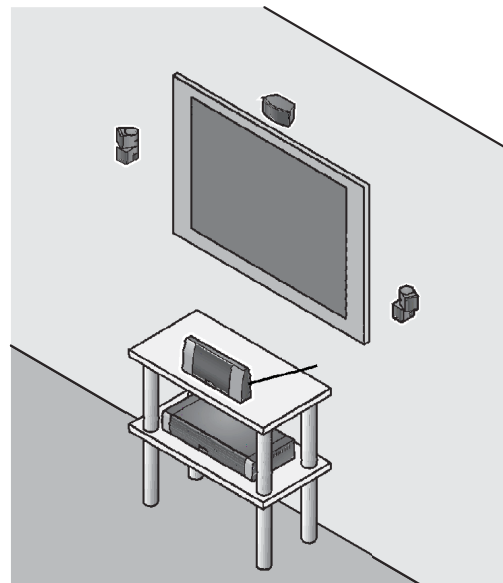

. 8

. 8

. 11,

ADAPTiQ®

ADAPTiQ®.

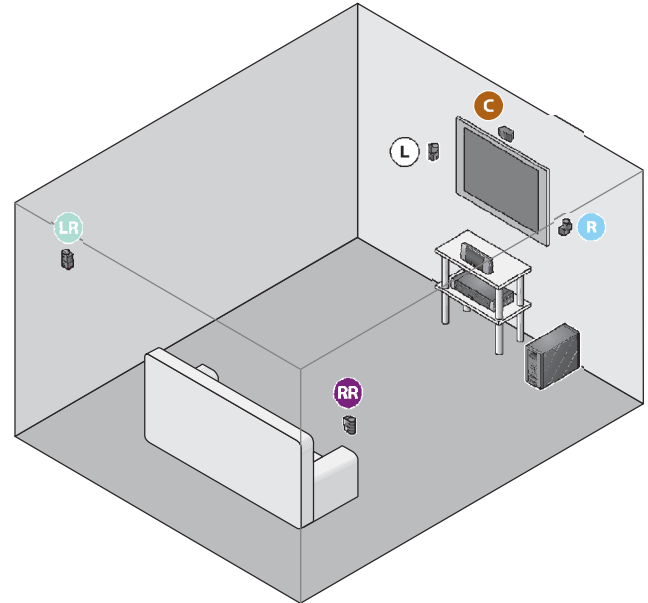
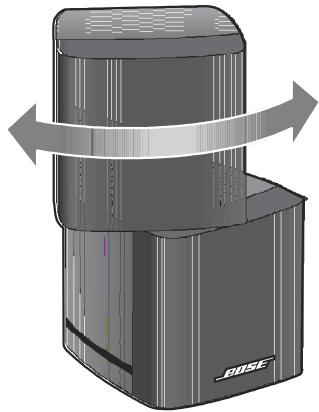



- 
- ( . . .8).
  - ,
  - , (6,1 )  
Acoustimass®.
  - 
  - 
  - 1 .
  - , (6,1 )  
Acoustimass®.
  - (15,2 )  
Acoustimass®.
  - 
  -



## Acoustimass®

. 9  
Acoustimass

( , ' ) .

Acoustimass® :

- ,
- ' ,
- 45 ,

- ,
- ' ,
- ' ,

- ,

( . 9) .

Acoustimass:

( . 9) .

- ,
- ' ,
- ,

- ,

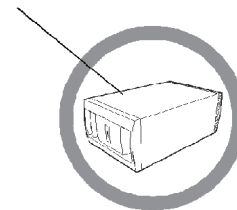
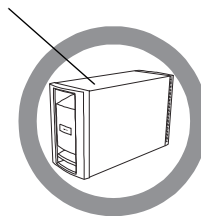

AM FM  
( . 10).

: FM

. 10

AM FM

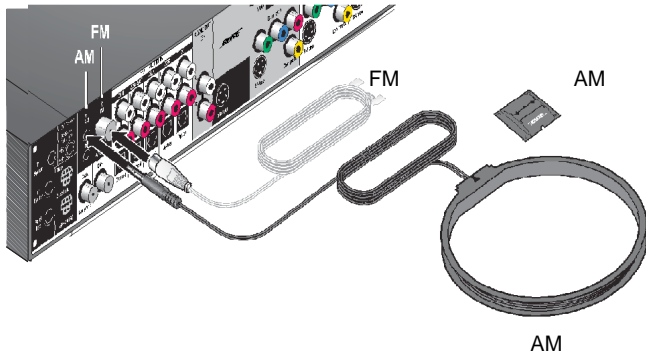

**FM**

1.

FM.

FM

2.

3.

Acoustimass®.

**AM**

1.

AM

AM.

2.

AM

3.

( 50 )

Acoustimass.

60

: AM

AM

FM

FM



/

1.

TV Sensor

SCART-

/

(DVD,

12 . 17).

( .

/

. .).

2.

/

( . 11).

,

:

,

/

,

. 11

/

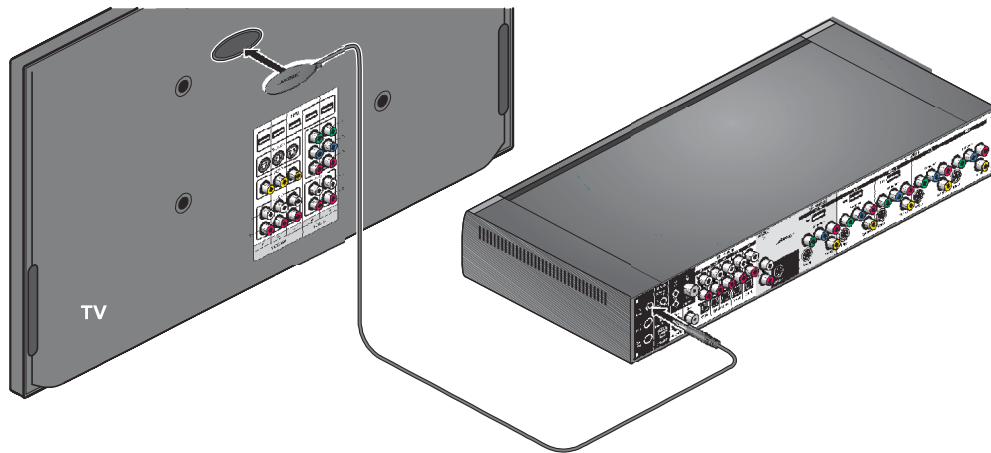

- 3.
4. System Lifestyle®.
5. Setup  ENTER.
6. TV Power, ENTER.
7. TV Power :
  - Automatic ( SCART).
  - Euro Connector ( SCART).



8. ENTER. TV Power Status ( TV Power Detected ( ) TV On ( Not )).
9. TV Power Status Not Detected TV On.
10. TV Power Status Exit TV On,

# SCART ( )

SCART

. 12

SCART

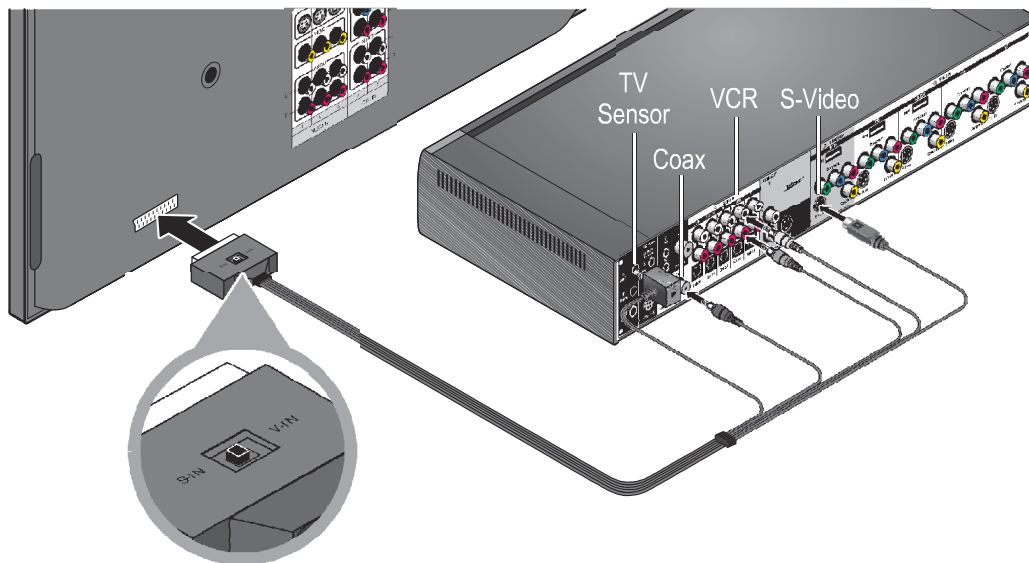

(FIX)

(VAR)

Fixed

Lifestyle®

Lifestyle®.

. 13

Lifestyle®:

RCA

(L)

(R)

(L R) TV Audio IN  
( . . 13).

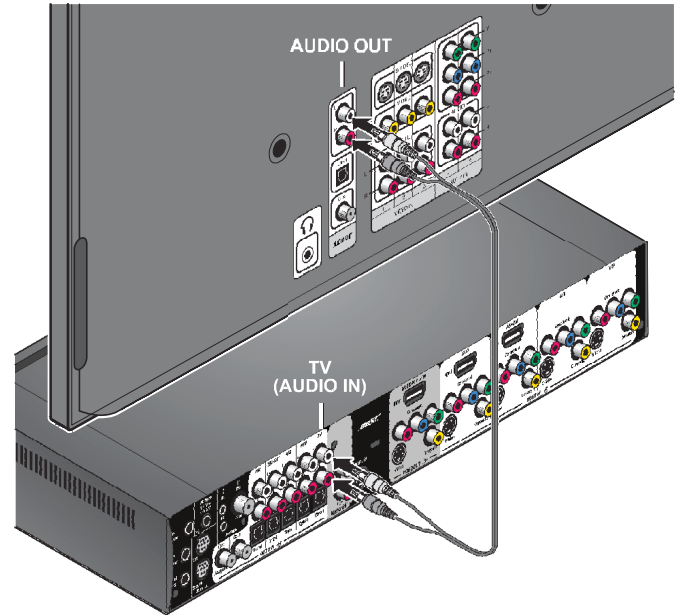

Lifestyle®

Lifestyle® —

Lifestyle®,

. 14

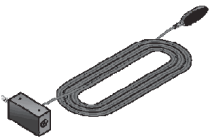

1.

**IR emitter**

2.

Lifestyle®.

3.

Lifestyle®.

4.

1.

Lifestyle®.

2.

3.

Lifestyle®.

4.

( ),



Lifestyle®.

. 1

Lifestyle®



**On/Off**

Bose®,

. ( .“ ” . 51).

**Source**

**Mute**

Bose®,

( .“ ” . 51).

**Vol -**

**Vol +**



. 2  
Lifestyle®

LIFESTYLE®

Lifestyle®,

- “ ” . 28.
- “ ” . 30.
- “ DVD” . 32.
- “ ” . 34.
- “ (AUX)” . 36.
- “ ” . 42.





**On/Off** – Lifestyle®

Bose®,

( . “

” . 51).

• **TV** –

Lifestyle®,

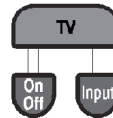

• **On/Off** –

• **Input** –



**Mute** –

Bose®,

( . “

” . 51)



• **CBL-SAT** –

CBL-SAT.



• **On/Off** –

Lifestyle®,

Lifestyle®

“ ”  
. 28.

DVD-

Lifestyle®.



• DVD –

, DVD.  
Lifestyle®,



• On/Off –

DVD.



• AUX –

, AUX.  
Lifestyle®,



• On/Off –

AUX .



• VCR –

, VCR.  
Lifestyle®,



• On/Off –

VCR.



FM –

FM-

Lifestyle®,



AM –

AM-

Lifestyle®,



Settings –

Info –



Info

VCR/DVR.



System

System –



Menu

Menu –



Exit

Exit

- Settings
- System.

Settings

VCR/DVR.

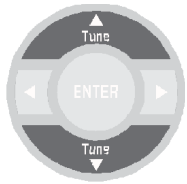

**Tune Up/Down**

•  
FM/AM

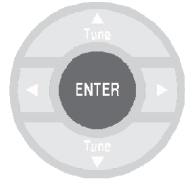

**Enter –**

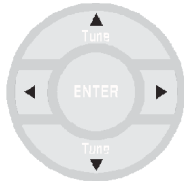

**Guide –**

( , , , ).  
VCR/DVR



**Page Δ**

**Page Up/Down –**



**Page ▽**

/ , VCR/DVR.

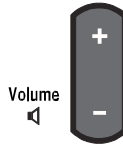

**Volume**

**Volume –**

• + ( )  
• -



**Channel  
Track**

**Channel/Track –**

,  
- DVD.



**Stop**

•

( FM/AM)  
DVD VCD:

•

(

),



**Pause** –

FM/AM)

(



**Play** –

( FM/AM)



**Scan**

•



**Repeat**

Repeat

•

•

MP3.

CD



**Record**



Shuffle

**Shuffle**



PIP

**Picture-in-picture –**

« »  
( ).



**Image View –**

Lifestyle® HDTV-

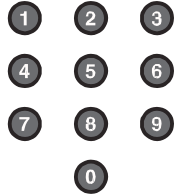

DVD, CD



Previous

**Previous –**

( ).



List –

List



A



B



C



Favorites

A, B, C Favorites  
,  
(DVR).

A.

B.

C.



Teletext –



–



–



–



–

( )

Lifestyle®  
 (HDTV).  
 Lifestyle®  
 On/Off .  
**Lifestyle®**  
 1. .  
 2. TV Lifestyle®.  
 ( . “ . 21).  
 3. **System,**  
 Lifestyle® .  
 TV” ( : Lifestyle®  
 “SYSTEM: SEE  
 ).  
 Lifestyle®.

4. Setup,  
 ENTER.  
 5. TV Brand  
 ENTER.  
 6. ENTER.  
 7. TV Code  
 ENTER.  
 8. .  
 9. (TV) On/Off ( TV).  
 •  
 •  
 (TV) On/Off.  
 10. ENTER.  
 TV Code: \_\_\_\_\_  
 11. Exit.



( . 15).

Lifestyle®

Lifestyle®

Audio Delay,

.15

1. **Settings**

Lifestyle®,

2.

**ENTER.**



3.

**ENTER.**

- 2 (

Lifestyle®).  
30

(1-8)

4.

**Exit.**

1.

Lifestyle®, **System**

2.

Setup,



**ENTER.**

3.

**Widescreen TV**

**ENTER.**

4.

**No**

**ENTER.**

5.

**Exit.**

HDTV.

Lifestyle®)

Image View  
(HDMI)"

. 38 "

" . 44

HDMI.

1. Lifestyle®,  
/ Bose®

2. Lifestyle®,

3. System,  
Lifestyle®

4. Setup  

5. ENTER. CBL•SAT Device,

6. ENTER.  
ENTER.

7. ENTER. CBL•SAT Brand

8. ENTER.

9. ENTER. CBL•SAT Code

10. Lifestyle® (CBL-SAT)

11. On/Off, CBL-SAT.  
•  
• (CBL-SAT) On/Off

12. ENTER.  
CBL-SAT Code: \_\_\_\_\_

13. Exit.

1. **System,** Lifestyle® HDTV, HDMI, Lifestyle®

2. **ENTER.** TV Control Lifestyle®

3. **CBL•SAT** **ENTER.** TV Control CBL-SAT HDMI” . 41 HDMI.

4. **Exit.** Lifestyle®

**HDMI**

HDTV.

( Lifestyle®), Image View (HDMI)” . 38 HDMI.

**DVD**  
 DVD- Lifestyle® Lifestyle®,  
 DVD- Lifestyle®  
**DVD-** Lifestyle®  
 DVD- DVD-  
 DVD, DVD Lifestyle®.  
 1. Lifestyle®.  
 2. DVD-  
 3. **TV** Lifestyle®. ( .  
 “ ”  
 21).  
 4. **System,**  
 Lifestyle®  
 5.   
**ENTER.**  
 6. **DVD Device**  
**ENTER.**  
 7. **ENTER.**  
 8. **DVD Brand**  
**ENTER.**

9. **ENTER.**  
 10. **ENTER.** **DVD Code**  
 11.  
 12. Lifestyle® (DVD)  
**On/Off,** DVD.  
 • DVD-  
 • DVD-  
**DVD On/Off**  
 13. **ENTER.**  
 DVD Code: \_\_\_\_\_  
 14. **Exit.**



Lifestyle®

HDMI

HDMI Lifestyle®

HDTV.

(

Image View (HDMI)

. 38

HDMI.

HDTV

HDMI,

Lifestyle®

HDMI” . 41

HDMI.

1. Lifestyle®.

2.

3. **TV** Lifestyle®. (

4. **System,**  
Lifestyle®

5. **ENTER.**

Lifestyle®,

**Bose®**

Lifestyle®.



6. **ENTER.** **VCR Device**

7. **ENTER.**

8. **ENTER.** **VCR Brand**

9. **ENTER.**

10. **ENTER.** **VCR Code**

11.

12. (VCR) **On/Off** (VCR).

•

•

**VCR On/Off**

13. **ENTER.**

14. VCR Code: \_\_\_\_\_ **Exit.**  
Lifestyle®

**HDMI**  
Lifestyle®  
HDMI,

HDTV , , ,  
.

Lifestyle®

HDMI” . 41  
HDMI.

Lifestyle®,  
 Lifestyle®  
 Bose®  
**AUX**  
 AUX,  
 AUX,  
 AUX  
 Lifestyle®.  
 Lifestyle®.  
 AUX.  
**AUX** Lifestyle®.  
**System,**  
 Lifestyle®  
**Setup,**  
**AUX Device**  
**ENTER.**

7. **ENTER.**  
 8. **ENTER.** **AUX Brand**  
 9. **ENTER.**  
 10. **ENTER.** **AUX Code**  
 11.  
 12. (AUX) **On/Off** (  
 AUX).  
 • AUX  
 • (AUX)  
**On/Off**  
 13. **ENTER.**  
 AUX Code: \_\_\_\_\_  
 14. **Exit.**  
 Lifestyle®





**HDMI**  
Lifestyle®  
HDMI,

HDTV

Lifestyle®

HDMI”

. 41

HDMI.

# (HDMI)

Image View

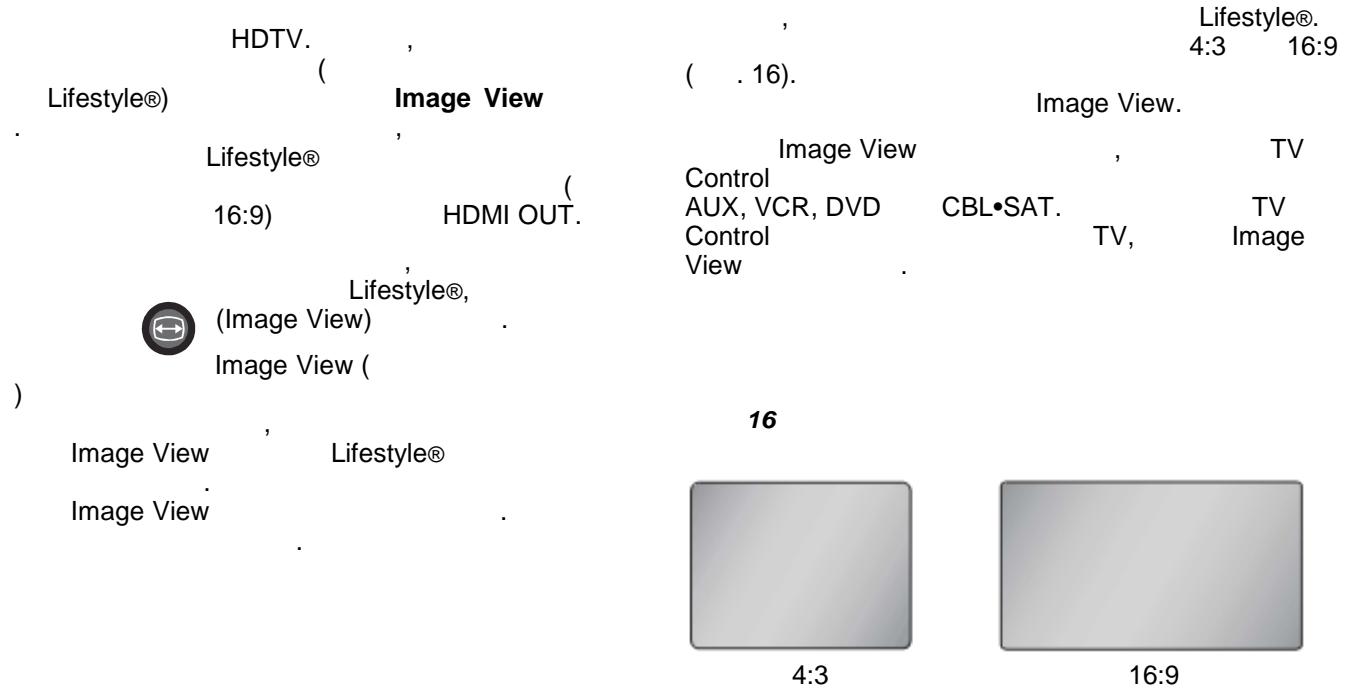







1.

4:3

		4:3
4:3	Normal ( )	
	Zoom ( 16:9 )	
	Stretch	
	Gray Bars	

2.

16:9

		16:9
16:9	Normal ( )	 → 
	Zoom ( )	 → 
	Stretch ( )	 → 

# HDMI

Lifestyle®

HDTV



Lifestyle®

HDTV Lifestyle® HDMI OUT.

Lifestyle® ( )

Lifestyle® VCR AUX ( ) CBL-SAT, DVD,

HDMI,

1. **Settings** Lifestyle®  
 ( )
2. A-D ( )  
 A. **System**,  
 B. **ENTER.**  ( ),  
 C. **Resolution** **ENTER.** **Video**  
 D. **Adjustable, Settings.** ( )
2. **ENTER.**  ,
3. **Exit.**

HDTV, \*default.

\*default. 1080i, 1080i



AM, FM 20 AM 20 FM

Tune Up Tune Down.

- 1.
- 2.
- 3.

Seek.

- 1 9 PRESET:xx SET  
( xx ).

- 10 20 Lifestyle® PRESET:xx

SET.

« », PRESET:xx ERASED ( )).

DVD- Lifestyle®  
"Assignable"  
«TV», «VCR», «CBL·SAT» «AUX».

1. Lifestyle®  
**System.**
2. Media Center,  
 **ENTER.**  
**Coaxial Source**
3. **ENTER.**
4. **ENTER.**
5. **Exit.**





Lifestyle®,

HDTV





1. **Settings,**
2. **Enter.**
- 3



3.



Settings

		( )	
	2-3-5	5 (2, 3, 5 )	3. AUDIO. 5
	Surround ( )	0 (-10, -9, -8, -7, -6, -5, -4, -3, -2, -1, 0, +1, +2, +3, +4, +5, +6)	
	Center Channel ( )	0 (-8, -7, -6, -5, -4, -3, -2, -1, 0, +1, +2, +3, +4, +5, +6, +7, +8)	
	Audio Delay ( ) ( FM-AM)	2 (0, 1, 3, 4, 5, 6, 7, 8)	



	( )	
 <p>Movie EQ ( ) ( FM-AM)</p>	<p>On ( .) Off ( .)</p>	<p>( Audio Processing System User Adjustable). Digital . Dolby</p>
 <p>Range Compression ( ) ( FM-AM)</p>	<p>On ( .) Off ( .)</p>	<p>( Audio Processing System User Adjustable).</p>
 <p>Mono Decoding ( FM-AM)</p>	<p>On ( .) Off ( .)</p>	<p>( Audio Processing System User Adjustable). Decoding ( ), Mono Videostage® (2, 3 5)</p>
 <p>Audio 1 + 1 ( FM-AM)</p>	<p>1 (2, )</p>	<p>( ) Video CD HDTV. Video CD (1+1). Audio 1 + 1 1, 2</p>

		( )	
	SD Progressive Scan ( ) ( FM-AM)	On ( . ) Off ( . )	( Lifestyle® ) (480/576i) (480/576p).
	Video Resolution ( ) ( HDTV)	1080p (1080i, 720p, 480/576p)	( Lifestyle® HDMI). Lifestyle® Lifestyle® HDTV
	Image View ( ) ( HDTV)	Normal (Zoom, Stretch, Gray Bars)	( Lifestyle® HDTV HDMI). HDTV ( . “ (HDMI) ” . 38). TV Control AUX, VCR, DVD CBL•SAT, Image View TV, Image View

	( )	
 <p>Output Mode ( ) ( ) FM)</p>	<p>Auto (Mono - Stereo)</p>	<ul style="list-style-type: none"> <li>• <b>Auto</b> – FM-</li> <li>• <b>Mono</b> – FM-</li> <li>• <b>Stereo</b> – FM-</li> </ul>
 <p>RDS Info ( RDS) ( ) FM)</p>	<p>On ( .) Off ( .)</p>	<p>RDS</p>
 <p>Sleep Timer ( )</p>	<p>Off ( .) (10-90)</p>	<p>Lifestyle®</p> <p>90 10- 10</p> <p>3 Off.</p>

3.

. 17.

. 49.

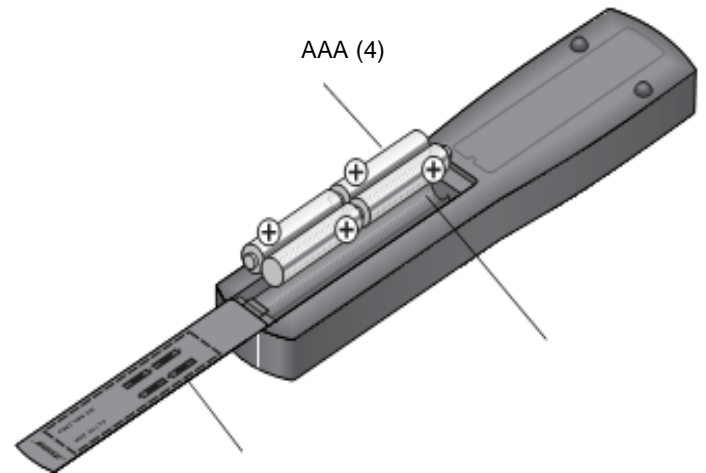

1.

. 17.

2.

IEC-LR3,

1,5

+ -

LIFESTYLE®

LIFESTYLE®

2.

Mute

1-4:

: ■■■■■

0000.

4.

Mute,

1.

( .18 .50).

2.

4

1,2,3

( , 2 1 3 4 1010.)

5.

Mute.

6.

3.

1-3.

4-5.

1.

On/Off

Mute,

1-4.

. 18.

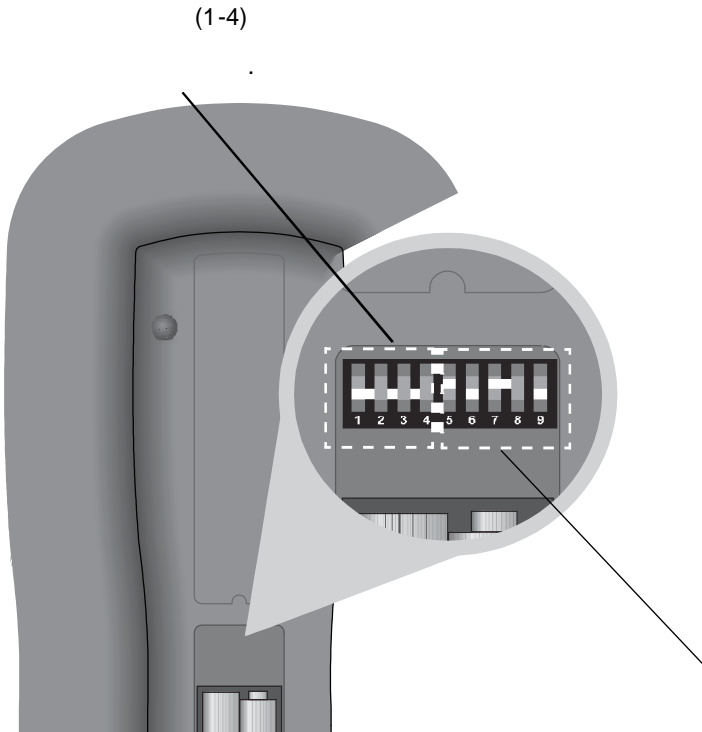

5  
( )

“ . 51.

6-9

**Bose® link**

1-4

5-9



**Bose® link**

LIFESTYLE®

) (

Bose® link.

Bose

AUX)

( , AM/FM- , DVD

:

II, 3•2•1 GS Series II

Wave®, Bose® link AL8,  
3•2•1 GSX, 3•2•1® Series  
Lifestyle® RoomMate®

14 LIFESTYLE®

Bose® link

Personal® II,

Lifestyle® V-Class.

Bose® link

Bose.

Bose,

**Bose® link**

(1, 2, 3 4)

5:

(A).

(A).

(6, 7, 8 9)

(A)



B



I



C



J



D



K



E



L



F



M



G



N



H



O





---

# Lifestyle®

- [Illegible]
- [Illegible]

	<ul style="list-style-type: none"> <li>• , Acoustimass®</li> <li>• , (DVD, VCR, FM . . .)</li> <li>• Lifestyle®.</li> <li>• ,</li> <li>• ,</li> </ul>
	<ul style="list-style-type: none"> <li>•</li> <li>• , MUTE ( . . . ) <b>Mute</b></li> <li>• ,</li> <li>• , FM AM.</li> <li>• , Acoustimass ON.</li> <li>• , :</li> <li>– multi-pin, AUDIO INPUT. Acoustimass</li> <li>•</li> <li>•</li> <li>• , Acoustimass ON.</li> </ul>

( )	<ul style="list-style-type: none"> <li>• Bose®.</li> </ul>
	<ul style="list-style-type: none"> <li>• , 3 5 .</li> </ul>
	<ul style="list-style-type: none"> <li>• Central Channel ( ).</li> </ul>
	<ul style="list-style-type: none"> <li>• 5</li> <li>• Surround , .</li> <li>• , (DVD, VCR, DVR . .)</li> </ul>
	<ul style="list-style-type: none"> <li>• Surround , .</li> <li>• , .</li> </ul>
( ) .	<ul style="list-style-type: none"> <li>• (+ -).</li> <li>• , , .</li> <li>• « ».</li> <li>• Bose .</li> </ul>

Lifestyle®	<ul style="list-style-type: none"> <li>• (HDMI, , S-video )</li> <li>• « , »</li> <li>• Bose®.</li> </ul>
	<ul style="list-style-type: none"> <li>• LIFESTYLE®, " . 49). ( . “</li> </ul>
	<ul style="list-style-type: none"> <li>•</li> <li>• AM , 50 ,</li> <li>• Acoustimass®.</li> <li>• , AM</li> <li>•</li> <li>•</li> <li>•</li> </ul>
FM	<ul style="list-style-type: none"> <li>•</li> </ul>
FM	<ul style="list-style-type: none"> <li>• FM 2</li> </ul>
	<ul style="list-style-type: none"> <li>•</li> <li>•</li> </ul>
DVD, VCR, CBL-SAT AUX	<ul style="list-style-type: none"> <li>•</li> <li>•</li> <li>•</li> </ul>

	<ul style="list-style-type: none"> <li>• , , . . . . .</li> </ul>
<p>Lifestyle®</p> <p>, DVD-</p> <p>/ ,</p>	<ul style="list-style-type: none"> <li>• . . . . . “ ” . 28.</li> <li>• , . . . . .</li> <li>• IR EMITTER ( ) . 19.</li> </ul>
	<ul style="list-style-type: none"> <li>• SCART,</li> <li>• <b>TV Power Status</b> Video System.</li> </ul>
<p>Video</p>	<ul style="list-style-type: none"> <li>• System , NTSC ( )</li> <li>• PAL ( ).</li> <li>• Settings , SD Progressive Scan ,</li> </ul>



! - ,

Bose®.

!

Bose.

**4:3** – « ».  
**5.1**– – 5.1-

**16:9** – « ».  
**C CD** – - .

**D Dolby Digital** –  
Laboratories, Dolby  
 – Dolby Digital.

**DTS** – Digital Theater Systems  
( ),  
**CD DVD** ,

 – DTS.

**DVD** – Digital  
Video Disc ( ) Digital

Versatile Disc ( )  
DVD CD,

**DVD-R, DVD+R, DVD-RW, DVD+RW** –

(R) (RW) -  
( ) (DVD).  
DVD-R +R  
DVD-RW +RW

**DVD-ROM** – Read Only  
Memory – (ROM)  
(DVD).

**DVD video** –  
ROM, MPEG, DVD-  
Digital Dolby

**DVR** – Digital Video Recording  
( ),  
PVR (Personal Video Recording). DVR

**H HDCP** – High-bandwidth Digital Content Protection. HDCP — Digital Content Protection, LLC (DVI) (HDMI).

**HDMI** – High-Definition Multimedia Interface (HDMI) —

**HDTV** – High-Definition TV (HDTV)

**M MP3** – (MPEG-1 Layer III),

**MPEG** – Moving Picture Experts Group

**N NTSC** – National Television System Committee

**P PAL** – Phase Alternate Line.

**PCM** – Pulse Code Modulation (PCM).

**PVR** – Personal Video Recording (PVR) (Digital Video Recording),

**RDS** –



**S SCART** –

( ) DVD-

**S-video** –

( - )

S-video

/

S-video.

DVD-

Lifestyle®.

**V Video CD** –

(CD),

**Videostage® 5** –

Bose®,

Lifestyle®.

YPbPr.

VHS,

CD

S-video.

**Y YPbPr** –

YUV

Y, B-Y, R-Y.

**A**

( - )

( )  
( )

RCA.



Lifestyle®.

4:3

( , ), 4

3 . :4:3 16:9.

4:3 ( ) 16:9 ( ) . «

30

«

»),

4:3 ( .

( )

9

16:9 ( . « - 16





305385

***BOSE***<sup>®</sup>  
*Better sound through research*<sup>®</sup>

©2007 Bose Corporation, The Mountain,  
Framingham, MA 01701-9168 USA  
AM305385 Rev.00