

Always there to help you

Register your product and get support at
www.philips.com/welcome



HTB5520G
HTB5550G
HTB5580G

Quick start guide

PHILIPS



EN Before using your product, read all accompanying safety information

RU Перед тем как использовать это изделие, ознакомьтесь с информацией, касающейся безопасности.

UK Перед початком роботи прочитайте всю супутню інформацію про безпеку.

KK Өнімді пайдаланбастан бұрын, барлық қосымша қауіпсіздік ақпаратын оқыңыз.



HTB5520G

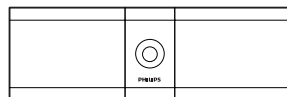
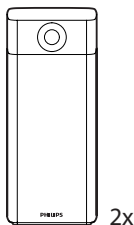
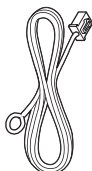
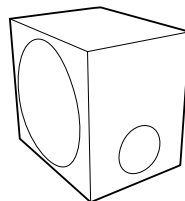
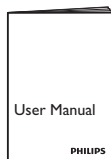
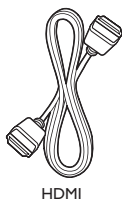
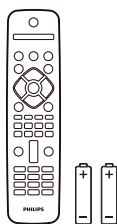
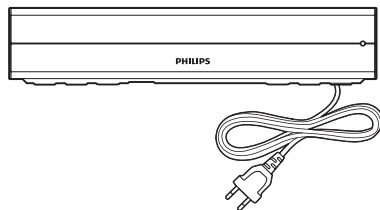
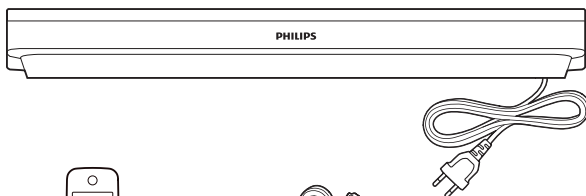

HTB5550G

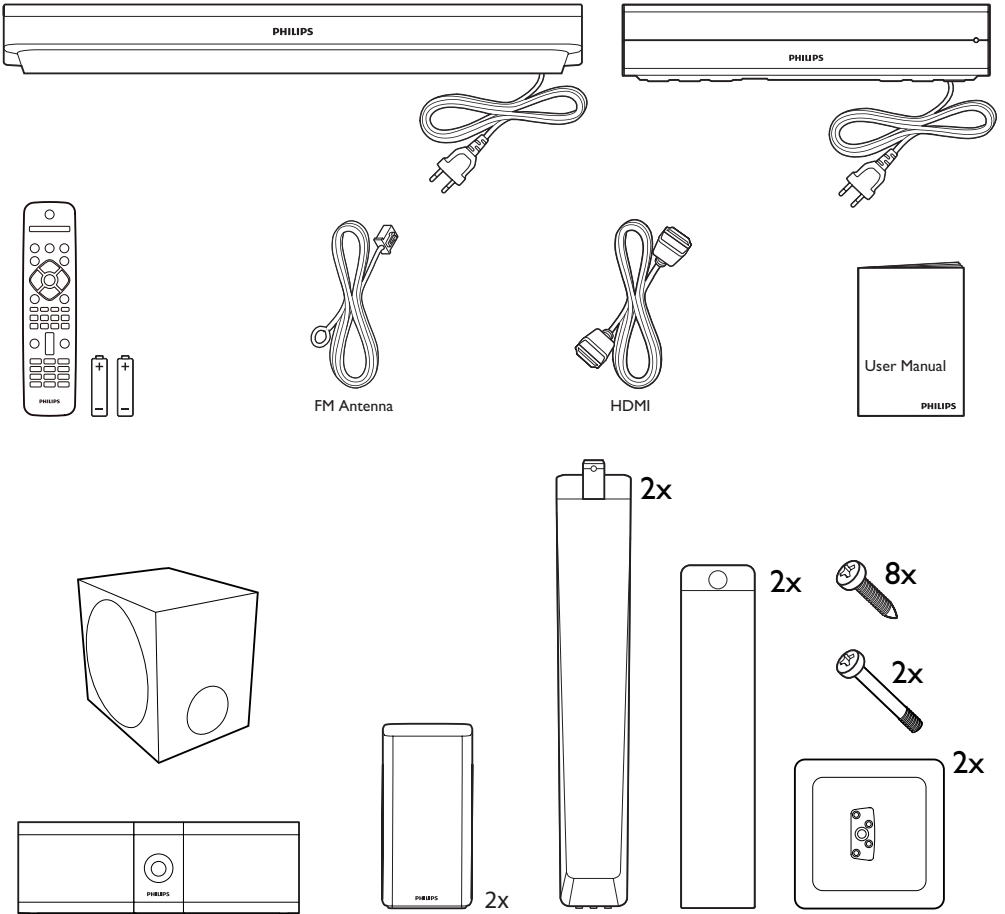

HTB5580G

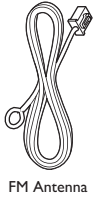
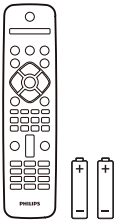
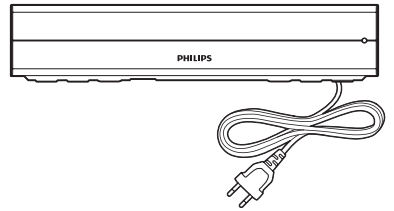
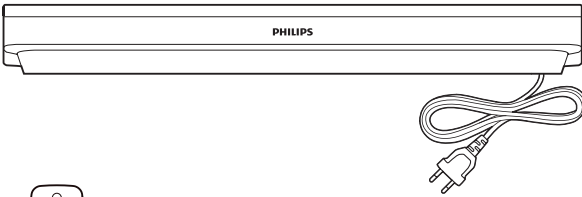

FM Antenna

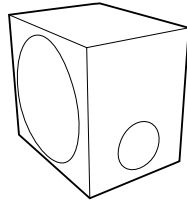

HDMI

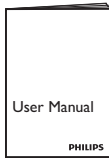

User Manual

PHILIPS

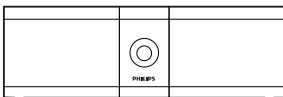

PHILIPS



4x



4x



16x



4x

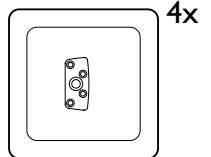

4x

1

EN Stand mount the speakers
Applied to HTB5550G and
HTB5580G only

RU Установка АС на подставку
Применимо только для мод елей
HTB5550G и HTB5580G

UK Встановлення гучномовців на
підставку
Доступно лише для моделей
HTB5550G та HTB5580G

KK Динамиктерді тірекке орнату
Тек HTB5550G және HTB5580G
үшін қолданылады

1

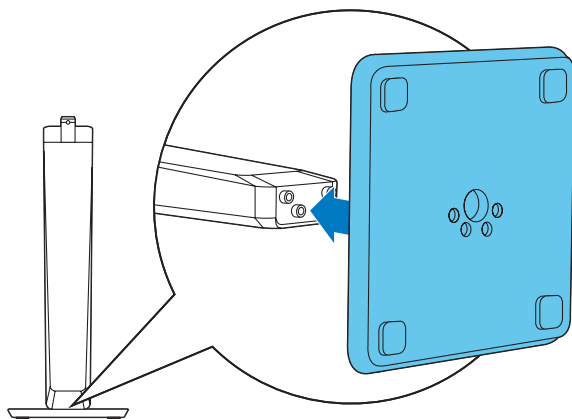

2

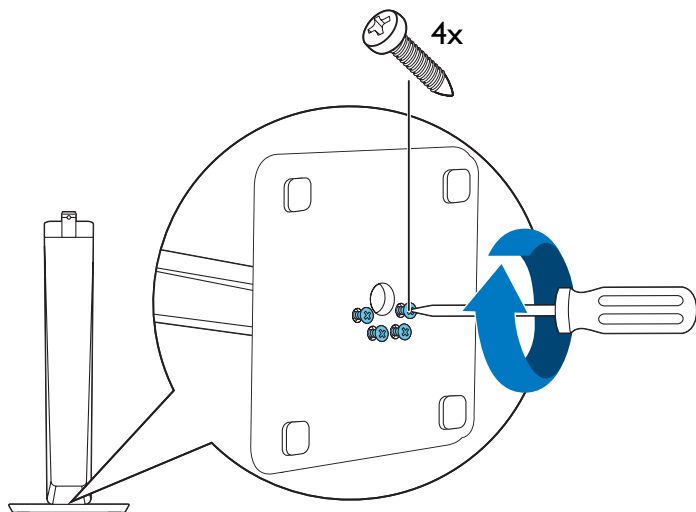

3

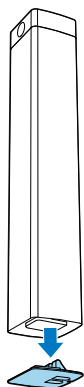

4

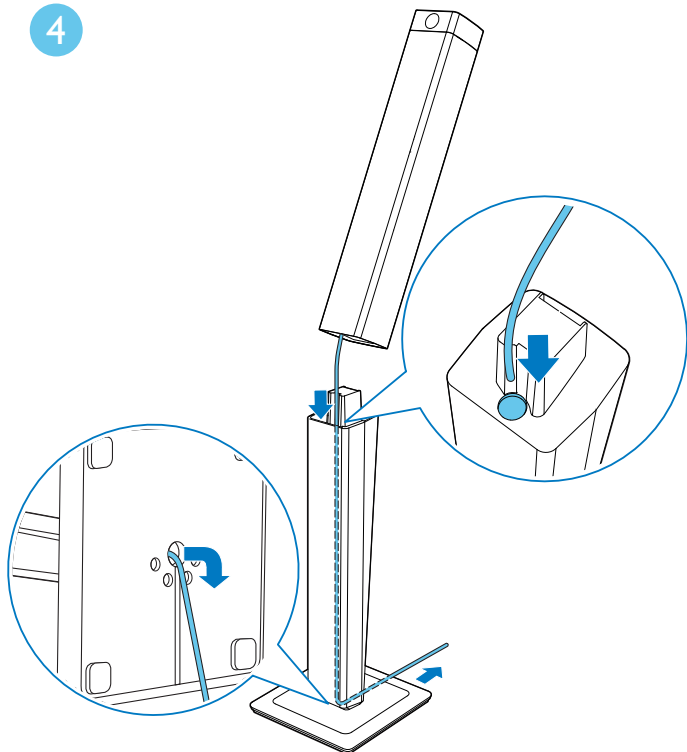

5

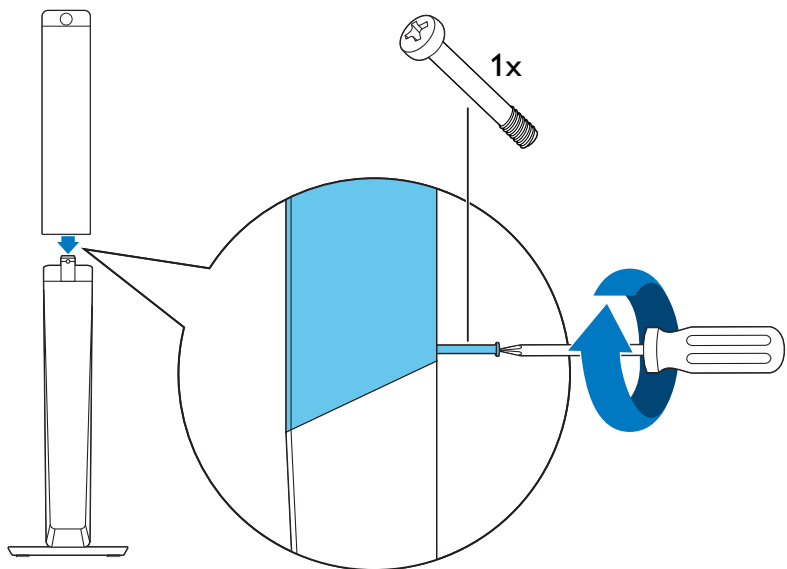

2

EN Connect and position the home theater

RU Установите и подключите домашний кинотеатр

UK Під'єднання і розташування системи домашнього кінотеатру.

KK Үй кинотеатрын жалғап, орнату

HTB5520G

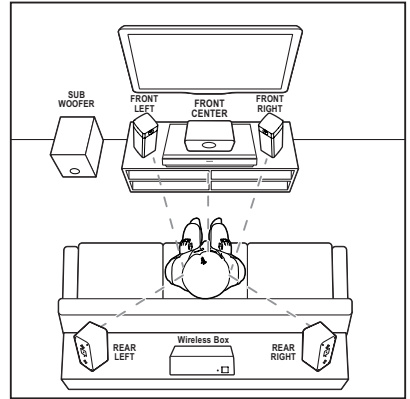
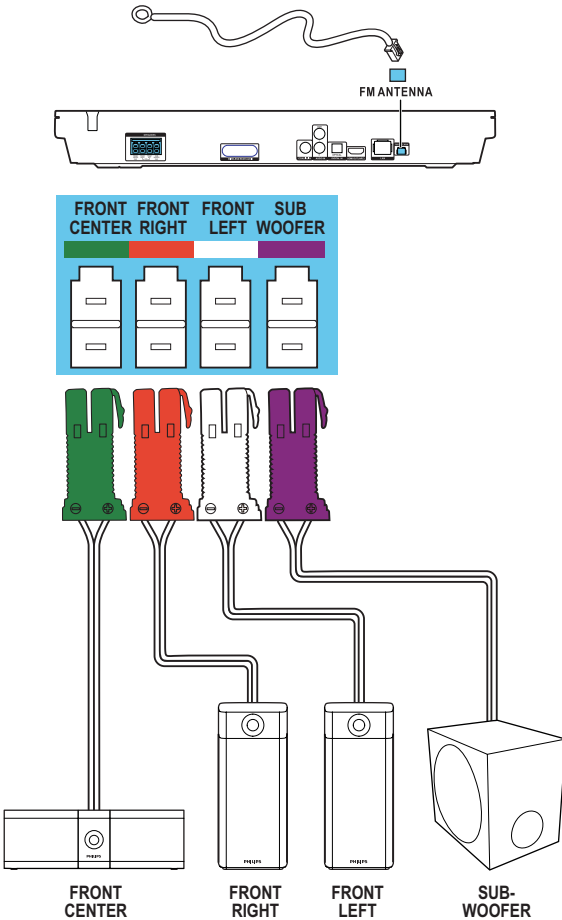

Wireless Box

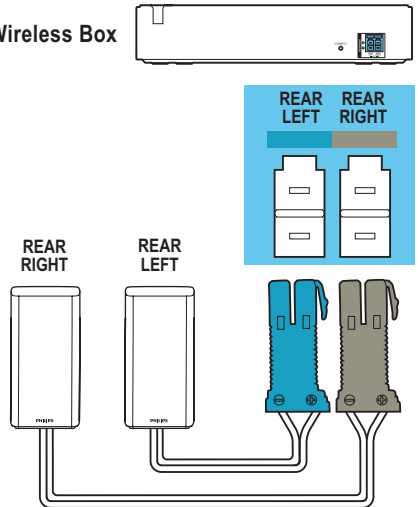

HTB5550G

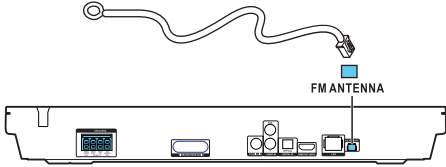

FRONT FRONT FRONT SUB
CENTER CENTER LEFT WOOFER

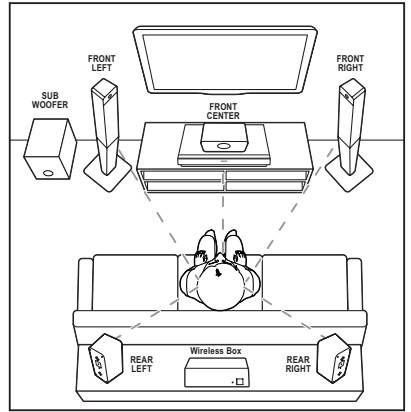
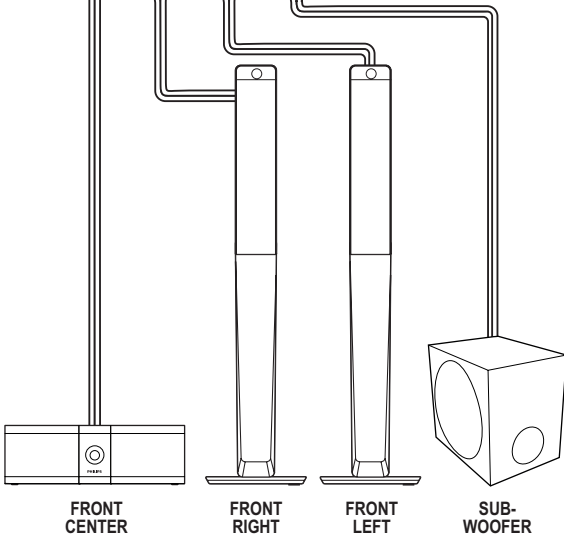
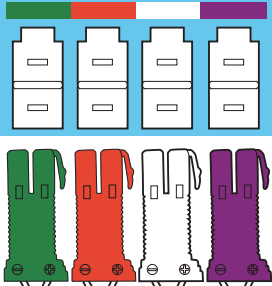

Wireless Box



REAR REAR
LEFT RIGHT

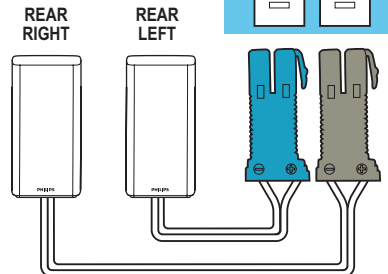

HTB5580G

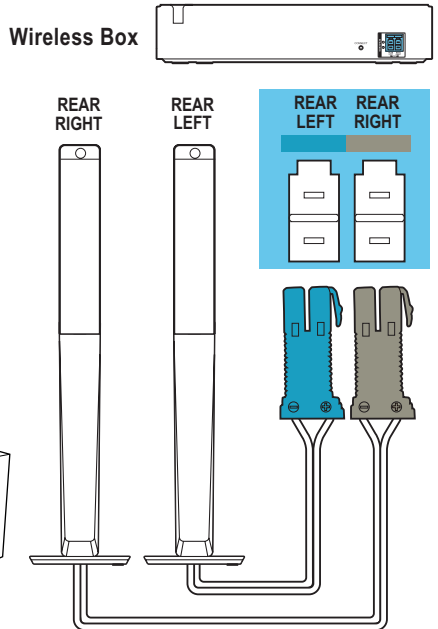
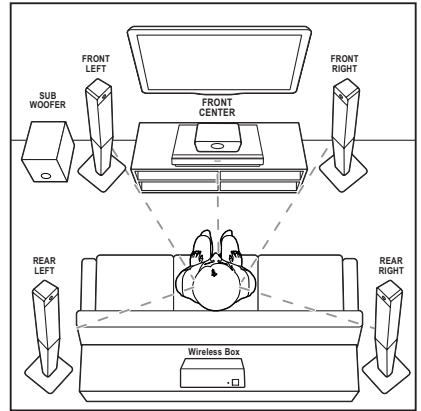
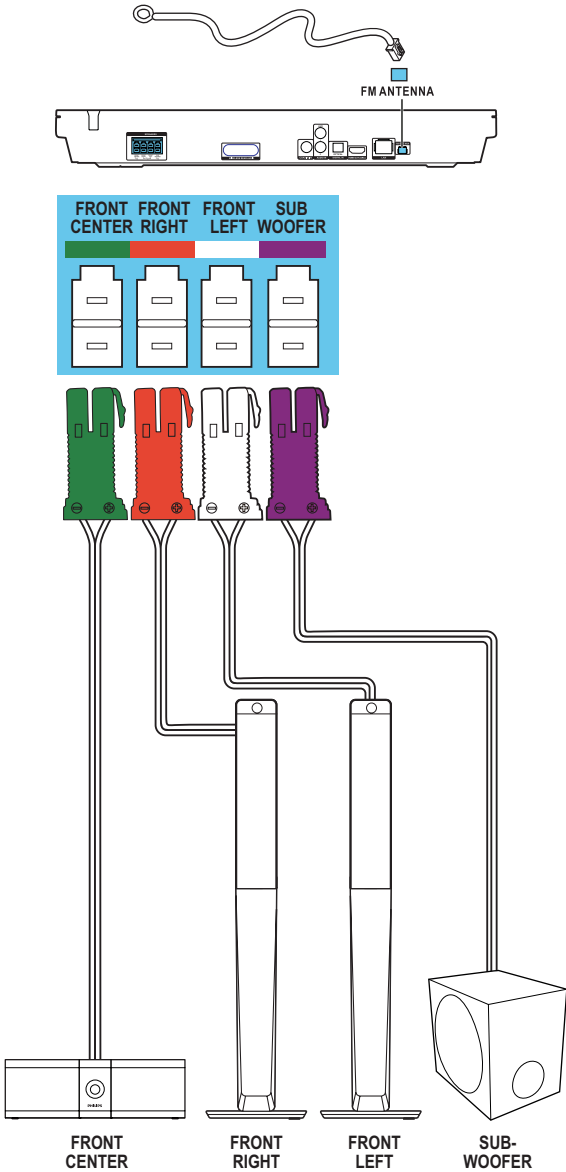

3

EN Connect to TV in one of these ways
RU Выполните подключение к ТВ одним из следующих способов

UK Під'єднання телевізора в один із поданих способів
KK Мына әдістердің біреуімен теледидарға жалғау

HDMI ARC

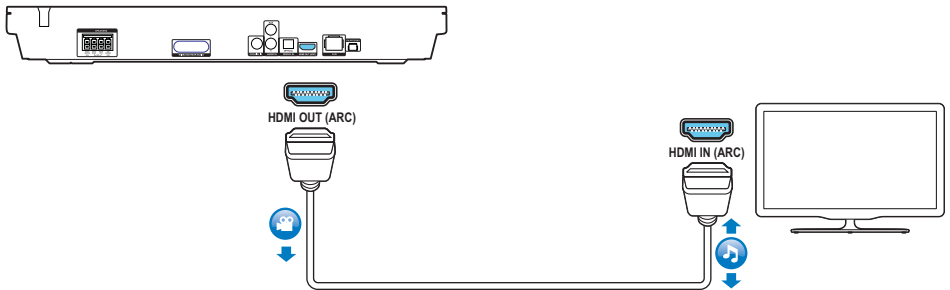

HDMI + OPTICAL

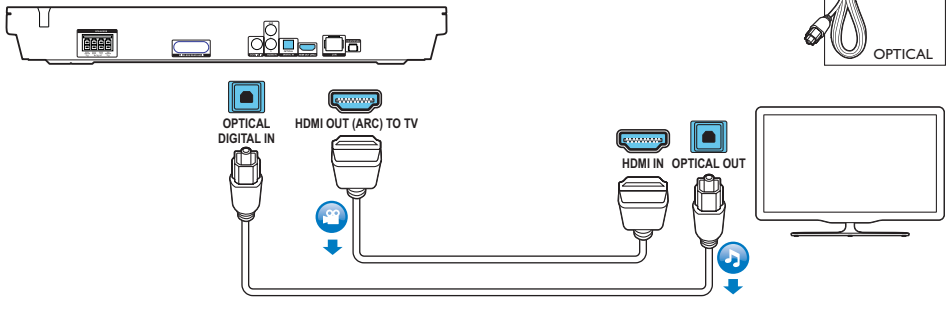

HDMI + COAXIAL



COAXIAL IN

HDMI OUT (ARC)



HDMI IN

COAXIAL OUT

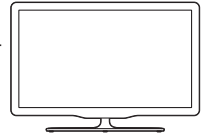

HDMI + AUDIO L/R



AUDIO IN

HDMI OUT (ARC) TO TV



HDMI IN

L

AUDIO OUT

R

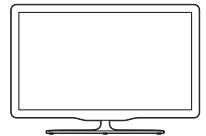

4a

EN Switch on the home theater
RU Включите домашний кинотеатр

UK Увімкнення системи домашнього кінотеатру

KK Үй кинотеатрын қосу

1

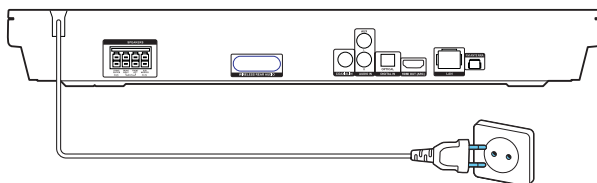

2

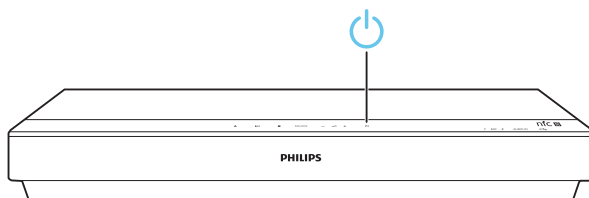

3

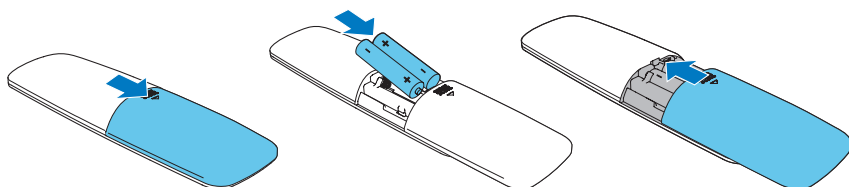

4b

EN Pair up the rear speakers (for the written instructions on pair-up of the rear speakers, refer to Chapter 3 "Connect and setup" of the User Manual)

RU Сопряжение тыловых АС (инструкции по сопряжению тыловых АС см. в главе 3 руководства пользователя "Подключение и установка")

UK З'єднайте в пару задні гучномовці (письмові вказівки щодо з'єднання в пару задніх гучномовців читайте в розділі 3 "Під'єднання та налаштування" посібника користувача).

KK Артқы динамиктерді жұптаңыз (артқы динамиктерді жұптау туралы жазбаша нұсқауларды пайдаланушы нұсқаулығының «Қосылу және реттеу» деген 3-тарауынан қараңыз)

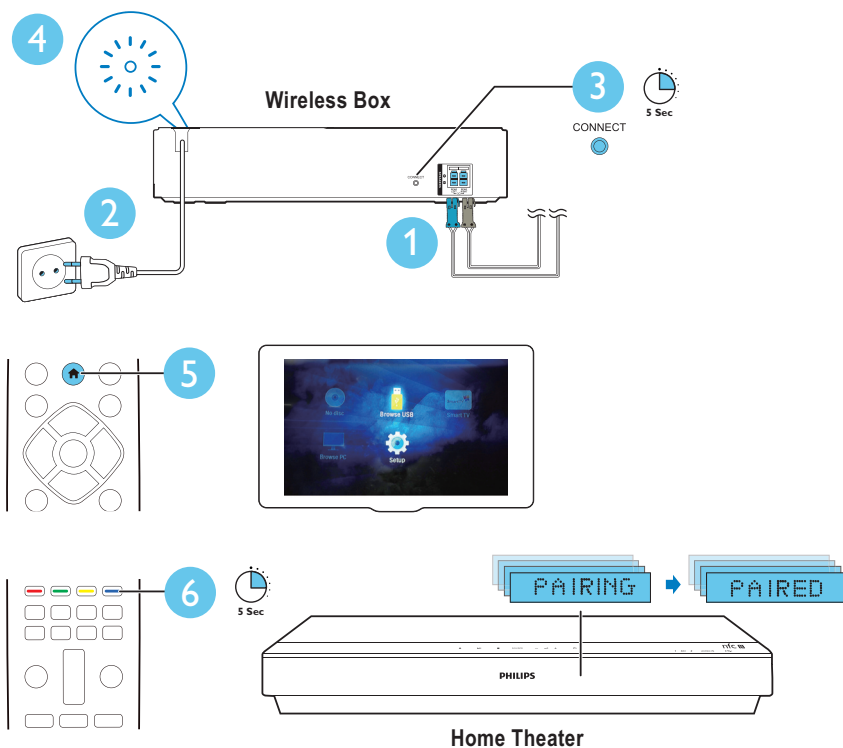

5

EN Complete the first time setup

RU Выполните первоначальную настройку

UK Виконання перших налаштувань

KK Бірінші рет параметрлерді орнатуды орындау

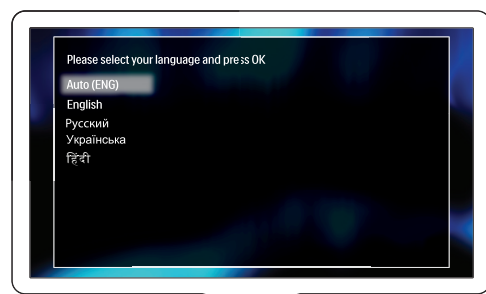
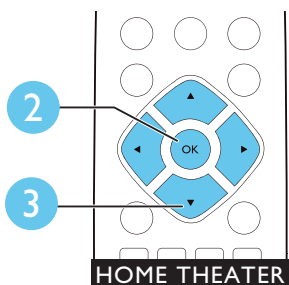
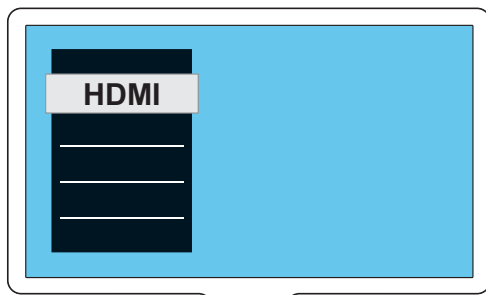
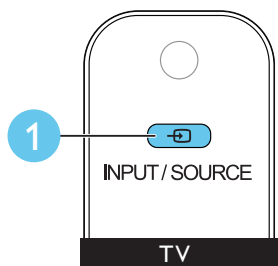

6

EN Use your home theater
RU Домашний кинотеатр готов к использованию

UK Використання системи домашнього кінотеатру

KK Үй кинотеатрын пайдалану

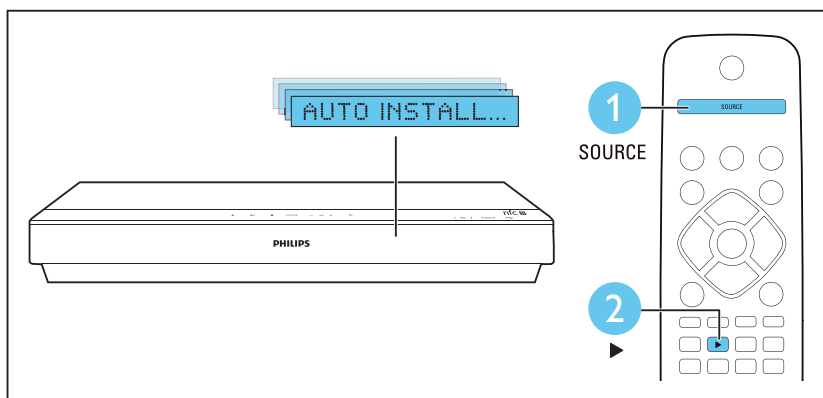
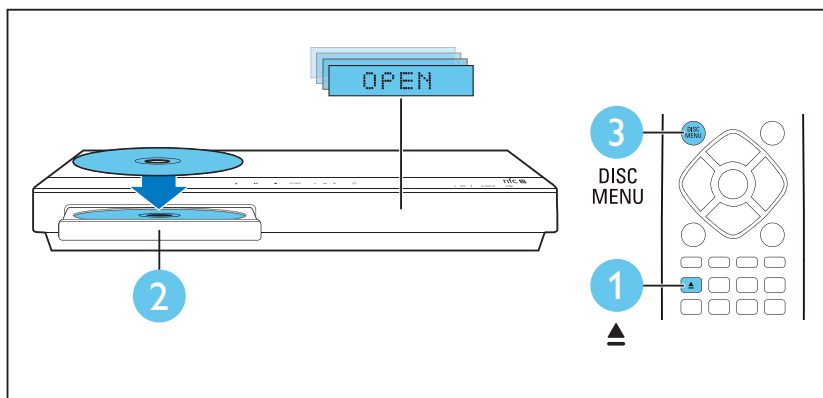

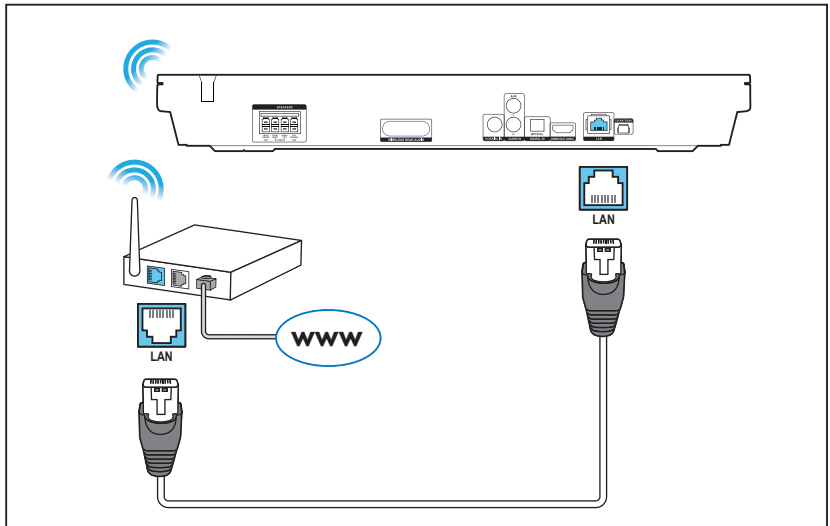
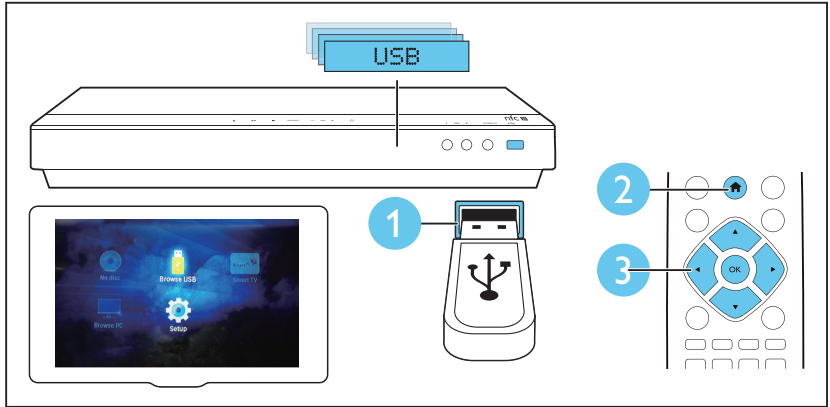
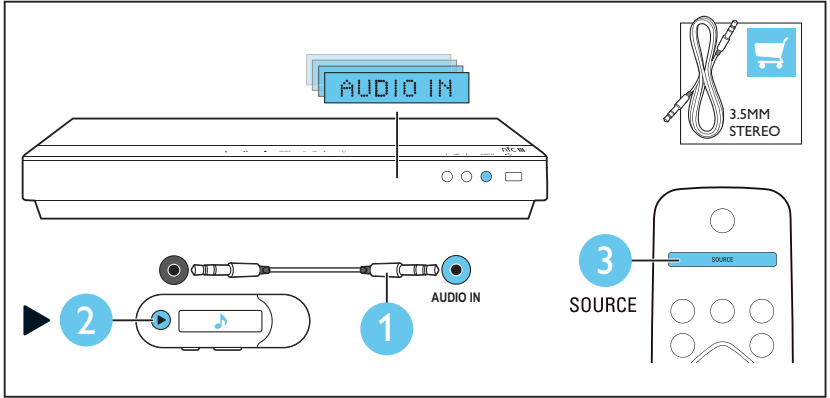

7

EN Play audio through Bluetooth or connect Bluetooth via NFC

RU Включите воспроизведение аудио через Bluetooth или установите подключение Bluetooth с помощью NFC

UK Відтворення аудіо через Bluetooth або з'єднання Bluetooth через NFC

KK Bluetooth арқылы дыбысты ойнату немесе NFC арқылы Bluetooth қосу

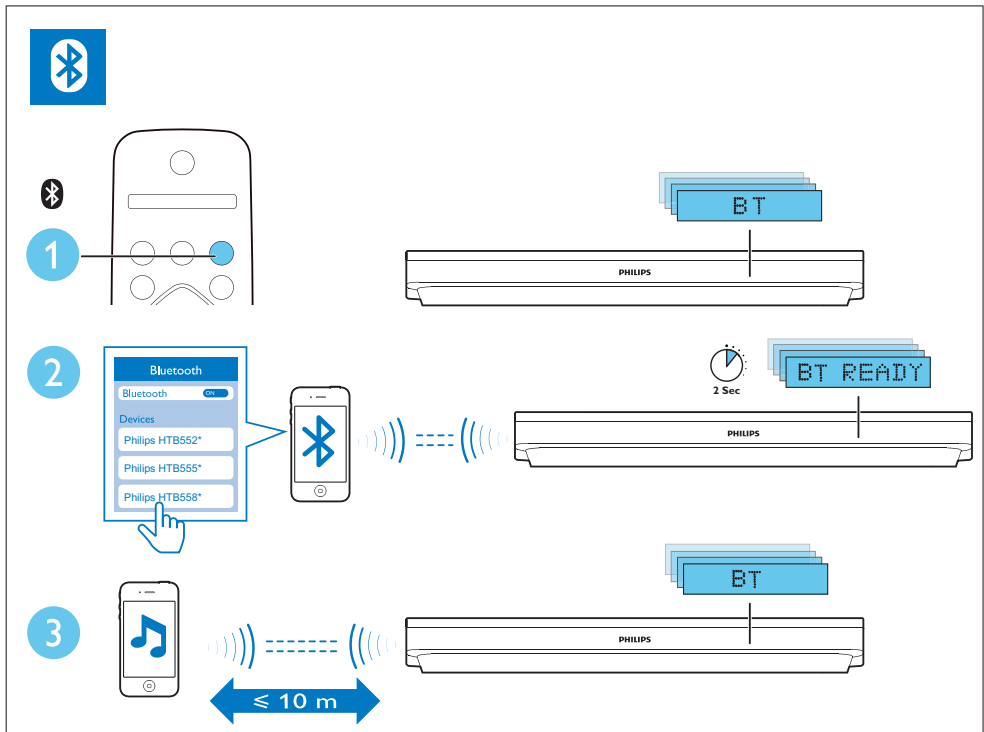

nfc

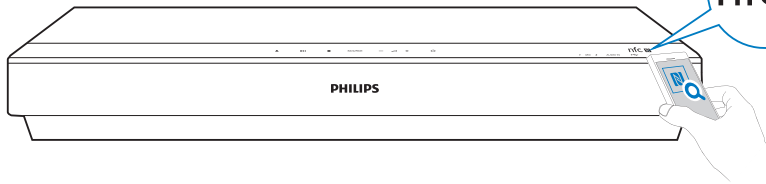



EN For more information about using this product, visit www.philips.com/support

RU Дополнительную информацию об использовании устройства см. на веб-сайте www.philips.com/support

UK Докладнішу інформацію про цей виріб шукайте на www.philips.com/support

KK Өнімді пайдалану бойынша қосымша ақпаратты алу үшін www.philips.com/support сайтына кіріңіз.



www.philips.com/support



Specifications are subject to change without notice
© 2014 Koninklijke Philips N.V. All rights reserved.
Trademarks are the property of Koninklijke Philips N.V. or
their respective owners.

HTB5520G/5550G/5580G_51_QSG_V1.0

