

JBL® FLIP

OWNER'S MANUAL

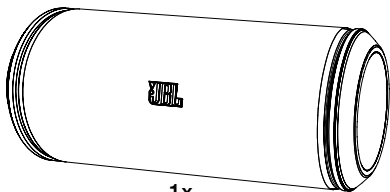

1x

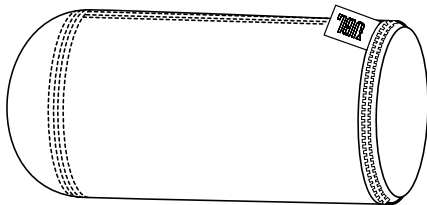

1x

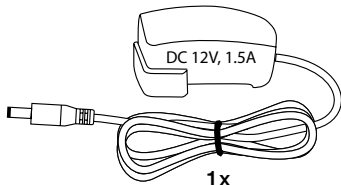

1x

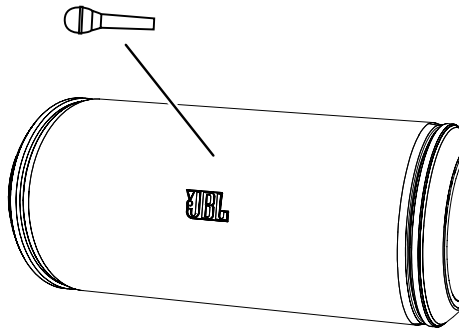
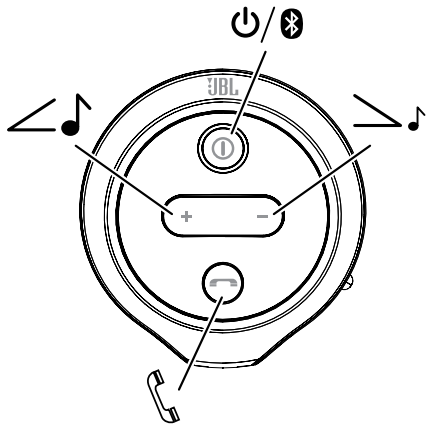

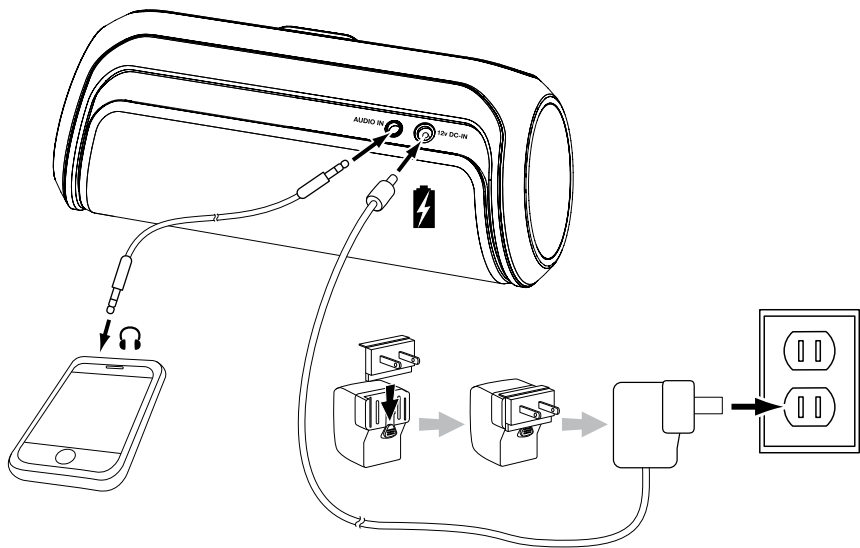



1.

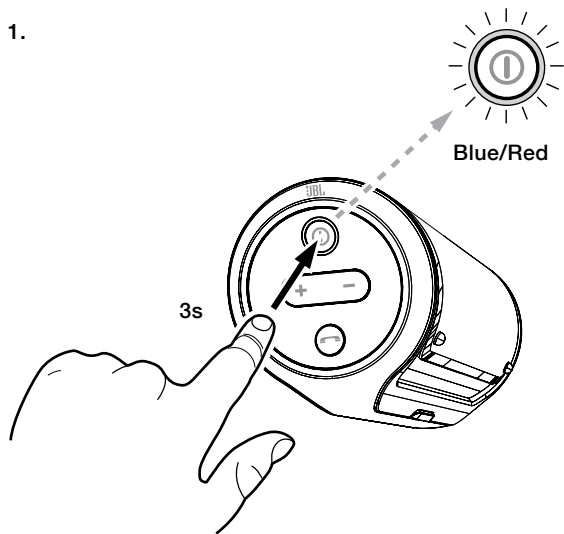

2.

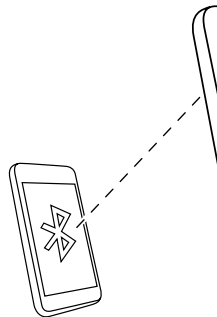

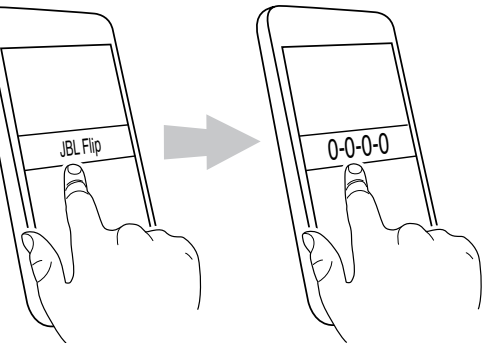

3.

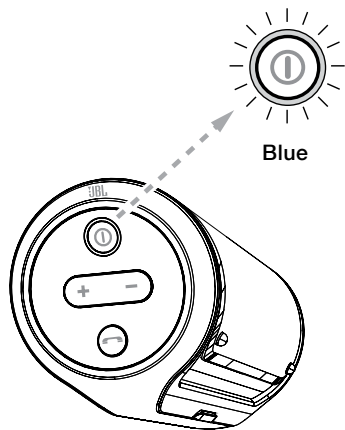



PUHELIMEN NÄPPÄINTEN KÄYTTÖ

		
TILA	LYHYT PAINALLUS	PITKÄ PAINALLUS
Ei puhelua	N/A	Siirry äänentallennustilaan
Lähtevää puhelua näppäilyssä	Lopeta	Lopeta
Saapuva puhelu #1	Vastaa puheluun	Hylkää puhelu
Puhelun aikana	Lopeta	Siirrä puhelu Flipistä puhelimeen
Saapuva puhelu #2	Laita puhelu #1 pitoon ja vastaa puheluun #2	Hylkää puhelu #2
Puhelut #1 ja #2 aktiivisia	Lopeta nykyinen puhelu ja vaihda toiseen puheluun	Vaihtelee puhelujen #1 ja #2 välillä

Функции кнопки телефона

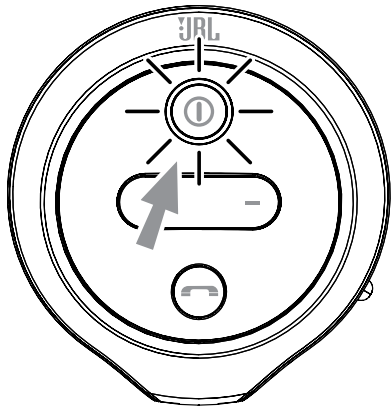
		
УСЛОВИЕ	КОРОТКОЕ НАЖАТИЕ	ДЛИННОЕ НАЖАТИЕ
Нет звонка	нет	Вкл. режим распознавания голоса
Набор исходящего вызова	Отбой	Отбой
Входящий звонок 1	Ответить	Сбросить
Во время звонка	Отбой	Переключить звонок с устройства на телефон
Входящий звонок 2	Перевести звонок 1 в режим ожидания; ответить на звонок 2	Сбросить звонок 2
Оба звонка (1 и 2) активны	Завершить текущий звонок; переключиться на другой звонок	Переключиться между звонком 1 и звонком 2



Blue = 

Red = 

Blue/Red (flashing) = 

 Blue	 Red	 Blue/Red (flashing)
Bleu	Rouge	Bleu (clignotant)
Azul	Rojo	Azul (intermitente)
Azul	Vermelha	Azul (piscando)
Blau	Rot	Blau (blinken)
Blu	Rosso	Blu (lampeggiante)
Blauw	Rood	Blauw (knippen)
Blå	Rød	Blå (blinkende)
Sininen	Punainen	Sininen (vilkkuu)
Blått	Rött	Blått (blinkande)
Blå	Rød	Blå (blinkende)
Синий	Красный	Синий (мигающий)
青	赤	青 (点滅する)
藍色	紅色	藍色／紅色 (閃爍)
蓝色	红色	蓝色 (閃爍)
파란색	빨간색	파란색 (점멸)

SPECIFICATIONS

Transducers: 2 x 1-1/2" (38mm)

Amplifier power: 2 x 5W

Frequency response: 150Hz – 20kHz

Signal-to-noise ratio: >80dB

Battery type: Li-ion rechargeable
7.4V, 1000mAh

Bluetooth transmitter
frequency range: 2.402 – 2.480GHz

Bluetooth transmitter
power: 0 ~ 20dBm

Bluetooth transmitter
modulation: GFSK

Listening time on battery
power: >5 hours

Battery charge time: 3 hours

Dimensions (Dia x H): 63mm x 160mm
(2-7/16" x 6-5/16")

SPECIFICATIONS

Transducteurs : 2 x 1-1/2 po (38mm)

Puissance d'amplificateur : 2 x 5W

Courbe de résonance : 150Hz – 20kHz

Rapport signal sur bruit : >80dB

Type de batterie : Li-ion rechargeable
7.4V, 1000mAh

Plage de fréquence de
l'émetteur *Bluetooth* : 2.402 – 2.480GHz

Puissance de l'émetteur
Bluetooth : 0 ~ 20dBm

Modulation de l'émetteur
Bluetooth : GFSK

Autonomie d'écoute : > 5 heures

Durée de charge : 3 heure

Dimensions (Dia x H) : 63mm x 160mm
(2-7/16 po x 6-5/16 po)

TEKNISET TIEDOT

Anturit: 2 x 1-1/2" (38mm)

Vahvistinteho: 2 x 5W

Taajuusvaste: 150Hz – 20kHz

Äänentoisto: >80dB

Paristo: Li-ion
7.4V, 1000mAh

Bluetooth-lahettimen
taajuusalue: 2.402 – 2.480GHz

Bluetooth-lahettimen teho: 0 ~ 20dBm

Bluetooth-lahettimen
modulaatio: GFSK

Kuuntelu-aika
paristokäytöllä: > 5 tuntia

Pariston latausaika: 3 tuntia

Mitat (Halk. x K): 63mm x 160mm
(2-7/16 tuumaa x
6-5/16 tuumaa)

ТЕХНИЧЕСКИЕ ХАРАКТЕРИСТИКИ

Динамики: 2 x 1-1/2" (38mm)

Мощность усилителя: 2 x 5Вт

Частотная характеристика: 150Гц – 20кГц

Отношение сигнал/шум: >80дБ

Тип аккумулятора: Литий-ионный
перезаряжаемый
7.4V, 1000mAh

Диапазон частот передатчика
Bluetooth: 2.402 – 2.480GHz

Мощность передатчика
Bluetooth: 0 – 20dBm

Модуляция передатчика
Bluetooth: GFSK

Время звучания от
аккумулятора: >5 часов

Время зарядки аккумулятора: 3 часа

Размеры (Диаметр x В): 63mm x 160mm
(2-7/16" x 6-5/16")



HARMAN

HARMAN International Industries, Incorporated
8500 Balboa Boulevard, Northridge,
CA 91329 USA
www.jbl.com

© 2012 HARMAN International Industries, Incorporated. All rights reserved.
JBL is a trademark of HARMAN International Industries, Incorporated,
registered in the United States and/or other countries. The *Bluetooth* word
mark and logos are owned by the *Bluetooth* SIG, Inc. and any use of such
marks by HARMAN International Industries, Incorporated is under license.

Features, specifications and appearance are subject to change without notice.

Part #: 950-0474-001 Rev. A